

HiP

High Purity Fittings





High Pressure Equipment

Table of Contents

1

General Information

valve design • valve selector guide • catalog numbering system • warranty • terms

2

Low Pressure Valves, Fittings and Tubing - 10,000 and 15,000 psi service

Taper Seal - valves • fittings • line filters • check valves • safety heads • rupture discs • tubing • connection details
NPT - valves • fittings • couplings • bulkheads • caps • line filters • check valves • safety heads • rupture discs

3

Medium Pressure Valves, Fittings and Tubing - 20,000 psi service

valves • fittings • unions • bulkheads • caps • line filters • check valves • safety heads • rupture discs
anti-vibration gland assemblies • tubing • coned and threaded nipples • connection details

4

High Pressure Valves, Fittings and Tubing - 30,000, 40,000 and 60,000 psi service

valves • fittings • unions • bulkheads • caps • line filters • check valves • safety heads • rupture discs
anti-vibration gland assemblies • tubing • coned and threaded nipples • connection details

5

Ultra High Pressure Valves, Fittings and Tubing - 100,000 and 150,000 psi service

valves • fittings • check valves • tubing • coned and threaded nipples • connection details

6

Specialty Valves

ball valves • hastelloy valves • high temperature valves • metering valves • relief valves
male bottom connection valves • block and bleed valves • subsea ball valves

7

Air Operated Valves

Mini-Hippo piston operators • Hipco diaphragm operators • Remarco diaphragm operators
Hippo piston operators • Remetco piston operated fine metering valves

8

Accessories

female to male adapters • male to male adapters • NPT and hose fittings • female to female couplings
thermocouple adapters pressure gauges

9

Tooling

reseating tools • coning tools • threading tools • coning and threading instructions

10

Pressure Vessels and Reactors

O-ring seal reactors- series OC • confined gasket closure reactors-series GC • bolted closure reactors
clover leaf reactors • O-ring closure reactors-series R • tubular reactors-series TOC • micro reactors-series MS

11

Pumping Systems, Intensifiers, Gas Boosters and High Pressure Generators

pumping systems • intensifiers • gas boosters • high pressure generators

12

Technical Information

conversion tables • packing options • min. safety hold down nut torque • min. bend radius for high pressure tubing • flow coefficients • pressure ratings of bolted closure reactors • recommended torque • max. recommended volumetric flow rate • pressure rating reduction • graphs

13

Oil and Gas Products

valves • fittings • line filters • check valves • tubing

This is an interactive PDF. At the top of each page, clicking on the **HiP logo** will bring you back to the main table of contents (p 2). Interested in going to HiP's website? Click "**High Pressure Equipment Company**" at the bottom of every right-hand page.



High Pressure Equipment

General Information

High Pressure Equipment Company has developed an extensive line of components and systems designed to satisfy the unique requirements of elevated pressure applications. Since our founding in 1954, we have been singularly focused upon this market segment and have consistently committed the resources necessary to be the industry's most reliable and economical source for quality high pressure products.

This dedication to excellence within our core business has earned HiP preferred supplier status within diverse markets such as waterjet cutting and cleaning, oil and gas, chemical and petrochemical, research and development, universities, government, and general industry.

Our product line includes a complete offering of valves, fittings, tubing, gauges, safety devices, pressure vessels, reactors, pumping systems, intensifiers, gas boosters and pressure generators for use at pressures through 150,000 psi. Stainless steel is the material most commonly used for our standard products, although we offer a variety of other materials to address alternative operating conditions.

We maintain a significant inventory of many standard components, allowing us to provide fast response and delivery to our customers. For special requirements, our flexible structure and skilled machinists will produce a component or system designed to your individual specifications, in a timely manner.

Index

Page

| | |
|------------------------------------|-----|
| Valve Design | 1.2 |
| Valve Selector Guide | 1.3 |
| Catalog Numbering System | 1.4 |
| Warranty & Terms | 1.5 |





High Pressure Equipment

Valve Design

General

- Valve bodies through 100,000 psi are high tensile Type 316 stainless steel, 150,000 psi valve bodies are 17-4 PH stainless steel.
- Stem assemblies have non-rotating tips to prevent galling with valve seats.
- Packing is located below the stem threads to prevent contact with media (liquid or gas).
- Packing glands are equipped with locking devices or lock nuts.
- Six valve patterns (see chart on page 1.3).
- Tubing connections are: $\frac{1}{16}$ " , $\frac{1}{8}$ " , $\frac{1}{4}$ " , $\frac{3}{8}$ " , $\frac{9}{16}$ " , $\frac{3}{4}$ " , and 1". Pipe connections include: $\frac{1}{8}$ " , $\frac{1}{4}$ " , $\frac{3}{8}$ " , $\frac{1}{2}$ " , $\frac{3}{4}$ " , and 1" NPT.
- Remote control air operators are available for most valves.

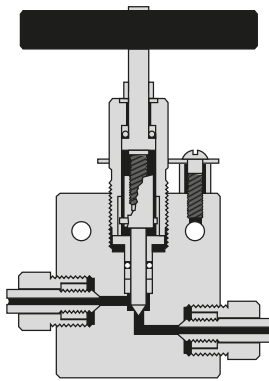

Positive Guide Stem

Positive Guide Stem: High Pressure Equipment Company's patented "Positive Guide" stem assembly virtually eliminates lower stem rotation — one of the most common causes of premature stem failure. The lower section stem is manufactured from hardened 17-4 PH stainless steel for exceptional wear and corrosion resistance and can be easily serviced with no special tooling required. The one-piece upper section stem eliminates the need for continual adjustment and minimizes "loose handle" backlash.

The Positive Guide Stem is standard for all AF4, AF6, HF4, HF6, and HF9 valves, and 60,000 psi HF2 valves.

Rolled Style Stem: This simple two-piece design is also non-rotating and is ideal for smaller valves and for valves made from exotic materials. The standard lower section stem is manufactured from hardened 17-4 PH stainless steel. It is affixed to a one-piece upper stem requiring no periodic adjustment. The two stem components are free to rotate independently of each other, thereby minimizing rotation of the lower stem against the valve seat.

The Rolled Style Stem is standard for all AF1, AF2, NFA, NFB, LF4, LF6 valves, 30,000 psi HF2, XF4, and XF6 valves, as well as most valves requiring stems made from exotic materials. It is optional for any valve normally supplied with a Positive Guide Stem.

Pinned Stem Design: This variation on the Rolled Style Stem is a three-piece design in which the lower stem is pinned into a freely-rotating stem guide. It has all of the advantages of the rolled style stem, with the additional benefit of a replaceable lower section stem.

The Pinned Stem Design is standard for all NFC, NFD, NFF, NFH, LF9, LF12, LF16, and HF16 valves.

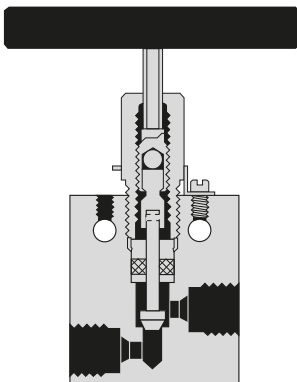

Pinned Stem

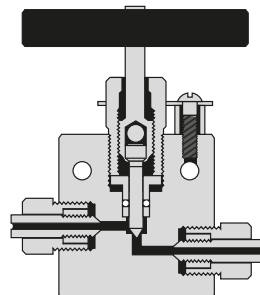

Rolled Style Stem

Quick Selector Guide to Standard Valves

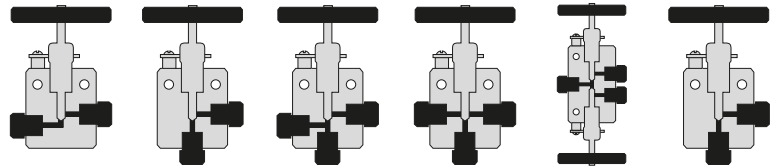
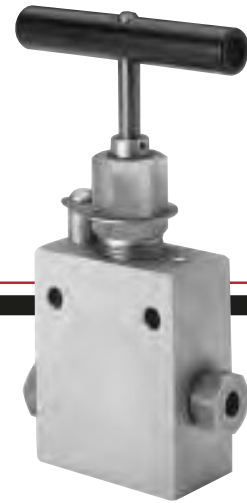

Taper Seal Valves

| | Tubing Size | | Two Way Straight | Two Way Angle | Three Way Two Press | Three Way One Press | Three Way Two Stem | Replaceable Seat |
|-------------|-------------|--------|------------------|---------------|---------------------|---------------------|--------------------|------------------|
| | O.D. | I.D. | | | | | | |
| 10,000 psi | 1/4" | 1/8" | 10-11AF4 | 10-12AF4 | 10-13AF4 | 10-14AF4 | 10-15AF4 | NA |
| | 3/8" | 1/4" | 10-11AF6 | 10-12AF6 | 10-13AF6 | 10-14AF6 | 10-15AF6 | NA |
| 15,000 psi | 1/16" | .030" | 15-11AF1 | 15-12AF1 | 15-13AF1 | 15-14AF1 | 15-15AF1 | NA |
| | 1/8" | 1/16" | 15-11AF2 | 15-12AF2 | 15-13AF2 | 15-14AF2 | 15-15AF2 | NA |
| 20,000 psi | 1/4" | 7/64" | 20-11LF4 | 20-12LF4 | 20-13LF4 | 20-14LF4 | 20-15LF4 | 20-12LF4R |
| | 3/8" | 13/64" | 20-11LF6 | 20-12LF6 | 20-13LF6 | 20-14LF6 | 20-15LF6 | 20-12LF6R |
| | 9/16" | 5/16" | 20-11LF9 | 20-12LF9 | 20-13LF9 | 20-14LF9 | 20-15LF9 | 20-12LF9R |
| | 3/4" | 33/64" | 20-11LF12 | 20-12LF12 | 20-13LF12 | 20-14LF12 | 20-15LF12 | 20-12LF12R |
| | 1" | 11/16" | 20-11LF16 | 20-12LF16 | 20-13LF16 | 20-14LF16 | 20-15LF16 | 20-12LF16R |
| 30,000 psi | 1/8" | .040" | 30-11HF2 | 30-12HF2 | 30-13HF2 | 30-14HF2 | 30-15HF2 | 30-12HF2R |
| | 1/4" | .083" | 30-11HF4 | 30-12HF4 | 30-13HF4 | 30-14HF4 | 30-15HF4 | 30-12HF4R |
| | 3/8" | 1/8" | 30-11HF6 | 30-12HF6 | 30-13HF6 | 30-14HF6 | 30-15HF6 | 30-12HF6R |
| | 9/16" | 3/16" | 30-11HF9 | 30-12HF9 | 30-13HF9 | 30-14HF9 | 30-15HF9 | 30-12HF9R |
| | 1" | .437" | 30-11HF16 | 30-12HF16 | 30-13HF16 | 30-14HF16 | 30-15HF16 | 30-12HF16R |
| 60,000 psi | 1/8" | .020" | 60-11HF2 | 60-12HF2 | 60-13HF2 | 60-14HF2 | 60-15HF2 | 60-12HF2R |
| | 1/4" | 1/16" | 60-11HF4 | 60-12HF4 | 60-13HF4 | 60-14HF4 | 60-15HF4 | 60-12HF4R |
| | 3/8" | 1/8" | 60-11HF6 | 60-12HF6 | 60-13HF6 | 60-14HF6 | 60-15HF6 | 60-12HF6R |
| | 9/16" | 3/16" | 60-11HF9 | 60-12HF9 | 60-13HF9 | 60-14HF9 | 60-15HF9 | 60-12HF9R |
| 100,000 psi | 1/4" | 1/16" | 100-11XF4 | 100-12XF4 | 100-13XF4 | 100-14XF4 | NA | 100-12XF4R |
| 150,000 psi | 3/8" | 1/16" | 150-11XF6 | 150-12XF6 | 150-13XF6 | 150-14XF6 | NA | 150-12XF6R |

Medium Pressure Valves

High Pressure Valves

Ultra High Pressure Valves



High Pressure Equipment

Catalog Numbering System

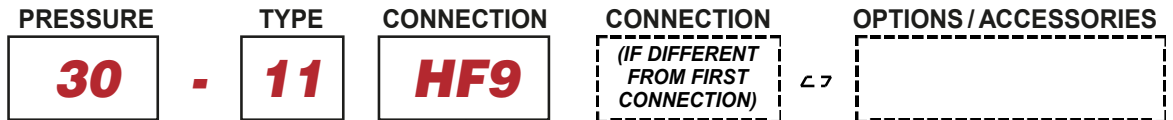

Pressure Series

- 10** = 10,000 psi
- 15** = 15,000 psi
- 20** = 20,000 psi
- 30** = 30,000 psi
- 40** = 40,000 psi
- 60** = 60,000 psi
- 100** = 100,000 psi
- 150** = 150,000 psi

Catalog part numbers for some components (NPT fittings, special alloy parts) have been maintained for historical consideration.

The referred pressure series may not reflect the actual pressure rating. Please refer to applicable catalog page for pressure rating, or consult the factory.

Type of Components

- 2** = Gland, Collar or Sleeve
- 3** = Anti-Vibration Assembly
- 7** = Plug
- 11** = 2-Way Straight Valve
- 12** = 2-Way Angle Valve
- 13** = 3-Way Valve with Two Pressure Connections
- 14** = 3-Way Valve with One Pressure Connections
- 15** = 3-Way, 2-Stem Valve
- 16** = Ball Valve (Floating)
- 21** = Coupling or Adapter
- 22** = Elbow
- 23** = Tee
- 24** = Cross
- 41** = Check Valve
- 51** = Line Filter
- 61** = Safety Head (Straight)
- 63** = Safety Head (Tee Type)
- 71** = 2-Way Ball Valve *
- 72** = 3-Way Ball Valve 180° *
- 73** = 3-Way Ball Valve Diverter *
- 74** = 2-Way Ball Valve *
- 75** = 3-Way Ball Valve 180° *
- 76** = 3-Way Ball Valve Diverter *
- 77** = 3-Way Mini Ball Valve 1/4 NPT
- 80** = 2-Way Ball Valve *
- 81** = 3-Way Ball Valve 180° *
- 82** = 3-Way Ball Valve Diverter *

* (Trunion)

Connection(s) Size and Type

| Female | Male | |
|-------------|-------------|--------------------------|
| AF1 | AM1 | 1/16" Taper Seal |
| AF2 | AM2 | 1/8" Taper Seal |
| AF4 | AM4 | 1/4" Taper Seal |
| AF6 | AM6 | 3/8" Taper Seal |
| LF4 | LM4 | 1/4" Medium Pressure |
| LF6 | LM6 | 3/8" Medium Pressure |
| LF9 | LM9 | 9/16" Medium Pressure |
| LF12 | LM12 | 3/4" Medium Pressure |
| LF16 | LM16 | 1" Medium Pressure |
| HF2 | HM2 | 1/8" High Pressure |
| HF4 | HM4 | 1/4" High Pressure |
| HF6 | HM6 | 3/8" High Pressure |
| HF9 | HM9 | 9/16" High Pressure |
| HF16 | HM16 | 1" High Pressure |
| XF4 | XM4 | 1/4" Ultra High Pressure |
| XF6 | XM6 | 3/8" Ultra High Pressure |
| NFA | NMA | 1/8" NPT Pipe |
| NFB | NMB | 1/4" NPT Pipe |
| NFC | NMC | 3/8" NPT Pipe |
| NFD | NMD | 1/2" NPT Pipe |
| NFF | NMF | 3/4" NPT Pipe |
| NFH | NMH | 1" NPT Pipe |
| — | HA9 | 9/16" Hose |
| — | HA12 | 3/4" Hose |
| — | HA16 | 1" Hose |
| — | HA21 | 1 5/16" Hose |

Options

- V** = Micro Control Metering Assembly (See page 6.5)
- HT** = High Temperature Stem Extension (Up to 1,000° F) (See page 6.4)
- SGS** = Sour Gas (H₂S) Service
- N/O** = Normally Open
- N/C** = Normally Closed
- K** = With Antivibration Collars and Glands
- REG** = Regulating Tip
- TSR8** = Ball Valve Actuator
- TDA8** = Ball Valve Actuator Double Acting
- W/O** = Without Collars and Glands
- LT** = Low Temperature Stem Extension (to -320°F)
- MPO-NO** = Medium Duty Piston Operator Normally Open
- MPO-NC** = Medium Duty Piston Operator Normally Closed
- HPO-NO** = Heavy Duty Piston Operator Normally Open
- HPO-NC** = Heavy Duty Piston Operator Normally Closed
- EHPO-NO** = Extra Heavy Piston Operator Normally Open
- EHPO-NC** = Extra Heavy Piston Operator Normally Closed

How to Order Valves and Fittings

Simply indicate catalog number and specify option or special requirement.

Examples:

30-11HF4 = 30,000 psi Straight Valve for 1/4" O.D. tubing

60-23HF4 = 60,000 psi Tee for 1/4" O.D. tubing

15-21AF2 = 15,000 psi Straight Coupling for 1/8" O.D. tubing, Taper Seal connections

15-21AF2NMB = 15,000 psi Adapter with one end 1/8" O.D. Female Taper Seal and opposite end Male 1/4" NPT Pipe

30-11HF6-HT = 30,000 psi Straight Valve for 3/8" O.D. tubing with High Temperature Extension

"HIPCO" 10-12NFB (N/C) = 10,000 psi Angle Valve for 1/4" NPT Pipe with "Hipco" Air Operator, Normally Closed

"HIPPO" 15-11A4F (N/C) = 10,000 psi Angle Valve for 1/4" Taper Seal with "Hippo" Piston Operator, Normally Closed

60-21HF4 (Hastelloy C-276) = 60,000 psi Straight Coupling for 1/4" O.D. tubing, made from Hastelloy C-276 material

Warranty

High Pressure Equipment Company warrants the products which it manufactures to be free from defects in material and workmanship which would impair their intended usefulness. This warranty is for a period of one year after the date of shipment. Warranty is limited to the repair or replacement of any item manufactured by High Pressure Equipment Company. High Pressure Equipment Company shall not be liable for any direct or indirect consequential damage arising from a failure or malfunction of the equipment. This warranty further excludes damage, failure or malfunction which is caused by corrosion or erosion common to the material supplied.

Terms: Net 30 for qualified accounts

FOB: Erie, PA - USA



High Pressure Equipment

Low Pressure Valves, Fittings and Tubing

Taper Seal and NPT -10,000 and 15,000 psi service

High Pressure Equipment Company has developed the Taper Seal and NPT lines of products to assure safe and easy plumbing through 15,000 psi. These needle valves, fittings, line filters, check valves, safety heads, rupture discs and tubing are engineered and manufactured to the highest standards of repeatable quality. The reliable performance of these products has made HiP one of the world's leading suppliers of elevated pressure components.



Index - Taper Seal Page

| | |
|-----------------------------|----------|
| Valves | 2.2-2.3 |
| Fittings | 2.4 |
| Line Filters & Check Valves | 2.5 |
| Safety Heads | 2.6 |
| Rupture Discs | 2.7 |
| Tubing | 2.7 |
| Connection Details | 2.A |
| | Appendix |

Index - NPT Page

| | |
|------------------------------|-----------|
| Valves | 2.11-2.12 |
| Fittings | 2.13 |
| Couplings, Bulkheads & Caps | 2.14 |
| Line Filters & Check Valves | 2.15 |
| Safety Heads & Rupture Discs | 2.16 |



High Pressure Equipment

Taper Seal Needle Valves 10,000 and 15,000 psi service

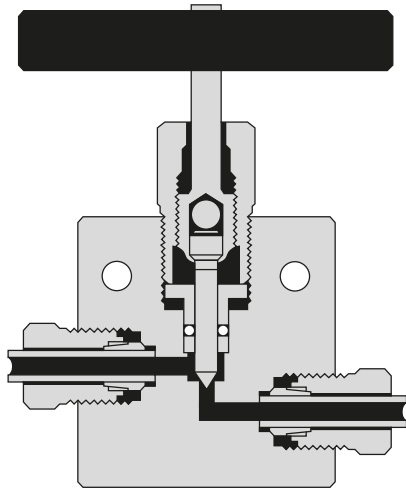

AF1 ($\frac{1}{16}$ ") and AF2 ($\frac{1}{8}$ ")
15,000 psi

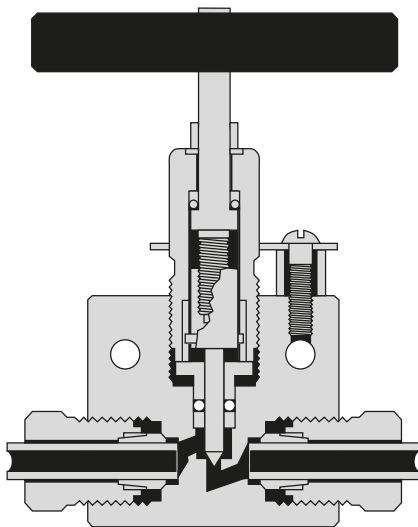

AF4 ($\frac{1}{4}$ ") and AF6 ($\frac{3}{8}$ ")
10,000 psi

Compression type tubing connections for $\frac{1}{16}$ ", $\frac{1}{8}$ ", $\frac{1}{4}$ ", and $\frac{3}{8}$ " O.D. tubing. Requires no special tooling for tubing preparation (simply cut off, deburr, and insert tubing into connection). Connection details are shown on page 2.A.

Non-rotating tip stems are standard for on-off service and insure long life on valve seats. Regulating tip stems are available at no additional cost, add - REG to the catalog number.

Glands and sleeves are supplied with each valve unless otherwise requested (glands and sleeves shown on 2.A).

Materials include high tensile type 316 stainless steel for the valve body and hardened 17-4PH stainless steel lower section stem.

Packing is Teflon (450°F) standard, with optional Viton (350°F), BUNA-N (200°F) or Grafoil (650°F) available at no additional cost.

Air operators for remote control operation are available for all valves. (Select required valve and add "HIPCO". Refer to section 7.0 for additional data).

Valve Features

- Non-rotating stem tips
- Packing below stem threads
- Type 316 ss high tensile bodies
- Positive gland lock device
- No stem adjustment needed
- Black T-handles or choice of 4 colors
- Tube sizes $\frac{1}{16}$ " through $\frac{3}{8}$ "

Taper Seal Valves

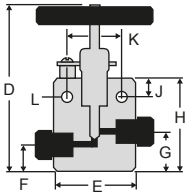

Two Way Straight Valves

| Tubing | Catalog No. | psi | Connection | Orifice | D | E | F | G | H | J | K | L | Thickness |
|------------|-------------|--------|------------|---------|--------|--------|---------|--------|----------|-------|--------|-------|-----------|
| 1/16" O.D. | 15-11AF1 | 15,000 | AF1 | 0.052" | 2 1/2" | 1 1/8" | 1/4" | 13/32" | 1 1/8" | 5/16" | 3/4" | 9/64" | 1/2" |
| 1/8" O.D. | 15-11AF2 | 15,000 | AF2 | 1/16" | 3 1/8" | 1 1/2" | 1 1/16" | 15/16" | 1 13/16" | 5/16" | 7/8" | 9/64" | 3/4" |
| 1/4" O.D. | 10-11AF4 | 10,000 | AF4 | 1/8" | 4 5/8" | 2" | 1/2" | 1/2" | 1 7/8" | 1/2" | 1 3/8" | 7/32" | 1" |
| 3/8" O.D. | 10-11AF6 | 10,000 | AF6 | 1/8" | 4 5/8" | 2" | 1/2" | 1/2" | 1 7/8" | 1/2" | 1 3/8" | 7/32" | 1" |

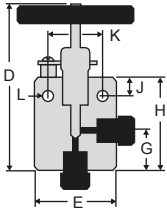

Two Way Angle Valves

| Tubing | Catalog No. | psi | Connection | Orifice | D | E | F | G | H | J | K | L | Thickness |
|------------|-------------|--------|------------|---------|---------|--------|---|---------|----------|-------|--------|-------|-----------|
| 1/16" O.D. | 15-12AF1 | 15,000 | AF1 | 0.052" | 2 5/8" | 1 1/8" | - | 21/32" | 1 3/8" | 5/16" | 3/4" | 9/64" | 1/2" |
| 1/8" O.D. | 15-12AF2 | 15,000 | AF2 | 1/16" | 3 1/8" | 1 1/2" | - | 15/16" | 1 13/16" | 5/16" | 7/8" | 9/64" | 3/4" |
| 1/4" O.D. | 10-12AF4 | 10,000 | AF4 | 1/8" | 5 3/16" | 2" | - | 1 1/16" | 2 7/16" | 1/2" | 1 3/8" | 7/32" | 1" |
| 3/8" O.D. | 10-12AF6 | 10,000 | AF6 | 1/8" | 5 3/16" | 2" | - | 1 1/16" | 2 7/16" | 1/2" | 1 3/8" | 7/32" | 1" |

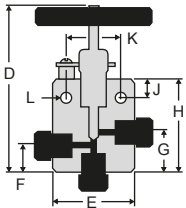

Three Way Valves / Two Pressure Connections

| Tubing | Catalog No. | psi | Connection | Orifice | D | E | F | G | H | J | K | L | Thickness |
|------------|-------------|--------|------------|---------|---------|--------|---------|---------|----------|-------|--------|-------|-----------|
| 1/16" O.D. | 15-13AF1 | 15,000 | AF1 | 0.052" | 2 3/4" | 1 1/8" | 1/2" | 21/32" | 1 3/8" | 5/16" | 3/4" | 9/64" | 1/2" |
| 1/8" O.D. | 15-13AF2 | 15,000 | AF2 | 1/16" | 3 1/8" | 1 1/2" | 1 1/16" | 15/16" | 1 13/16" | 5/16" | 7/8" | 9/64" | 3/4" |
| 1/4" O.D. | 10-13AF4 | 10,000 | AF4 | 1/8" | 5 3/16" | 2" | 1/2" | 1 1/16" | 2 7/16" | 1/2" | 1 3/8" | 7/32" | 1" |
| 3/8" O.D. | 10-13AF6 | 10,000 | AF6 | 1/8" | 5 3/16" | 2" | 1/2" | 1 1/16" | 2 7/16" | 1/2" | 1 3/8" | 7/32" | 1" |

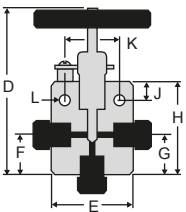

Three Way Valves / One Pressure Connection

| Tubing | Catalog No. | psi | Connection | Orifice | D | E | F | G | H | J | K | L | Thickness |
|------------|-------------|--------|------------|---------|---------|--------|---------|---------|----------|-------|--------|-------|-----------|
| 1/16" O.D. | 15-14AF1 | 15,000 | AF1 | 0.052" | 2 3/4" | 1 1/8" | 21/32" | 21/32" | 1 3/8" | 5/16" | 3/4" | 9/64" | 1/2" |
| 1/8" O.D. | 15-14AF2 | 15,000 | AF2 | 1/16" | 3 1/8" | 1 1/2" | 15/16" | 15/16" | 1 13/16" | 5/16" | 7/8" | 9/64" | 3/4" |
| 1/4" O.D. | 10-14AF4 | 10,000 | AF4 | 1/8" | 5 3/16" | 2" | 1 1/16" | 1 1/16" | 2 7/16" | 1/2" | 1 7/8" | 7/32" | 1" |
| 3/8" O.D. | 10-14AF6 | 10,000 | AF6 | 1/8" | 5 3/16" | 2" | 1 1/16" | 1 1/16" | 2 7/16" | 1/2" | 1 3/8" | 7/32" | 1" |

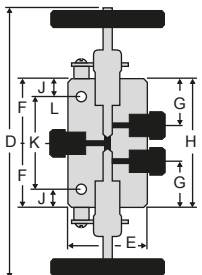

Three Way / Two Stem Connection Valves

| Tubing | Catalog No. | psi | Connection | Orifice | D | E | F | G | H | J | K | L | Thickness |
|------------|-------------|--------|------------|---------|--------|--------|----------|----------|--------|-------|--------|-------|-----------|
| 1/16" O.D. | 15-15AF1 | 15,000 | AF1 | 0.052" | 4 3/4" | 1 1/8" | 1" | 23/32" | 2" | 5/16" | 1 3/8" | 9/64" | 1/2" |
| 1/8" O.D. | 15-15AF2 | 15,000 | AF2 | 1/16" | 5" | 1 1/2" | 1 1/4" | 7/8" | 2 1/2" | 5/16" | 1 7/8" | 9/64" | 3/4" |
| 1/4" O.D. | 10-15AF4 | 10,000 | AF4 | 1/8" | 8 7/8" | 2" | 1 11/16" | 1 1/16" | 3 3/8" | 1/2" | 2 3/8" | 7/32" | 1" |
| 3/8" O.D. | 10-15AF6 | 10,000 | AF6 | 1/8" | 8 7/8" | 2" | 1 11/16" | 1 13/16" | 3 3/8" | 1/2" | 2 3/8" | 7/32" | 1" |



High Pressure Equipment

Glands/Sleeves/Plugs Elbows/Tees/Crosses

A complete range of elbows, tees, and crosses is available for all of the tubing connection sizes. Material is high tensile 316 stainless steel. Standard tubing glands and sleeves are furnished unless otherwise specified.

Connection Components

| Catalog No. | Tube Size | Gland | Catalog No. | Tube Size | Sleeve | Catalog No. | Tube Size | Plug |
|-------------|-----------|-------|-------------|-----------|--------|-------------|-----------|------|
| 15-2AM1 | 1/16" | | 15-2A1 | 1/16" | | 15-7AM1 | 1/16" | |
| 15-2AM2 | 1/8" | | 15-2A2 | 1/8" | | 15-7AM2 | 1/8" | |
| 10-2AM4 | 1/4" | | 10-2A4 | 1/4" | | 10-7AM4 | 1/4" | |
| 10-2AM6 | 3/8" | | 10-2A6 | 3/8" | | 10-7AM6 | 3/8" | |

Taper Seal Elbows

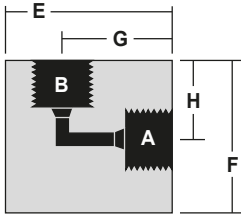

| Catalog No. | Pressure Rating psi | Connections | A-B | E | F | G | H | Thickness |
|-------------|---------------------|-----------------|-----|--------|--------|-------|-------|-----------|
| 15-22AF1 | 15,000 | 1/16" O.D. TUBE | AF1 | 3/4" | 3/4" | 9/16" | 9/16" | 3/8" |
| 15-22AF2 | 15,000 | 1/8" O.D. TUBE | AF2 | 1 1/8" | 1 1/8" | 3/4" | 3/4" | 3/4" |
| 10-22AF4 | 10,000 | 1/4" O.D. TUBE | AF4 | 1 1/2" | 1 1/2" | 1" | 1" | 1" |
| 10-22AF6 | 10,000 | 3/8" O.D. TUBE | AF6 | 1 1/2" | 1 1/2" | 1" | 1" | 1" |

Taper Seal Tees

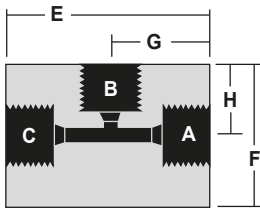

| Catalog No. | Pressure Rating psi | Connections | A-B-C | E | F | G | H | Thickness |
|-------------|---------------------|-----------------|-------|--------|--------|------|-------|-----------|
| 15-23AF1 | 15,000 | 1/16" O.D. TUBE | AF1 | 1" | 3/4" | 1/2" | 9/16" | 3/8" |
| 15-23AF2 | 15,000 | 1/8" O.D. TUBE | AF2 | 1 1/2" | 1 1/8" | 3/4" | 3/4" | 3/4" |
| 10-23AF4 | 10,000 | 1/4" O.D. TUBE | AF4 | 2" | 1 1/2" | 1" | 1" | 1" |
| 10-23AF6 | 10,000 | 3/8" O.D. TUBE | AF6 | 2" | 1 1/2" | 1" | 1" | 1" |

Taper Seal Crosses

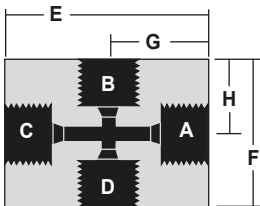

| Catalog No. | Pressure Rating psi | Connections | A-B-C-D | E | F | G | H | Thickness |
|-------------|---------------------|-----------------|---------|--------|--------|------|------|-----------|
| 15-24AF1 | 15,000 | 1/16" O.D. TUBE | AF1 | 1" | 1" | 1/2" | 1/2" | 3/8" |
| 15-24AF2 | 15,000 | 1/8" O.D. TUBE | AF2 | 1 1/2" | 1 1/2" | 3/4" | 3/4" | 3/4" |
| 10-24AF4 | 10,000 | 1/4" O.D. TUBE | AF4 | 2" | 2" | 1" | 1" | 1" |
| 10-24AF6 | 10,000 | 3/8" O.D. TUBE | AF6 | 2" | 2" | 1" | 1" | 1" |

Line Filters

The line filters as shown utilize sintered stainless steel filter discs (AF2 & AF1 – 3 pc./set, AF4 & AF6 – 4 pc./set). Porosities are available as per the chart to the right. If not otherwise specified, 100 micron filter discs are supplied. (One micron = 0.001 millimeters). Material of bodies and end covers is high tensile 316 stainless steel. Standard tubing glands and sleeves are provided unless otherwise specified.

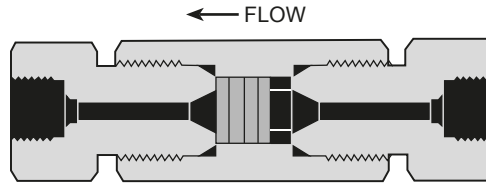

| Catalog No. | Pressure Rating psi | Connections | Length | Hex Size | Micron Size Filter Available | | | | | |
|-------------|---------------------|------------------|--------|----------|------------------------------|---|---|----|----|-----|
| | | | | | 0.5 | 2 | 5 | 10 | 40 | 100 |
| 15-51AF1 | 15,000 | 1/16" TAPER SEAL | 3 1/8" | 3/4" | ● | ● | ● | ● | ● | ● |
| 15-51AF2 | 15,000 | 1/8" TAPER SEAL | 3 1/8" | 3/4" | ● | ● | ● | ● | ● | ● |
| 10-51AF4 | 10,000 | 1/4" TAPER SEAL | 5 1/4" | 1 3/8" | ● | ● | ● | ● | ● | ● |
| 10-51AF6 | 10,000 | 3/8" TAPER SEAL | 5 1/4" | 1 3/8" | ● | ● | ● | ● | ● | ● |

Ball Check Valves

Ball type check valves insure flow in one direction only. Material for bodies, balls, and covers is high tensile 316 stainless steel. Standard tubing glands and sleeves are provided unless otherwise specified.

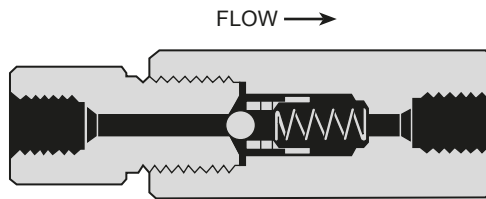

| Catalog No. | psi | Connections | Length | Hex |
|-------------|--------|------------------|---------|-----|
| 15-41AF1 | 15,000 | 1/16" TAPER SEAL | 3 1/8" | 1" |
| 15-41AF2 | 15,000 | 1/8" TAPER SEAL | 3 9/16" | 1" |
| 10-41AF4 | 10,000 | 1/4" TAPER SEAL | 3 7/8" | 1" |
| 10-41AF6 | 10,000 | 3/8" TAPER SEAL | 3 7/8" | 1" |

Soft Seat Check Valves

Soft seat check valves insure flow in one direction only and can be mounted in any position. These are highly reliable for both gas and liquid service. Standard O-ring (soft seat) material for the sealing surface is Buna-N (nitrile) with other materials including Teflon and Viton available on request. Temperature is limited by the choice of O-ring material. Material of all other parts is high tensile 316 stainless steel. Standard glands and sleeves are provided unless otherwise specified.

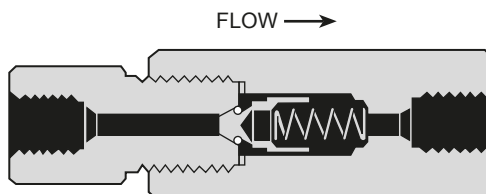

| Catalog No. | psi | Connections | Length | Hex |
|-------------|--------|------------------|--------|-----|
| 15-41AF1-T | 15,000 | 1/16" TAPER SEAL | 3 1/2" | 1" |
| 15-41AF2-T | 15,000 | 1/8" TAPER SEAL | 3 1/2" | 1" |
| 10-41AF4-T | 10,000 | 1/4" TAPER SEAL | 3 7/8" | 1" |
| 10-41AF6-T | 10,000 | 3/8" TAPER SEAL | 3 7/8" | 1" |



High Pressure Equipment

Safety Heads

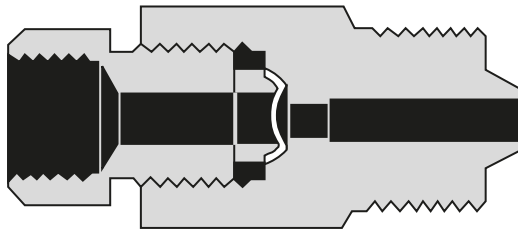

A choice of three safety head designs is available: male inlet, female inlet (straight), and tee type. The male inlet design can be inserted directly into the tubing connections of valves and various fittings such as tees and crosses, or located in pressure vessels.

Outlet connections on all sizes are $\frac{3}{8}$ " pipe (NPT). This outlet may be connected to a suitable discharge line to vent pressure to a safe location in the event of bursting of the rupture disc. Torque required for sealing rupture discs will range from 40 to 60 foot pounds, depending upon pressure and media being used.

Material of bodies and hold down nuts is high tensile 316 stainless steel. Hold down rings are hardened 17-4PH stainless steel. Standard tubing glands and collars (sleeves) are provided unless otherwise specified.

Note: Rupture discs are **not** included and must be ordered as a separate item.



Male Inlet Safety Heads

| Catalog No. | Pressure Rating psi | Inlet Connection | Length | Hex Size |
|-------------|---------------------|----------------------------|-------------------|----------|
| 10-61AM4 | 10,000 | $\frac{1}{4}$ " TAPER SEAL | 2 $\frac{1}{8}$ " | 1" |
| 10-61AM6 | 10,000 | $\frac{3}{8}$ " TAPER SEAL | 2 $\frac{1}{8}$ " | 1" |

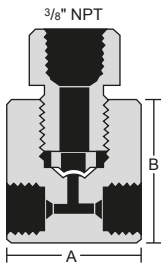

Tee Type Safety Heads

| Catalog No. | Pressure Rating psi | Inlet Connection | A | B | Thickness |
|-------------|---------------------|-----------------------------|-----------------------|-------------------|-------------------|
| 15-63AF1 | 15,000 | $\frac{1}{16}$ " TAPER SEAL | 1 $\frac{1}{8}$ " HEX | 1 $\frac{3}{8}$ " | 1 $\frac{1}{8}$ " |
| 15-63AF2 | 15,000 | $\frac{1}{8}$ " TAPER SEAL | 1 $\frac{1}{2}$ " | 1 $\frac{1}{2}$ " | 1" |
| 10-63AF4 | 10,000 | $\frac{1}{4}$ " TAPER SEAL | 2" | 1 $\frac{3}{4}$ " | 1" |
| 10-63AF6 | 10,000 | $\frac{3}{8}$ " TAPER SEAL | 2" | 1 $\frac{3}{4}$ " | 1" |

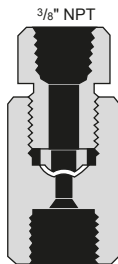

Female Inlet (Straight) Safety Heads

| Catalog No. | Pressure Rating psi | Inlet Connection | Length | Hex Size |
|-------------|---------------------|-----------------------------|-------------------|----------|
| 15-61AF1 | 15,000 | $\frac{1}{16}$ " TAPER SEAL | 1 $\frac{7}{8}$ " | 1" |
| 15-61AF2 | 15,000 | $\frac{1}{8}$ " TAPER SEAL | 1 $\frac{7}{8}$ " | 1" |
| 10-61AF4 | 10,000 | $\frac{1}{4}$ " TAPER SEAL | 1 $\frac{7}{8}$ " | 1" |
| 10-61AF6 | 10,000 | $\frac{3}{8}$ " TAPER SEAL | 1 $\frac{7}{8}$ " | 1" |

Rupture Discs

1/4" Angled Seat



SPECIAL DISCS are available on special order for pressure ranges not shown above and in numerous materials and coatings. Consult factory for price and delivery.

Standard rupture discs are available from stock in burst pressures as listed in the chart below. Taper seal pressures are shaded. These discs are 316 stainless steel (except for 1000 psi which are inconel) and may be used with any of the safety heads shown. Note that these rupture discs are supplied with a tolerance of plus 6% and minus 3% of specified burst pressure. Samples of each batch are then tested and the actual average burst pressure is stamped on an accompanying metal tag. Factors influencing rupture disc life include corrosion, metal fatigue, and cyclic effects. Periodic replacement is recommended to prevent premature failure.

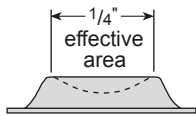

Standard Burst Pressures (in psi at 72°F)

| | | | | | | | | | |
|-------|-------|-------|-------|--------|--------|--------|--------|--------|--------|
| 1,000 | 3,000 | 5,000 | 7,000 | 9,000 | 11,000 | 17,500 | 25,000 | 37,500 | 55,000 |
| 1,500 | 3,500 | 5,500 | 7,500 | 9,500 | 11,500 | 18,000 | 27,000 | 40,000 | 60,000 |
| 2,000 | 4,000 | 6,000 | 8,000 | 10,000 | 12,500 | 20,000 | 30,000 | 45,000 | 65,000 |
| 2,500 | 4,500 | 6,500 | 8,500 | 10,500 | 15,000 | 22,500 | 35,000 | 50,000 | |

High Pressure Tubing

Tubing is cold drawn, seamless, and is supplied in the 1/8 hard condition (not annealed). Tensile strength is approximately 40 percent higher than that of annealed tubing. All tubing is manufactured in strict accordance with High Pressure Equipment Company specifications to insure tolerances and bore quality. Tubing is stocked in lengths of 18 to 22 feet but may be ordered in shorter lengths with **no additional cutting charge**.

Note: The 1/16" and 1/8" O.D. tubing sizes may be coiled for shipment. Larger sizes must be shipped in straight lengths.



| | Tubing Size | Working Pressure psi | Type of Connection Used | Material | Catalog Order Number |
|-------|--------------------------|----------------------|-------------------------|----------|----------------------|
| 1/16" | 1/16" O.D. x 0.006" I.D. | 15,000 | 1/16" TAPER SEAL (AF1) | 316 SS | 15-9A1-006 |
| | 1/16" O.D. x 0.030" I.D. | | | | 15-9A1-030 |
| 1/8" | 1/8" O.D. x 0.060" I.D. | 15,000 | 1/8" TAPER SEAL (AF2) | 316 SS | 15-9A2 |
| 1/4" | 1/4" O.D. x 1/8" I.D. | 10,000 | 1/4" TAPER SEAL (AF4) | 316 SS | 10-9A4-316 |
| | | | | 304 SS | 10-9A4-304 |
| 3/8" | 3/8" O.D. x 1/4" I.D. | 10,000 | 3/8" TAPER SEAL (AF6) | 316 SS | 10-9A6-316 |
| | | | | 304 SS | 10-9A6-304 |



High Pressure Equipment

Taper Seal Connections

10,000 and 15,000 psi service

Taper Seal connections are available for $\frac{1}{16}$ ", $\frac{1}{8}$ ", $\frac{1}{4}$ ", and $\frac{3}{8}$ " O.D. tubing. No special tubing preparation is required – simply cut tubing to desired length, deburr and assemble.

The $\frac{1}{8}$ ", $\frac{1}{4}$ ", and $\frac{3}{8}$ " sizes utilize a two-piece sleeve which is supplied partially assembled. When the connection is assembled, the outer sleeve portion is permanently compressed over the inner portion to rigidly lock the sleeve onto the tubing. Note that the sleeve is not forced to bite into the tubing, but rather is clamped onto the tubing much like a machine collet.

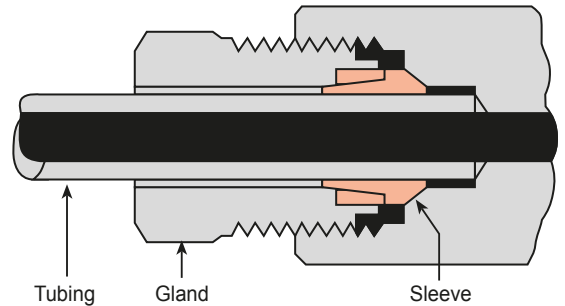

Pressure ratings.

The $\frac{1}{16}$ " and $\frac{1}{8}$ " O.D. tubing size connections are rated to 15,000 psi working pressure. The $\frac{1}{4}$ " and $\frac{3}{8}$ " O.D. sizes are rated to 10,000 psi working pressure.

Easy make-up connections.

One of the popular benefits of taper seal connections is that it is very easy to determine when the connection is "tight enough" during initial assembly. Simply rotate the tubing gland into the connection until you feel a "bottoming out" or "dead stop" of the wrench. This signals that the connection has been properly made.

A commercial thread lubricant is highly recommended to facilitate initial make-up of the connection, but such lubrication may be removed afterwards if desired. The Taper Seal connection can be disassembled and then reassembled an indefinite number of times.

Standard material for the gland is Type 316 stainless steel. The inner portion of the two-piece sleeve is Type 316 stainless steel. The non-wetted outer sleeve portion is zinc plated alloy steel. (Note that the $\frac{1}{16}$ " O.D. size is a one-piece sleeve design) in Type 316 stainless steel.

Tubing glands and sleeves are provided with all valves and fittings unless otherwise requested. (See chart at right for size details and catalog numbers).

| | 15,000 psi | | 10,000 psi | |
|------------------------------|---------------------------------|--------------------------------|--------------------------------|--------------------------------|
| | AF1 1/16" O.D. Tubing | AF2 1/8" O.D. Tubing | AF4 1/4" O.D. Tubing | AF6 3/8" O.D. Tubing |
| Female Opening Detail | | | | |
| Gland | | | | |
| Sleeve | | | | |
| Plug | | | | |
| | 15-7AM1 | 15-7AM2 | 10-7AM4 | 10-7AM6 |

Female NPT/10,000 psi Pipe Connection Valves

1/8" • 1/4" • 3/8" • 1/2" NPT

Non-rotating tip stems are standard for on-off service and insure long life on valve seats. Regulating tip stems are available for all valves at no additional cost.

Materials include high tensile Type 316 stainless steel for valve bodies, and hardened 17-4PH stainless steel for lower section stems.

Packing is Teflon (450°F) standard with optional Viton (350°F), BUNA-N (200°F) and Grafoil (650°F) available at no additional cost.

Air operators for remote control operation are available for all valves. (See Air Operator section of catalog.)

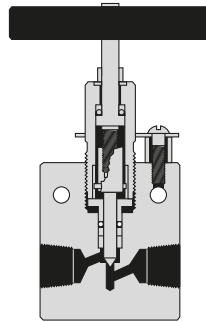

NFA (1/8"), NFB (1/4") and NFC (3/8")

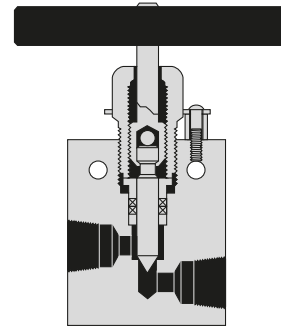

NFD (1/2")

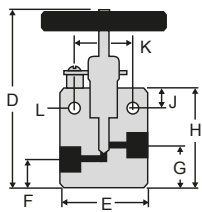

Two Way Straight Valves

| Pipe Size | Catalog No.* | psi | Connection | Orifice | D | E | F | G | H | J | K | L | Thickness |
|-----------|--------------|--------|------------|---------|--------|--------|------|--------|---------|------|--------|-------|-----------|
| 1/8" NPT | 10-11NFA | 10,000 | NFA | 1/8" | 4 3/4" | 2" | 7/8" | 7/8" | 2 7/16" | 1/2" | 1 3/8" | 7/32" | 1" |
| 1/4" NPT | 10-11NFB | 10,000 | NFB | 1/8" | 4 3/4" | 2" | 7/8" | 7/8" | 2 7/16" | 1/2" | 1 3/8" | 7/32" | 1" |
| 3/8" NPT | 10-11NFC | 10,000 | NFC | 1/8" | 4 3/4" | 2" | 7/8" | 7/8" | 2 7/16" | 1/2" | 1 3/8" | 7/32" | 1" |
| 1/2" NPT | 10-11NFD | 10,000 | NFD | 5/16" | 5 5/8" | 2 5/8" | 3/4" | 1 3/8" | 3 1/8" | 1/2" | 1 5/8" | 5/16" | 1 1/2" |

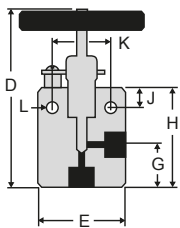

Two Way Angle Valves

| Pipe Size | Catalog No.* | psi | Connection | Orifice | D | E | F | G | H | J | K | L | Thickness |
|-----------|--------------|--------|------------|---------|--------|--------|---|--------|---------|------|--------|-------|-----------|
| 1/8" NPT | 10-12NFA | 10,000 | NFA | 1/8" | 4 3/4" | 2" | — | 1" | 2 7/16" | 1/2" | 1 3/8" | 7/32" | 1" |
| 1/4" NPT | 10-12NFB | 10,000 | NFB | 1/8" | 4 3/4" | 2" | — | 1" | 2 7/16" | 1/2" | 1 3/8" | 7/32" | 1" |
| 3/8" NPT | 10-12NFC | 10,000 | NFC | 1/8" | 4 3/4" | 2" | — | 1" | 2 7/16" | 1/2" | 1 3/8" | 7/32" | 1" |
| 1/2" NPT | 10-12NFD | 10,000 | NFD | 5/16" | 5 3/4" | 2 5/8" | — | 1 1/2" | 3 1/4" | 1/2" | 1 5/8" | 5/16" | 1 1/2" |

* For valves requiring high temperature Grafoil packing in the 1/8" NPT, or 1/4" NPT or 3/8" NPT sizes, add suffix "-W" to catalog number. (Example 10-11NFB-W.)



High Pressure Equipment

Female NPT/10,000 and 15,000 psi Pipe Connection Valves

1/8" • 1/4" • 3/8" • 1/2" NPT • 3/4" NPT • 1" NPT

Non-rotating tip stems are standard for on-off service and insure long life on valve seats. Regulating tip stems are available for all valves at no additional cost.

Materials include high tensile Type 316 stainless steel for valve bodies, and hardened 17-4PH stainless steel for lower section stems.

Packing is Teflon (450°F) standard with optional Viton (350°F), BUNA-N (200°F) and Grafoil (650°F) available at no additional cost.

Air operators for remote control operation are available for all valves. (See Air Operator section of catalog.)

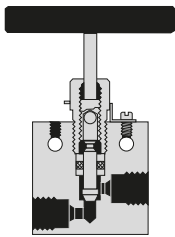

NFA (1/8") and NFB (1/4")

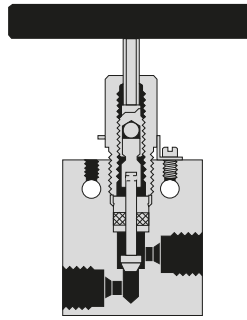

NFC (3/8") and NFD (1/2")

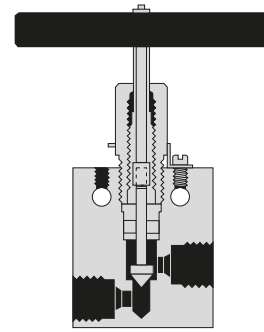

NFF (3/4") and NFH (1")

Two Way Straight Valves

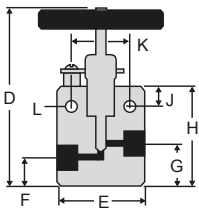

| Pipe Size | Catalog No.* | psi | Connection | Orifice | D | E | F | G | H | J | K | L | Thickness |
|-----------|--------------|--------|------------|---------|---------------------------------|---------------------------------|------|------------------------------------|---------------------------------|---------------------------------|---------------------------------|-----------------------------------|---------------------------------|
| 1/8" NPT | 15F-11NFA | 15,000 | NFA | .203 | 4 ³ / ₈ " | 2" | 3/8" | 13 ¹³ / ₁₆ " | 2" | 3/8" | 1 ¹ / ₄ " | 7 ¹ / ₃₂ " | 3/4" |
| 1/4" NPT | 15F-11NFB | 15,000 | NFB | .203 | 4 ³ / ₈ " | 2" | 3/8" | 13 ¹³ / ₁₆ " | 2" | 3/8" | 1 ¹ / ₄ " | 7 ¹ / ₃₂ " | 3/4" |
| 3/8" NPT | 15F-11NFC | 15,000 | NFC | .312 | 6 ¹ / ₈ " | 2 ¹ / ₂ " | 1/2" | 1 ¹ / ₈ " | 2 ⁷ / ₈ " | 1/2" | 1 ³ / ₈ " | 11 ¹ / ₃₂ " | 1" |
| 1/2" NPT | 15F-11NFD | 15,000 | NFD | .312 | 6 ³ / ₈ " | 2 ⁵ / ₈ " | 3/4" | 1 ³ / ₈ " | 3 ¹ / ₈ " | 1/2" | 1 ³ / ₈ " | 11 ¹ / ₃₂ " | 1 ¹ / ₂ " |
| 3/4" NPT | 10F-11NFF | 10,000 | NFF | .687 | 8 ¹ / ₂ " | 4 ¹ / ₈ " | 7/8" | 1 ¹³ / ₁₆ " | 4 ⁵ / ₈ " | 1 ¹ / ₈ " | 2 ¹ / ₂ " | 9 ¹ / ₁₆ " | 1 ³ / ₄ " |
| 1" NPT | 10F-11NFH | 10,000 | NFH | .687 | 8 ¹ / ₂ " | 4 ¹ / ₈ " | 7/8" | 1 ¹³ / ₁₆ " | 4 ⁵ / ₈ " | 1 ¹ / ₈ " | 2 ¹ / ₂ " | 9 ¹ / ₁₆ " | 1 ³ / ₄ " |

Two Way Angle Valves

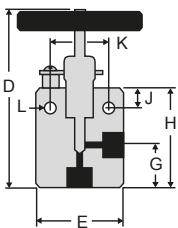

| Pipe Size | Catalog No.* | psi | Connection | Orifice | D | E | F | G | H | J | K | L | Thickness |
|-----------|--------------|--------|------------|---------|-----------------------------------|---------------------------------|---|----------------------------------|----------------------------------|---------------------------------|---------------------------------|-----------------------------------|---------------------------------|
| 1/8" NPT | 15F-12NFA | 15,000 | NFA | .203 | 4 ¹³ / ₁₆ " | 2" | — | 1 ¹ / ₄ " | 2 ⁷ / ₁₆ " | 3/8" | 1 ¹ / ₄ " | 7 ¹ / ₃₂ " | 3/4" |
| 1/4" NPT | 15F-12NFB | 15,000 | NFB | .203 | 4 ¹³ / ₁₆ " | 2" | — | 1 ¹ / ₄ " | 2 ⁷ / ₁₆ " | 3/8" | 1 ¹ / ₄ " | 7 ¹ / ₃₂ " | 3/4" |
| 3/8" NPT | 15F-12NFC | 15,000 | NFC | .312 | 6 ¹ / ₂ " | 2 ¹ / ₂ " | — | 1 ¹ / ₂ " | 3 ³ / ₄ " | 1/2" | 1 ³ / ₈ " | 11 ¹ / ₃₂ " | 1" |
| 1/2" NPT | 15F-12NFD | 15,000 | NFD | .312 | 6 ¹ / ₂ " | 2 ⁵ / ₈ " | — | 1 ¹ / ₂ " | 3 ³ / ₄ " | 1/2" | 1 ³ / ₈ " | 11 ¹ / ₃₂ " | 1 ¹ / ₂ " |
| 3/4" NPT | 10F-12NFF | 10,000 | NFF | .687 | 9" | 4 ¹ / ₈ " | — | 2 ⁵ / ₁₆ " | 5 ⁵ / ₈ " | 1 ¹ / ₈ " | 2 ¹ / ₂ " | 9 ¹ / ₁₆ " | 1 ³ / ₄ " |
| 1" NPT | 10F-12NFH | 10,000 | NFH | .687 | 9" | 4 ¹ / ₈ " | — | 2 ⁵ / ₁₆ " | 5 ⁵ / ₈ " | 1 ¹ / ₈ " | 2 ¹ / ₂ " | 9 ¹ / ₁₆ " | 1 ³ / ₄ " |

* For valves requiring high temperature Grafoil packing in the 1/8" NPT, or 1/4" NPT or 3/8" NPT sizes, add suffix "-W" to catalog number. (Example 10-11NFB-W.)

Elbows/Tees/Crosses

A complete range of elbows, tees, and crosses is available for all of the tubing connection sizes. Material is high tensile 316 stainless steel.

NPT Elbows

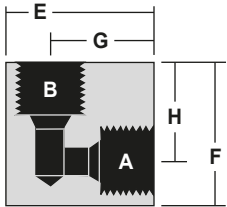

| Catalog No. | Pressure Rating psi | Connections | A-B | E | F | G | H | Thickness |
|-------------|---------------------|-------------|-----|--------|---------|---------|---------|-----------|
| 15-22NFA | 15,000 | 1/8" FNPT | NFA | 1 1/2" | 1 1/2" | 1" | 1" | 3/4" |
| 15-22NFB | 15,000 | 1/4" FNPT | NFB | 1 1/2" | 1 1/2" | 1" | 1" | 1" |
| 15-22NFC | 15,000 | 3/8" FNPT | NFC | 1 1/2" | 1 1/2" | 1" | 1" | 1" |
| 15-22NFD | 15,000 | 1/2" FNPT | NFD | 2 5/8" | 1 7/8" | 1 7/8" | 1 1/8" | 1 1/2" |
| 10-22NFF | 10,000 | 3/4" FNPT | NFF | 2 5/8" | 2 3/16" | 1 5/16" | 1 3/8" | 1 1/2" |
| 10-22NFH | 10,000 | 1" FNPT | NFH | 3" | 3" | 2 1/16" | 2 1/16" | 1 3/4" |

NPT Tees

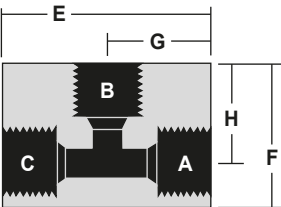

| Catalog No. | Pressure Rating psi | Connections | A-B | E | F | G | H | Thickness |
|-------------|---------------------|-------------|-----|--------|--------|---------|---------|-----------|
| 15-23NFA | 15,000 | 1/8" FNPT | NFA | 1 1/2" | 1 1/4" | 3/4" | 3/4" | 3/4" |
| 15-23NFB | 15,000 | 1/4" FNPT | NFB | 2" | 1 1/2" | 1" | 1" | 1" |
| 15-23NFC | 15,000 | 3/8" FNPT | NFC | 2" | 1 1/2" | 1" | 1" | 1" |
| 15-23NFD | 15,000 | 1/2" FNPT | NFD | 2 5/8" | 2 1/8" | 1 5/16" | 1 3/8" | 1 1/2" |
| 10-23NFF | 10,000 | 3/4" FNPT | NFF | 2 5/8" | 2 1/8" | 1 5/16" | 1 3/8" | 1 1/2" |
| 10-23NFH | 10,000 | 1" FNPT | NFH | 4 1/8" | 3" | 2 1/16" | 2 1/16" | 1 3/4" |

NPT Crosses

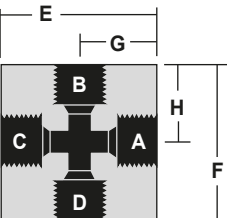

| Catalog No. | Pressure Rating psi | Connections | A-B | E | F | G | H | Thickness |
|-------------|---------------------|-------------|-----|--------|--------|---------|---------|-----------|
| 15-24NFA | 15,000 | 1/8" FNPT | NFA | 1 1/2" | 1 1/2" | 3/4" | 3/4" | 3/4" |
| 15-24NFB | 15,000 | 1/4" FNPT | NFB | 2" | 2" | 1" | 1" | 1" |
| 15-24NFC | 15,000 | 3/8" FNPT | NFC | 2" | 2" | 1" | 1" | 1" |
| 15-24NFD | 15,000 | 1/2" FNPT | NFD | 2 5/8" | 2 3/4" | 1 5/16" | 1 3/8" | 1 1/2" |
| 10-24NFF | 10,000 | 3/4" FNPT | NFF | 2 5/8" | 2 3/4" | 1 5/16" | 1 3/8" | 1 1/2" |
| 10-24NFH | 10,000 | 1" FNPT | NFH | 4 1/8" | 4 1/8" | 2 1/16" | 2 1/16" | 1 3/4" |



High Pressure Equipment

NPT Straight Couplings

Standard material is high tensile 316 stainless steel.



| Catalog No. | Pressure Rating psi | Connections | A-B | Length | Hex |
|-------------|---------------------|-------------|-----|--------|--------|
| 15-21NFA | 15,000 | 1/8" FNPT | NFA | 1 1/4" | 3/4" |
| 15-21NFB | 15,000 | 1/4" FNPT | NFB | 1 3/4" | 1" |
| 15-21NFC | 15,000 | 3/8" FNPT | NFC | 1 3/8" | 1" |
| 15-21NFD | 15,000 | 1/2" FNPT | NFD | 1 7/8" | 1 3/8" |
| 10-21NFF | 10,000 | 3/4" FNPT | NFF | 2 1/2" | 1 3/8" |
| 10-21NFH | 10,000 | 1" FNPT | NFH | 2 1/2" | 1 3/4" |

NPT Bulkhead Couplings

Bulkhead couplings are designed specifically for passing a tubing connection through a panel or steel barricade. These couplings include a locknut as shown. Material is high tensile 316 stainless steel.

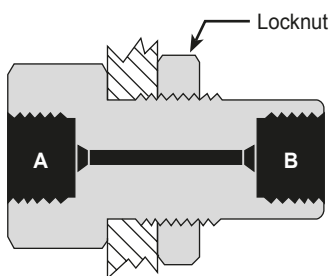

| Catalog No. | Pressure Rating psi | Connections | A-B | Length | Hex | Hole Diameter |
|-------------|---------------------|-------------|-----|--------|--------|---------------|
| 15-21NFA-B | 15,000 | 1/8" FNPT | NFA | 2 1/8" | 1" | 7/8" - 14 |
| 15-21NFB-B | 15,000 | 1/4" FNPT | NFB | 2 1/8" | 1" | 7/8" - 14 |
| 15-21NFC-B | 15,000 | 3/8" FNPT | NFC | 2 3/8" | 1 3/8" | 1 1/16" - 12 |
| 15-21NFD-B | 15,000 | 1/2" FNPT | NFD | 2 3/8" | 1 1/2" | 1 3/8" - 12 |
| 10-21NFF-B | 10,000 | 3/4" FNPT | NFF | 2 5/8" | 1 7/8" | 1 5/8" - 12 |
| 10-21NFH-B | 10,000 | 1" FNPT | NFH | 3 1/2" | 2 1/8" | 1 7/8" - 12 |

NPT Caps

Tubing end caps are offered for use in sealing off tubing ends either for temporary use or permanent use such as on small volume reservoirs. Standard material is high tensile 316 stainless steel.

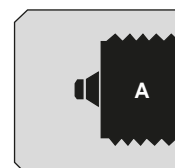

| Catalog No. | Pressure Rating psi | Connections | A-B | Length | Hex |
|-------------|---------------------|-------------|-----|--------|--------|
| 15-21NFA-C | 15,000 | 1/8" FNPT | NFA | 3/4" | 3/4" |
| 15-21NFB-C | 15,000 | 1/4" FNPT | NFB | 1" | 1" |
| 15-21NFC-C | 15,000 | 3/8" FNPT | NFC | 1 1/4" | 1" |
| 15-21NFD-C | 15,000 | 1/2" FNPT | NFD | 1 1/2" | 1 3/8" |
| 10-21NFF-C | 10,000 | 3/4" FNPT | NFF | 1 3/4" | 1 3/8" |
| 10-21NFH-C | 10,000 | 1" FNPT | NFH | 1 3/4" | 1 3/4" |

NPT Line Filters

The line filters as shown utilize sintered stainless steel filter discs 3 pc./set. Porosities are available as per the chart to the right. If not otherwise specified, 100 micron filter discs are supplied. (One micron = 0.001 millimeters). Material of body, caps and cover is high tensile 316 stainless steel.

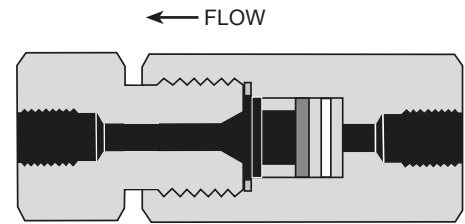

| Catalog No. | Pressure Rating psi | Connections | A-B | Length | Hex | Micron Size Filter Available | | | | | |
|-------------|---------------------|-------------|-----|---------|--------|------------------------------|---|---|----|----|-----|
| | | | | | | 0.5 | 2 | 5 | 10 | 40 | 100 |
| 15-51NFA | 15,000 | 1/8" FNPT | NFA | 3 3/16" | 1 3/8" | • | • | • | • | • | • |
| 15-51NFB | 15,000 | 1/4" FNPT | NFB | 4 3/16" | 1 3/8" | • | • | • | • | • | • |
| 15-51NFC | 15,000 | 3/8" FNPT | NFC | 4 3/16" | 1 3/8" | • | • | • | • | • | • |
| 15-51NFD | 15,000 | 1/2" FNPT | NFD | 4 3/16" | 1 3/8" | • | • | • | • | • | • |

NPT Ball Check Valves

Ball type check valves insure flow in one direction only. Material for body, caps and cover is high tensile 316 stainless steel.

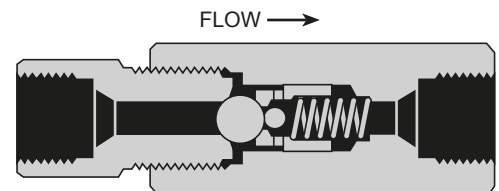

| Catalog No. | Pressure Rating psi | Connections | A-B | Length | Hex |
|-------------|---------------------|-------------|-----|---------|--------|
| 15-41NFA | 15,000 | 1/8" FNPT | NFA | 4 5/32" | 1" |
| 15-41NFB | 15,000 | 1/4" FNPT | NFB | 4 5/32" | 1" |
| 15-41NFC | 15,000 | 3/8" FNPT | NFC | 4 5/32" | 1" |
| 15-41NFD | 15,000 | 1/2" FNPT | NFD | 4 9/16" | 1 3/8" |
| 10-41NFF | 10,000 | 3/4" FNPT | NFF | 5 5/16" | 1 3/8" |
| 10-41NFH | 10,000 | 1" FNPT | NFH | 7 1/8" | 2 1/2" |

NPT Softseat Check Valves

Soft seat check valves insure flow in one direction only and can be mounted in any position. These are highly reliable for both gas and liquid service. Standard O-ring (soft seat) material for the sealing surface is Buna-N (nitrile) with other materials including Teflon and Viton available on request. Temperature is limited by the choice of O-ring material. Material of all other parts is high tensile 316 stainless steel.

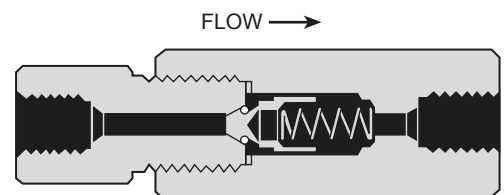

| Catalog No. | Pressure Rating psi | Connections | A-B | Length | Hex |
|-------------|---------------------|-------------|-----|---------|--------|
| 15-41NFA-T | 15,000 | 1/8" FNPT | NFA | 4 5/32" | 1" |
| 15-41NFB-T | 15,000 | 1/4" FNPT | NFB | 4 5/32" | 1" |
| 15-41NFC-T | 15,000 | 3/8" FNPT | NFC | 4 5/32" | 1" |
| 15-41NFD-T | 15,000 | 1/2" FNPT | NFD | 4 9/16" | 1 3/8" |
| 10-41NFF-T | 10,000 | 3/4" FNPT | NFF | 5 5/16" | 1 3/8" |
| 10-41NFH-T | 10,000 | 1" FNPT | NFH | 7 1/8" | 2 1/2" |



High Pressure Equipment

NPT Safety Heads

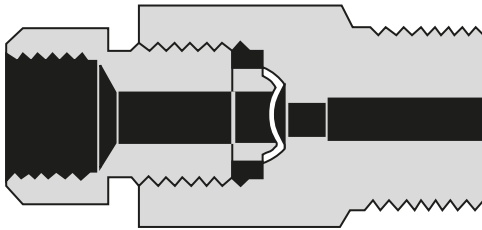

The male inlet design can be inserted directly into the tubing connections of valves and various fittings such as tees and crosses, or located in pressure vessels.

Outlet connections are $\frac{3}{8}$ " pipe (NPT). This outlet may be connected to a suitable discharge line to vent pressure to a safe location in the event of bursting of the rupture disc. Torque required for sealing rupture discs will range from 40 to 90 foot pounds, depending upon pressure and media being used.

Material of body and hold down nut is high tensile 316 stainless steel.

Note: Rupture discs are **not** included and must be ordered as a separate item.

| Catalog No. | psi | Connections | Length | Hex |
|-------------|--------|----------------------|--------|-----|
| 15-61NMA | 15,000 | $\frac{1}{8}$ " MNPT | 2" | 1" |
| 15-61NMB | 15,000 | $\frac{1}{4}$ " MNPT | 2" | 1" |
| 15-61NMC | 15,000 | $\frac{3}{8}$ " MNPT | 2" | 1" |
| 15-61NMD | 15,000 | $\frac{1}{2}$ " MNPT | 2" | 1" |

Rupture Discs

$\frac{1}{4}$ " Angled Seat

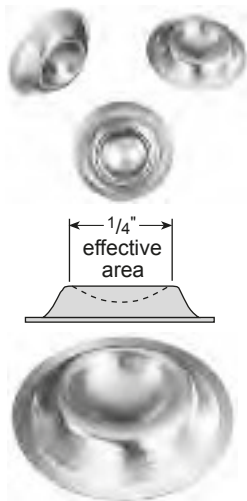

SPECIAL DISCS are available on special order for pressure ranges not shown above and in numerous materials and coatings. Consult factory for price and delivery.

Standard rupture discs are available from stock in burst pressures as listed in the chart below. All pressures through 15,000 psi are shaded. These discs are 316 stainless steel (except for 1,000 psi which are inconel) and may be used with any of the safety heads shown. Note that these rupture discs are supplied with a tolerance of plus 6% and minus 3% of specified burst pressure. Samples of each batch are tested and the actual average burst pressure is stamped on an accompanying metal tag. Factors influencing rupture disc life include corrosion, metal fatigue, and cyclic effects. Periodic replacement is recommended to prevent premature failure.

Standard Burst Pressures (in psi at 72°F)

| | | | | | | | | | |
|-------|-------|-------|-------|--------|--------|--------|--------|--------|--------|
| 1,000 | 3,000 | 5,000 | 7,000 | 9,000 | 11,000 | 17,500 | 25,000 | 37,500 | 55,000 |
| 1,500 | 3,500 | 5,500 | 7,500 | 9,500 | 11,500 | 18,000 | 27,000 | 40,000 | 60,000 |
| 2,000 | 4,000 | 6,000 | 8,000 | 10,000 | 12,500 | 20,000 | 30,000 | 45,000 | 65,000 |
| 2,500 | 4,500 | 6,500 | 8,500 | 10,500 | 15,000 | 22,500 | 35,000 | 50,000 | |



High Pressure Equipment

Medium Pressure Valves, Fittings and Tubing 20,000 psi service

High Pressure Equipment Company has developed a line of Medium Pressure products to assure safe and easy plumbing through 20,000 psi. These needle valves, fittings, line filters, check valves, safety heads, rupture discs, anti-vibration gland assemblies, tubing and nipples are engineered to the highest standards of repeatable quality. The reliable performance of these products has made HiP one of the world's leading suppliers of elevated pressure components.

Medium Pressure components use a compact coned-and-threaded connection which permits the larger bore sizes and increased flow rates common in this pressure class. Medium Pressure valves are available in $\frac{1}{4}$ " , $\frac{3}{8}$ " , $\frac{9}{16}$ " , $\frac{3}{4}$ " , 1" and $1\frac{1}{2}$ " O.D. tubing sizes and five patterns to satisfy widely varied requirements. A line of fittings is available to facilitate adapting to Taper Seal, High Pressure or other threaded pipe systems.



Index

Page

| | |
|---------------------------------|-----------------|
| 20,000 psi Valves* | 3.2-3.3 |
| Fittings | 3.4 |
| Unions, Bulkheads & Caps | 3.5 |
| Line Filters & Check Valves | 3.6 |
| Safety Heads & Rupture Discs | 3.7 |
| Anti-Vibration Gland Assemblies | 3.8 |
| Tubing | 3.9 |
| Coned & Threaded Nipples | 3.9 |
| Connection Details | 3.A Appendix |

*Note: 10,000 psi large orifice is offered in $\frac{3}{4}$ " and 1" size.



High Pressure Equipment

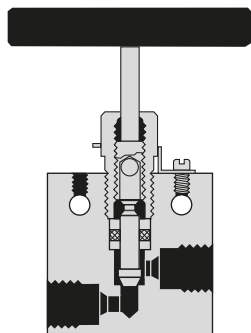

LF4 ($\frac{1}{4}$ ") and LF6 ($\frac{3}{8}$ ")

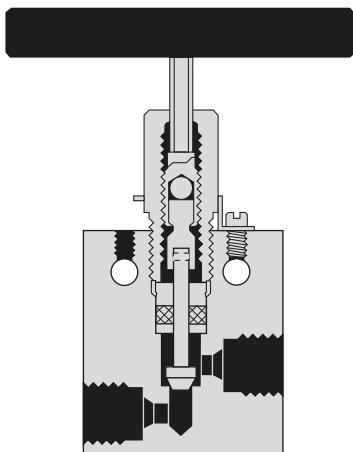

LF9 ($\frac{9}{16}$ ")

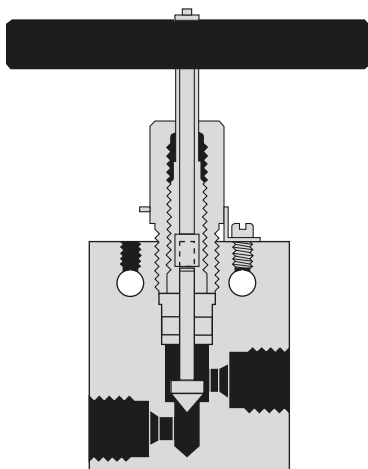

LF12 ($\frac{3}{4}$ ") and LF16 (1")*

20,000 psi Medium Pressure Valves

Medium Pressure (coned & threaded) type connections for $\frac{1}{4}$ " , $\frac{3}{8}$ " , $\frac{9}{16}$ " , $\frac{3}{4}$ " , 1" and $1\frac{1}{2}$ " O.D. tubing.

Non-rotating tip stems are standard for on-off service and insure long life on valve seats. Regulating tip stems are available for all valves at no additional cost, add - REG to part number.

Glands and collars for tubing are supplied with each valve unless otherwise requested (glands and collars shown on pages 3.4 and 3.A).

Materials include high tensile type 316 stainless steel bodies and hardened 17-4PH stainless steel lower section stems.

Packing is Teflon (450°F) standard with optional Viton (350°F), BUNA-N (200°F) and Grafoil (800°F) available at no additional cost.

Air operators for remote control operation are available for all valves. (Select required valve and add "HIPCO". Refer to section 7.0 for additional data).

High temperatures can be accommodated by using extended stuffing boxes (see page 6.6).

Valve Features

- Non-rotating stem tips
- Packing below stem threads
- Type 316 ss high tensile bodies
- Positive gland lock device
- No stem adjustment needed
- Black T-handles or choice of 4 colors
- Tube sizes $\frac{1}{4}$ " through 1"

*Note: 10,000 psi large orifice is offered in $\frac{3}{4}$ " and 1" size.

Two Way Straight Valves

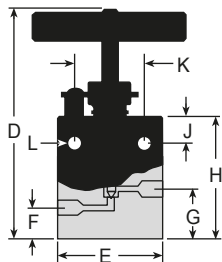

| Tubing | Catalog No. | psi | Connection | Orifice | D | E | F | G | H | J | K | L | Thickness |
|------------|-------------|--------|------------|---------|----------|--------|------|----------|--------|--------|--------|---------|-----------|
| 1/4" O.D. | 20-11LF4 | 20,000 | LF4 | 1/8" | 4 3/8" | 2" | 3/8" | 1 3/16" | 2" | 3/8" | 1 1/4" | 7/32" | 3/4" |
| 3/8" O.D. | 20-11LF6 | 20,000 | LF6 | 13/64" | 4 3/8" | 2" | 3/8" | 1 3/16" | 2" | 3/8" | 1 1/4" | 7/32" | 3/4" |
| 9/16" O.D. | 20-11LF9 | 20,000 | LF9 | 5/16" | 6 1/8" | 2 1/2" | 1/2" | 1 1/8" | 2 7/8" | 1/2" | 1 3/8" | 1 1/32" | 1" |
| 3/4" O.D. | 20-11LF12 | 20,000 | LF12 | 7/16" | 7" | 3" | 3/4" | 1 1/2" | 3 3/4" | 5/8" | 1 3/4" | 7/16" | 1 3/8" |
| 3/4" O.D. | 10-11LF12 | 10,000 | LF12 | 33/64" | 7" | 3" | 3/4" | 1 1/2" | 3 3/4" | 5/8" | 1 3/4" | 7/16" | 1 3/8" |
| 1" O.D. | 20-11LF16 | 20,000 | LF16 | 9/16" | 8 27/64" | 4 1/8" | 7/8" | 1 13/16" | 4 5/8" | 1 1/8" | 2 1/2" | 9/16" | 1 3/4" |
| 1" O.D. | 10-11LF16 | 10,000 | LF16 | 11/16" | 8 27/64" | 4 1/8" | 7/8" | 1 13/16" | 4 5/8" | 1 1/8" | 2 1/2" | 9/16" | 1 3/4" |

Two Way Angle Valves

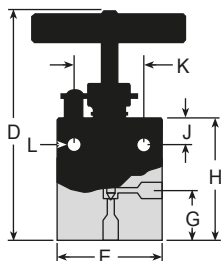

| Tubing | Catalog No. | psi | Connection | Orifice | D | E | F | G | H | J | K | L | Thickness |
|------------|-------------|--------|------------|---------|----------|--------|---|---------|---------|--------|--------|---------|-----------|
| 1/4" O.D. | 20-12LF4 | 20,000 | LF4 | 1/8" | 4 13/16" | 2" | — | 1 1/4" | 2 7/16" | 3/8" | 1 1/4" | 7/32" | 3/4" |
| 3/8" O.D. | 20-12LF6 | 20,000 | LF6 | 13/64" | 4 13/16" | 2" | — | 1 1/4" | 2 7/16" | 3/8" | 1 1/4" | 7/32" | 3/4" |
| 9/16" O.D. | 20-12LF9 | 20,000 | LF9 | 5/16" | 6 5/8" | 2 1/2" | — | 1 5/8" | 3 3/8" | 1/2" | 1 3/8" | 1 1/32" | 1" |
| 3/4" O.D. | 20-12LF12 | 20,000 | LF12 | 7/16" | 7 1/2" | 3" | — | 2" | 4 1/4" | 5/8" | 1 3/4" | 7/16" | 1 3/8" |
| 3/4" O.D. | 10-12LF12 | 10,000 | LF12 | 33/64" | 7 1/2" | 3" | — | 2" | 4 1/4" | 5/8" | 1 3/4" | 7/16" | 1 3/8" |
| 1" O.D. | 20-12LF16 | 20,000 | LF16 | 9/16" | 9 3/8" | 4 1/8" | — | 2 9/16" | 5 7/16" | 1 1/8" | 2 1/2" | 9/16" | 1 3/4" |
| 1" O.D. | 10-12LF16 | 10,000 | LF16 | 11/16" | 9 3/8" | 4 1/8" | — | 2 9/16" | 5 7/16" | 1 1/8" | 2 1/2" | 9/16" | 1 3/4" |

Three Way Valves / Two Pressure Connections

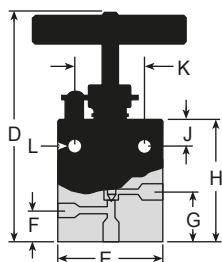

| Tubing | Catalog No. | psi | Connection | Orifice | D | E | F | G | H | J | K | L | Thickness |
|------------|-------------|--------|------------|---------|--------|--------|--------|---------|---------|--------|--------|---------|-----------|
| 1/4" O.D. | 20-13LF4 | 20,000 | LF4 | 1/8" | 5" | 2" | 1" | 1 7/16" | 2 5/16" | 3/8" | 1 1/4" | 7/32" | 3/4" |
| 3/8" O.D. | 20-13LF6 | 20,000 | LF6 | 13/64" | 5" | 2" | 1" | 1 7/16" | 2 5/16" | 3/8" | 1 1/4" | 7/32" | 3/4" |
| 9/16" O.D. | 20-13LF9 | 20,000 | LF9 | 5/16" | 6 7/8" | 2 1/2" | 1 1/4" | 1 7/8" | 3 5/8" | 1/2" | 1 3/8" | 1 1/32" | 1" |
| 3/4" O.D. | 20-13LF12 | 20,000 | LF12 | 7/16" | 7 7/8" | 3" | 2 5/8" | 2 3/8" | 4 5/8" | 5/8" | 1 3/4" | 7/16" | 1 3/8" |
| 3/4" O.D. | 10-13LF12 | 10,000 | LF12 | 33/64" | 7 7/8" | 3" | 2 5/8" | 2 3/8" | 4 5/8" | 5/8" | 1 3/4" | 7/16" | 1 3/8" |
| 1" O.D. | 20-13LF16 | 20,000 | LF16 | 9/16" | 9 3/4" | 4 1/8" | 2 1/8" | 3 1/16" | 5 7/8" | 1 1/8" | 2 1/2" | 9/16" | 1 3/4" |
| 1" O.D. | 10-13LF16 | 10,000 | LF16 | 11/16" | 9 3/4" | 4 1/8" | 2 1/8" | 3 1/16" | 5 7/8" | 1 1/8" | 2 1/2" | 9/16" | 1 3/4" |

Three Way Valves / One Pressure Connection

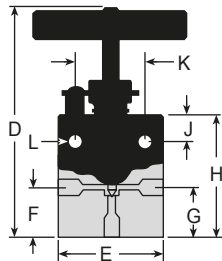

| Tubing | Catalog No. | psi | Connection | Orifice | D | E | F | G | H | J | K | L | Thickness |
|------------|-------------|--------|------------|---------|----------|--------|--------|--------|---------|--------|--------|---------|-----------|
| 1/4" O.D. | 20-14LF4 | 20,000 | LF4 | 1/8" | 4 13/16" | 2" | 1 1/4" | 1 1/4" | 2 7/16" | 3/8" | 1 1/4" | 7/32" | 3/4" |
| 3/8" O.D. | 20-14LF6 | 20,000 | LF6 | 13/64" | 4 13/16" | 2" | 1 1/4" | 1 1/4" | 2 7/16" | 3/8" | 1 1/4" | 7/32" | 3/4" |
| 9/16" O.D. | 20-14LF9 | 20,000 | LF9 | 5/16" | 6 5/8" | 2 1/2" | 1 5/8" | 1 5/8" | 3 3/8" | 1/2" | 1 3/8" | 1 1/32" | 1" |
| 3/4" O.D. | 20-14LF12 | 20,000 | LF12 | 7/16" | 7 1/2" | 3" | 2" | 2" | 4 1/4" | 5/8" | 1 3/4" | 7/16" | 1 3/8" |
| 3/4" O.D. | 10-14LF12 | 10,000 | LF12 | 33/64" | 7 1/2" | 3" | 2" | 2" | 4 1/4" | 5/8" | 1 3/4" | 7/16" | 1 3/8" |
| 1" O.D. | 20-14LF16 | 20,000 | LF16 | 9/16" | 9 3/8" | 4 1/8" | 2 5/8" | 2 5/8" | 5 7/16" | 1 1/8" | 2 1/2" | 9/16" | 1 3/4" |
| 1" O.D. | 10-14LF16 | 10,000 | LF16 | 11/16" | 9 3/8" | 4 1/8" | 2 5/8" | 2 5/8" | 5 7/16" | 1 1/8" | 2 1/2" | 9/16" | 1 3/4" |

Three Way / Two Stem Connection Valves

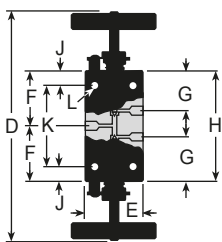

| Tubing | Catalog No. | psi | Connection | Orifice | D | E | F | G | H | J | K | L | Thickness |
|------------|-------------|--------|------------|---------|----------|--------|----------|----------|--------|--------|--------|---------|-----------|
| 1/4" O.D. | 20-15LF4 | 20,000 | LF4 | 1/8" | 5 3/4" | 2" | 1 11/16" | 1 3/16" | 3 3/8" | 3/8" | 1 1/4" | 7/32" | 3/4" |
| 3/8" O.D. | 20-15LF6 | 20,000 | LF6 | 13/64" | 5 3/4" | 2" | 1 11/16" | 1 3/16" | 3 3/8" | 3/8" | 1 1/4" | 7/32" | 3/4" |
| 9/16" O.D. | 20-15LF9 | 20,000 | LF9 | 5/16" | 8 3/8" | 2 1/2" | 2 9/16" | 1 3/4" | 5 1/8" | 1/2" | 1 3/8" | 1 1/32" | 1" |
| 3/4" O.D. | 20-15LF12 | 20,000 | LF12 | 7/16" | 9 3/4" | 3" | 3 3/4" | 2 1/4" | 6 1/2" | 5/8" | 1 3/4" | 7/16" | 1 3/8" |
| 3/4" O.D. | 10-15LF12 | 10,000 | LF12 | 33/64" | 9 3/4" | 3" | 3 3/4" | 2 1/4" | 6 1/2" | 5/8" | 1 3/4" | 7/16" | 1 3/8" |
| 1" O.D. | 20-15LF16 | 20,000 | LF16 | 9/16" | 12 3/16" | 4 1/8" | 4 1/8" | 2 13/16" | 8 1/4" | 1 1/8" | 2 1/2" | 9/16" | 1 3/4" |
| 1" O.D. | 10-15LF16 | 10,000 | LF16 | 11/16" | 12 3/16" | 4 1/8" | 4 1/8" | 2 13/16" | 8 1/4" | 1 1/8" | 2 1/2" | 9/16" | 1 3/4" |

Replaceable Seat Valves

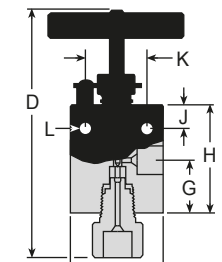

| Tubing | Catalog No. | psi | Connection | Orifice | D | E | F | G | H | J | K | L | Thickness |
|------------|-------------|--------|------------|---------|---------|--------|---|---------|---------|--------|--------|---------|-----------|
| 1/4" O.D. | 20-12LF4-R | 20,000 | LF4 | 1/8" | 5 5/8" | 2" | — | 1 1/4" | 2 7/16" | 3/8" | 1 1/4" | 7/32" | 3/4" |
| 3/8" O.D. | 20-12LF6-R | 20,000 | LF6 | 13/64" | 5 5/8" | 2" | — | 1 1/4" | 2 7/16" | 3/8" | 1 1/4" | 7/32" | 3/4" |
| 9/16" O.D. | 20-12LF9-R | 20,000 | LF9 | 5/16" | 8" | 2 1/2" | — | 1 5/8" | 3 3/8" | 1/2" | 1 3/8" | 1 1/32" | 1" |
| 3/4" O.D. | 20-12LF12-R | 20,000 | LF12 | 7/16" | 8 7/8" | 3" | — | 2" | 4 1/4" | 5/8" | 1 3/4" | 7/16" | 1 3/8" |
| 3/4" O.D. | 10-12LF12-R | 10,000 | LF12 | 33/64" | 8 7/8" | 3" | — | 2" | 4 1/4" | 5/8" | 1 3/4" | 7/16" | 1 3/8" |
| 1" O.D. | 20-12LF16-R | 20,000 | LF16 | 9/16" | 11 1/6" | 4 1/8" | — | 2 9/16" | 5 7/16" | 1 1/8" | 2 1/2" | 9/16" | 1 3/4" |
| 1" O.D. | 10-12LF16-R | 10,000 | LF16 | 11/16" | 11 1/6" | 4 1/8" | — | 2 9/16" | 5 7/16" | 1 1/8" | 2 1/2" | 9/16" | 1 3/4" |



High Pressure Equipment

Glands/Collars/Plugs Elbows/Tees/Crosses

A complete range of elbows, tees, and crosses is available for all of the tubing connection sizes. Material is high tensile 316 stainless steel. Standard tubing glands and collars are provided unless otherwise specified.

Connection Components

| Catalog No. | Tube Size | Gland | Catalog No. | Tube Size | Collar | Catalog No. | Tube Size | Plug |
|-------------|-----------|-------|-------------|-----------|--------|-------------|-----------|------|
| 20-2LM4 | 1/4" | | 20-2L4 | 1/4" | | 20-7LM4 | 1/4" | |
| 20-2LM6 | 3/8" | | 20-2L6 | 3/8" | | 20-7LM6 | 3/8" | |
| 20-2LM9 | 9/16" | | 20-2L9 | 9/16" | | 20-7LM9 | 9/16" | |
| 20-2LM12 | 3/4" | | 20-2L12 | 3/4" | | 20-7LM12 | 3/4" | |
| 20-2LM16 | 1" | | 20-2L16 | 1" | | 20-7LM16 | 1" | |
| 15-2LM24 | 1 1/2" | | 15-2L24 | 1 1/2" | | 15-7LM24 | 1 1/2" | |

Medium Pressure Elbows

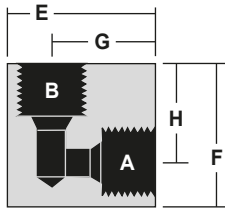

| Catalog No. | Pressure Rating psi | Connections | A-B | E | F | G | H | Thickness |
|-------------|---------------------|------------------|------|---------|--------|---------|---------|-----------|
| 20-22LF4 | 20,000 | 1/4" O.D. TUBE | LF4 | 1 3/16" | 1" | 7/8" | 11/16" | 5/8" |
| 20-22LF6 | 20,000 | 3/8" O.D. TUBE | LF6 | 1 3/8" | 1 3/8" | 1" | 1" | 3/4" |
| 20-22LF9 | 20,000 | 9/16" O.D. TUBE | LF9 | 1 3/4" | 1 3/4" | 1 1/4" | 1 1/4" | 1" |
| 20-22LF12 | 20,000 | 3/4" O.D. TUBE | LF12 | 2 1/4" | 2 1/4" | 1 1/2" | 1 1/2" | 1 3/8" |
| 20-22LF16 | 20,000 | 1" O.D. TUBE | LF16 | 3" | 3" | 2 1/16" | 2 1/16" | 1 3/4" |
| 15-22LF24 | 15,000 | 1 1/2" O.D. TUBE | LF24 | 5 3/4" | 4" | 2 7/8" | 2 7/8" | 2 1/4" |

Medium Pressure Tees

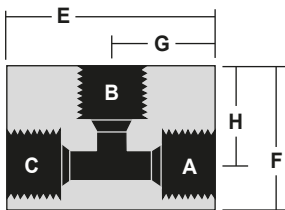

| Catalog No. | Pressure Rating psi | Connections | A-B-C | E | F | G | H | Thickness |
|-------------|---------------------|------------------|-------|--------|--------|---------|---------|-----------|
| 20-23LF4 | 20,000 | 1/4" O.D. TUBE | LF4 | 1 3/4" | 1" | 7/8" | 11/16" | 5/8" |
| 20-23LF6 | 20,000 | 3/8" O.D. TUBE | LF6 | 2" | 1 3/8" | 1" | 1" | 3/4" |
| 20-23LF9 | 20,000 | 9/16" O.D. TUBE | LF9 | 2 1/2" | 1 3/4" | 1 1/4" | 1 1/4" | 1" |
| 20-23LF12 | 20,000 | 3/4" O.D. TUBE | LF12 | 3" | 2 1/4" | 1 1/2" | 1 1/2" | 1 3/8" |
| 20-23LF16 | 20,000 | 1" O.D. TUBE | LF16 | 4 1/8" | 3" | 2 1/16" | 2 1/16" | 1 3/4" |
| 15-23LF24 | 15,000 | 1 1/2" O.D. TUBE | LF24 | 5 3/4" | 4" | 2 7/8" | 2 7/8" | 2 1/4" |

Medium Pressure Crosses

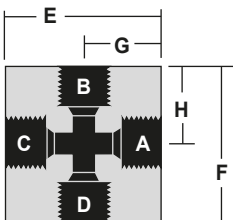

| Catalog No. | Pressure Rating psi | Connections | A-B-C-D | E | F | G | H | Thickness |
|-------------|---------------------|------------------|---------|--------|--------|---------|---------|-----------|
| 20-24LF4 | 20,000 | 1/4" O.D. TUBE | LF4 | 1 3/4" | 1 3/8" | 7/8" | 11/16" | 5/8" |
| 20-24LF6 | 20,000 | 3/8" O.D. TUBE | LF6 | 2" | 2" | 1" | 1" | 3/4" |
| 20-24LF9 | 20,000 | 9/16" O.D. TUBE | LF9 | 2 1/2" | 2 1/2" | 1 1/4" | 1 1/4" | 1" |
| 20-24LF12 | 20,000 | 3/4" O.D. TUBE | LF12 | 3" | 3" | 1 1/2" | 1 1/2" | 1 3/8" |
| 20-24LF16 | 20,000 | 1" O.D. TUBE | LF16 | 4 1/8" | 4 1/8" | 2 1/16" | 2 1/16" | 1 3/4" |
| 15-24LF24 | 15,000 | 1 1/2" O.D. TUBE | LF24 | 5 3/4" | 5 3/4" | 2 7/8" | 2 7/8" | 2 1/4" |

Union Couplings (Slip Type)

Union (slip type) couplings are ideal for use in confined space installations. This design allows the entire coupling to be disconnected and slipped back over the tubing to facilitate assembly and disassembly. In installations where tubing is easily assembled, it is preferable (and less expensive) to use standard straight couplings (see section 8.0). Standard material is high tensile 316 stainless steel. Standard tubing collars and glands are provided unless otherwise specified.

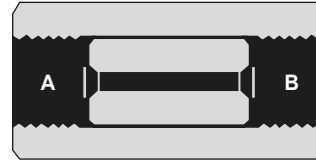

| Catalog No. | Tubing | psi | A | B | Orifice | Length | Hex |
|-------------|-------------|--------|------|------|---------|---------|--------|
| 20-21LF4-U | 1/4" O.D. | 20,000 | LF4 | LF4 | 1/8" | 1 9/16" | 5/8" |
| 20-21LF6-U | 3/8" O.D. | 20,000 | LF6 | LF6 | 7/32" | 1 3/4" | 3/4" |
| 20-21LF9-U | 9/16" O.D. | 20,000 | LF9 | LF9 | 23/64" | 2 1/8" | 1" |
| 20-21LF12-U | 3/4" O.D. | 20,000 | LF12 | LF12 | 33/64" | 2 1/2" | 1 3/8" |
| 20-21LF16-U | 1" O.D. | 20,000 | LF16 | LF16 | 11/16" | 3 1/2" | 1 3/4" |
| 15-21LF24-U | 1 1/2" O.D. | 15,000 | LF24 | LF24 | 15/16" | 5" | 2 1/4" |

Bulkhead Couplings

Bulkhead couplings are designed specifically for passing a tubing connection through a panel or steel barricade. These couplings include a locknut as shown. Material is high tensile 316 stainless steel. Standard tubing collars and glands are included unless otherwise specified.

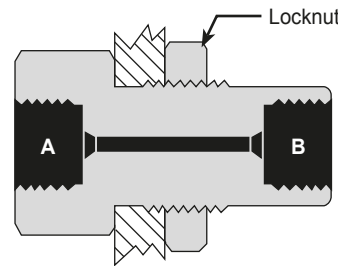

| Catalog No. | Tubing | psi | Connections | Orifice | Length | Hex | Hole Diameter |
|-------------|-------------|--------|-------------|---------|--------|--------|---------------|
| 20-21LF4-B | 1/4" O.D. | 20,000 | LF4 | 1/8" | 1 7/8" | 1" | 13/16" |
| 20-21LF6-B | 3/8" O.D. | 20,000 | LF6 | 7/32" | 2" | 1" | 15/16" |
| 20-21LF9-B | 9/16" O.D. | 20,000 | LF9 | 23/64" | 2 3/8" | 1 3/8" | 1 1/8" |
| 20-21LF12-B | 3/4" O.D. | 20,000 | LF12 | 33/64" | 2 5/8" | 1 7/8" | 1 11/16" |
| 20-21LF16-B | 1" O.D. | 20,000 | LF-16 | 11/16" | 3 1/2" | 2 1/8" | 1 15/16" |
| 15-21LF24-B | 1 1/2" O.D. | 15,000 | LF24 | 15/16" | 5" | 2 1/2" | 2 7/16" |

Caps

Tubing end caps are offered for use in sealing off tubing ends either for temporary use or permanent use, such as on small volume reservoirs. Standard material is high tensile 316 stainless steel. Standard tubing collars and glands are provided unless otherwise specified.

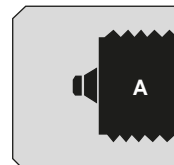

| Catalog No. | Tubing | psi | A | Length | Hex |
|-------------|-------------|--------|------|--------|--------|
| 20-21LF4-C | 1/4" O.D. | 20,000 | LF4 | 7/8" | 5/8" |
| 20-21LF6-C | 3/8" O.D. | 20,000 | LF6 | 1 3/8" | 3/4" |
| 20-21LF9-C | 9/16" O.D. | 20,000 | LF9 | 1 1/2" | 1" |
| 20-21LF12-C | 3/4" O.D. | 20,000 | LF12 | 2 1/2" | 1 3/8" |
| 20-21LF16-C | 1" O.D. | 20,000 | LF16 | 3" | 1 3/4" |
| 15-21LF24-C | 1 1/2" O.D. | 15,000 | LF24 | 3 1/2" | 2 1/4" |



High Pressure Equipment

Line Filters

The line filters as shown utilize sintered stainless steel filter discs 4 pc./set. Porosities are available as per the chart to the right. If not otherwise specified, 100 micron filter discs are supplied. (One micron = 0.001 millimeters). Material of body, caps and cover is high tensile 316 stainless steel. Standard tubing glands and collars are provided unless otherwise specified.

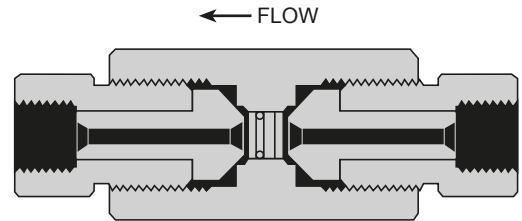

| Catalog No. | Tubing | psi | Connections | Orifice | Length | Thickness | Micron Size Filter Available | | | | | |
|-------------|------------|--------|-------------|---------|--------|-----------|------------------------------|---|---|----|----|-----|
| | | | | | | | 0.5 | 2 | 5 | 10 | 40 | 100 |
| 20-51LF4 | 1/4" O.D. | 20,000 | LF4 | 1/8" | 5 1/4" | 1 3/8" | • | • | • | • | • | • |
| 20-51LF6 | 3/8" O.D. | 20,000 | LF6 | 7/32" | 5 1/4" | 1 3/8" | • | • | • | • | • | • |
| 20-51LF9 | 9/16" O.D. | 20,000 | LF9 | 23/64" | 5 1/4" | 1 3/8" | • | • | • | • | • | • |

Ball Check Valves

Ball type check valves insure flow in one direction only. Material for body, caps and cover is high tensile 316 stainless steel. Standard tubing glands and collars are provided unless otherwise specified.

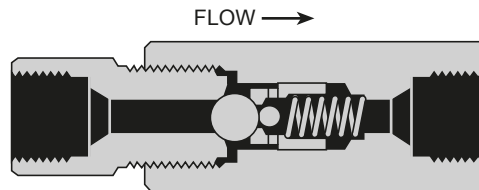

| Catalog No. | Tubing | psi | Connections | Orifice | Length | Thickness |
|-------------|------------|--------|-------------|---------|--------|-----------|
| 20-41LF4 | 1/4" O.D. | 20,000 | LF4 | 1/8" | 3 3/4" | 1" |
| 20-41LF6 | 3/8" O.D. | 20,000 | LF6 | 7/32" | 3 3/4" | 1" |
| 20-41LF9 | 9/16" O.D. | 20,000 | LF9 | 23/64" | 4 1/2" | 1 3/8" |
| 20-41LF12 | 3/4" O.D. | 20,000 | LF12 | 7/16" | 5 1/8" | 1 3/4" |
| 20-41LF16 | 1" O.D. | 20,000 | LF16 | 9/16" | 6 1/2" | 2 1/2" |

Note: 20-41LF16 material 17-4PH

Soft Seat Check Valves

Soft seat check valves insure flow in one direction only and can be mounted in any position. These are highly reliable for both gas and liquid service. Standard material for the sealing surface (soft seat) is Buna-N (nitrile) on 1/4", 3/8" and 9/16" models, and Teflon on 3/4" and 1" models, with other materials (including each of these, as well as Viton) available upon request. Temperature is limited by the choice of O-ring material. Material of all other parts is high tensile 316 stainless steel. Standard glands and collars are provided unless otherwise specified.

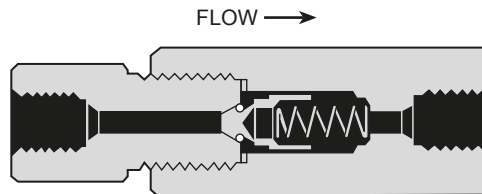

| Catalog No. | Tubing | psi | Connections | Orifice | Length | Thickness |
|-------------|------------|--------|-------------|---------|--------|-----------|
| 20-41LF4-T | 1/4" O.D. | 20,000 | LF4 | 1/8" | 3 3/4" | 1" |
| 20-41LF6-T | 3/8" O.D. | 20,000 | LF6 | 7/32" | 3 3/4" | 1" |
| 20-41LF9-T | 9/16" O.D. | 20,000 | LF9 | 23/64" | 4 1/2" | 1 3/8" |
| 20-41LF12-T | 3/4" O.D. | 20,000 | LF12 | 7/16" | 5 1/8" | 1 3/4" |
| 20-41LF16-T | 1" O.D. | 20,000 | LF16 | 9/16" | 6 1/2" | 2 1/2" |

Note: 20-41LF16 material 17-4PH

Safety Heads

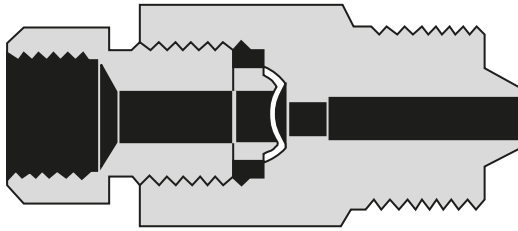

The male inlet design can be inserted directly into the tubing connections of valves and various fittings such as tees and crosses, or located in pressure vessels.

Outlet connections are $\frac{3}{8}$ " pipe (NPT). This outlet may be connected to a suitable discharge line to vent pressure to a safe location in the event of bursting of the rupture disc. Torque required for sealing rupture discs will range from 40 to 90 foot pounds, depending upon pressure and media being used.

Material of body and hold down nut is high tensile 316 stainless steel. Standard tubing glands and collars are provided unless otherwise specified.

Note: Rupture discs are **not** included and must be ordered as a separate item.

| Catalog No. | Tubing | psi | Connections | Orifice | Length | Hex |
|-------------|-----------------------|--------|-------------|---------|-------------------|-------------------|
| 20-61LM4 | $\frac{1}{4}$ " O.D. | 20,000 | LM4 | 0.125" | 2" | 1" |
| 20-61LM6 | $\frac{3}{8}$ " O.D. | 20,000 | LM6 | 0.219" | 2" | 1" |
| 20-61LM9 | $\frac{9}{16}$ " O.D. | 20,000 | LM9 | 0.250" | 2 $\frac{1}{8}$ " | 1" |
| 20-61LM12 | $\frac{3}{4}$ " O.D. | 20,000 | LM12 | 0.250" | 2 $\frac{3}{8}$ " | 1 $\frac{1}{8}$ " |
| 20-61LM16 | 1" O.D. | 20,000 | LM16 | 0.250" | 3 $\frac{1}{2}$ " | 1 $\frac{1}{8}$ " |

Rupture Discs

$\frac{1}{4}$ " Angled Seat

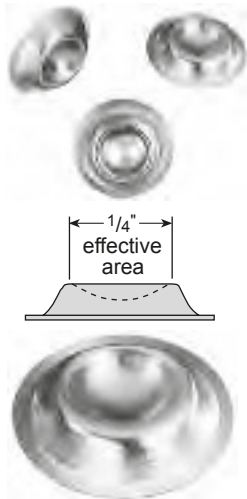

SPECIAL DISCS are available on special order for pressure ranges not shown above and in numerous materials and coatings. Consult factory for price and delivery.

Standard rupture discs are available from stock in burst pressures as listed in the chart below. All pressures through 20,000 psi are shaded. These discs are 316 stainless steel (except for 1,000 psi which are inconel) and may be used with any of the safety heads shown. Note that these rupture discs are supplied with a tolerance of plus 6% and minus 3% of specified burst pressure. Samples of each batch are tested and the actual average burst pressure is stamped on an accompanying metal tag. Factors influencing rupture disc life include corrosion, metal fatigue, and cyclic effects. Periodic replacement is recommended to prevent premature failure.

Standard Burst Pressures (in psi at 72°F)

| | | | | | | | | | |
|-------|-------|-------|-------|--------|--------|--------|--------|--------|--------|
| 1,000 | 3,000 | 5,000 | 7,000 | 9,000 | 11,000 | 17,500 | 25,000 | 37,500 | 55,000 |
| 1,500 | 3,500 | 5,500 | 7,500 | 9,500 | 11,500 | 18,000 | 27,000 | 40,000 | 60,000 |
| 2,000 | 4,000 | 6,000 | 8,000 | 10,000 | 12,500 | 20,000 | 30,000 | 45,000 | 65,000 |
| 2,500 | 4,500 | 6,500 | 8,500 | 10,500 | 15,000 | 22,500 | 35,000 | 50,000 | |



High Pressure Equipment

Anti-Vibration Gland Assemblies

Tubing systems that are subject to extreme vibration or shock, such as mobile pressure systems or long tubing runs culminating at a compressor, will benefit from the use of High Pressure Equipment Company's Anti-Vibration Gland Assemblies. These assemblies utilize the same reliable connection geometries as the standard HiP fittings, with the added benefit of essentially unlimited vibrational fatigue life.

A coned and threaded tube, when subjected to unusual or excessive vibration, may fail prematurely and break at the last thread. The Anti-Vibration Gland Assembly acts to move the fulcrum of vibration away from the threaded portion of the tube and onto the strong, solid wall of the tubing. A wedge-like collet firmly holds the assembly in place, virtually eliminating premature tubing failure while reliably maintaining a leak-free connection between the tube and the connection seat.

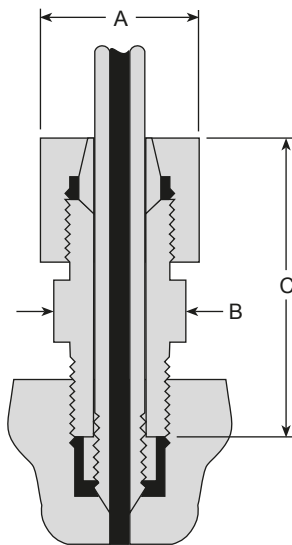

Medium Pressure Anti-Vibration Gland Assemblies

| Catalog No. | Pressure Rating psi | Connections | A | B | C |
|-------------|---------------------|-----------------------|--------|--------|---------|
| 20-3LM4 | 20,000 | 1/4" MEDIUM PRESSURE | 5/8" | 1/2" | 1 7/16" |
| 20-3LM6 | 20,000 | 3/8" MEDIUM PRESSURE | 3/4" | 5/8" | 1 5/8" |
| 20-3LM9 | 20,000 | 9/16" MEDIUM PRESSURE | 1" | 7/8" | 1 7/8" |
| 20-3LM12 | 20,000 | 3/4" MEDIUM PRESSURE | 1 1/4" | 1 1/8" | 2 1/8" |
| 20-3LM16 | 20,000 | 1" MEDIUM PRESSURE | 1 1/2" | 1 3/8" | 2 1/2" |

Anti-Vibration Components

| Tubing Size | Slotted Collet | Collet Gland | Collet Body | Collar |
|-------------|----------------|--------------|-------------|---------|
| 1/4" | 2-8769 | 2-8770 | 2-8768 | 20-2L4 |
| 3/8" | 2-8772 | 2-8773 | 2-8771 | 20-2L6 |
| 9/16" | 2-8775 | 2-8776 | 2-8774 | 20-2L9 |
| 3/4" | 2-8778 | 2-8779 | 2-8777 | 20-2L12 |
| 1" | 2-8781 | 2-8782 | 2-8780 | 20-2L16 |

Medium Pressure Tubing

Tubing is cold drawn, seamless, and is supplied in the $\frac{1}{8}$ hard condition (not annealed). Tensile strength is approximately 40 percent higher than that of annealed tubing. All tubing is manufactured in strict accordance with High Pressure Equipment Company specifications to insure tolerances and bore quality. Tubing is stocked in lengths of 18 to 22 feet but may be ordered in shorter lengths with **no additional cutting charge**.

| | Tubing Size | Working Pressure psi | Type of Connection Used | Material | Catalog Order Number |
|---------------|---------------------------|----------------------|-------------------------------|----------|----------------------|
| 1/4" | 1/4" O.D. x 0.109" I.D. | 20,000 | 1/4" MEDIUM PRESSURE (LF4) | 316 SS | 20-9M4-316 |
| 3/8" | 3/8" O.D. x 0.203" I.D. | 20,000 | 3/8" MEDIUM PRESSURE (LF6) | 316 SS | 20-9M6-316 |
| 9/16" | 9/16" O.D. x 0.359" I.D. | 10,000 | 9/16" MEDIUM PRESSURE (LF9) | 316 SS | 10-9M9-316 |
| | 9/16" O.D. x 0.312" I.D. | 20,000 | | 304 SS | 20-9M9-304 |
| | | | | 316 SS | 20-9M9-316 |
| 3/4" | 3/4" O.D. x 0.516" I.D. | 10,000 | 3/4" MEDIUM PRESSURE (LF12) | 316 SS | 10-9M12-316 |
| | 3/4" O.D. x 0.438" I.D. | 20,000 | | | 20-9M12-316 |
| 1" | 1" O.D. x 0.688" I.D. | 10,000 | 1" MEDIUM PRESSURE (LF16) | 316 SS | 10-9M16-316 |
| | 1" O.D. x 0.562" I.D. | 20,000 | | | 20-9M16-316 |
| 1 1/2" | 1 1/2" O.D. x 0.937" I.D. | 15,000 | 1 1/2" MEDIUM PRESSURE (LF24) | 316 SS | 15-9M24-316 |

Nipples

Nipples are stocked in 316 stainless steel. Nipples in lengths other than those shown are supplied upon request. Nipples are not furnished with collars and glands, unless specified at time of order.

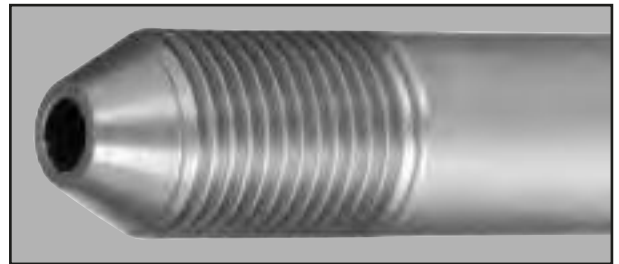

Coned and Threaded Nipples

| Length ↓ | Tubing Size (O.D. x I.D.) | | | | | | | |
|---------------|---------------------------|----------------------------|----------------------------|----------------------------|---------------------------|--------------------------|-------------------------|------------------------------|
| | 1/4" O.D. x 7/64" I.D. | 3/8" O.D. x 13/64" I.D. | 9/16" O.D. x 5/16" I.D. | 3/4" O.D. x 33/64" I.D. | 3/4" O.D. x 7/16" I.D. | 1" O.D. x 11/16" I.D. | 1" O.D. x 9/16" I.D. | 1 1/2" O.D. x 15/16" I.D. |
| psi → | 20,000 psi | 20,000 psi | 20,000 psi | 10,000 psi | 20,000 psi | 10,000 psi | 20,000 psi | 15,000 psi |
| 2 3/4" | 20-LM4-2.75 | | | | | | | |
| 3" | | 20-LM6-3 | | | | | | |
| 4" | | | 20-LM9-4 | 10-LM12-4 | | | | |
| 6" | 20-LM4-6 | 20-LM6-6 | 20-LM9-6 | 10-LM12-6 | 20-LM12-6 | 10-LM16-6 | 20-LM16-6 | 15-LM24-6 |
| 8" | 20-LM4-8 | 20-LM6-8 | 20-LM9-8 | 10-LM12-8 | 20-LM12-8 | 10-LM16-8 | 20-LM16-8 | 15-LM24-8 |
| 10" | 20-LM4-10 | 20-LM6-10 | 20-LM9-10 | 10-LM12-10 | 20-LM12-10 | 10-LM16-10 | 20-LM16-10 | 15-LM24-10 |
| 12" | 20-LM4-12 | 20-LM6-12 | 20-LM9-12 | 10-LM12-12 | 20-LM12-12 | 10-LM16-12 | 20-LM16-12 | 15-LM24-12 |



High Pressure Equipment

Medium Pressure Connections (Coned and Threaded) 20,000 psi service

The Medium Pressure tubing connection is available for 1/4", 3/8", 9/16", 3/4", and 1" O.D. tubing. The tubing may be prepared with the use of tooling (see tooling section 9.0) or prepared at the factory to specified lengths. Additionally, standard length coned and threaded nipples are available from stock (see page 3.9).

This connection has become an industry standard for use at elevated pressures and temperatures in both liquid and gas applications. It may be disassembled and retightened indefinitely. The threads of the gland are right-hand while the threads of the collar and tubing are left-hand to prevent rotation of the collar during assembly.

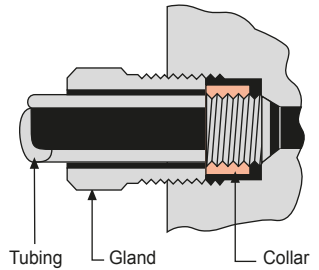

Materials. All of the components required for make-up of a Medium Pressure connection (glands, collars and plugs) are produced in Type 316 stainless steel.

Glands and collars. All valves and fittings are provided (except nipples) unless otherwise requested. (See chart on the right for size details and catalog numbers).

| 20,000 psi | | | | | |
|------------------------------|-------------------------|--------------------------|--------------------------|------------------------|----------------------------|
| LF4 1/4" O.D. Tubing | LF6 3/8" O.D. Tubing | LF9 9/16" O.D. Tubing | LF12 3/4" O.D. Tubing | LF16 1" O.D. Tubing | LF24 1 1/2" O.D. Tubing |
| Female Opening Detail | | | | | |
| | | | | | |
| Gland | | | | | |
| | | | | | |
| Collar | | | | | |
| | | | | | |
| Plug | | | | | |
| | | | | | |
| Tube End Prep | | | | | |
| | | | | | |



High Pressure Equipment

High Pressure Valves, Fittings and Tubing 30,000, 40,000 and 60,000 psi service

High Pressure Equipment Company has developed a line of High Pressure products to assure safe and easy plumbing for 30,000, 40,000 and 60,000 psi. These needle valves, fittings, line filters, check valves, safety heads, rupture discs, anti-vibration gland assemblies, tubing and nipples are engineered to the highest standards of repeatable quality. The reliable performance of these products has made HiP one of the world's leading suppliers of elevated pressure components.

High Pressure components use a coned-and-threaded connection which accommodates the high temperatures and pressures common in these applications. High Pressure valves are available in various tubing sizes and with body designs to satisfy widely varied requirements. A line of fittings is available to facilitate adapting to Taper Seal, Medium Pressure, or other High Pressure threaded pipe systems.



Index

| | Page |
|---------------------------------|-------------|
| 30,000 psi Valves | 4.2-4.3 |
| 40,000 psi Valves | 4.3.5-4.3.6 |
| 60,000 psi Valves | 4.4-4.5 |
| Fittings | 4.6 |
| Unions, Bulkheads & Caps | 4.7 |
| Line Filters & Check Valves | 4.8-4.9 |
| Rupture Discs | 4.9 |
| Safety Heads | 4.10 |
| Anti-Vibration Gland Assemblies | 4.11 |
| Tubing | 4.12 |
| Coned & Threaded Nipples | 4.12 |
| Connection Details | 4.A |
| | Appendix |



High Pressure Equipment

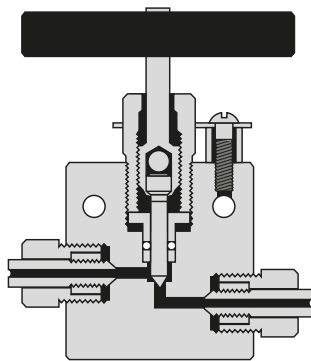

HF2 ($\frac{1}{8}$ ")

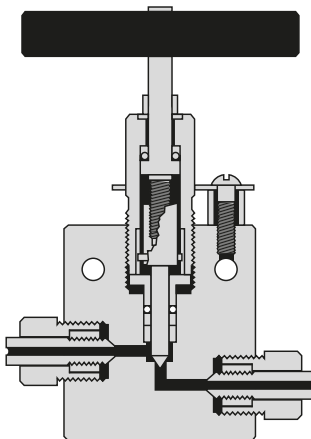

HF4 ($\frac{1}{4}$ "), HF6 ($\frac{3}{8}$ ") and HF9 ($\frac{9}{16}$ ")

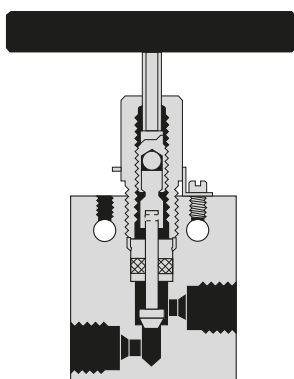

HF16 (1")

30,000 psi High Pressure Valves

High Pressure (coned & threaded) type connections for $\frac{1}{8}$ " , $\frac{1}{4}$ " , $\frac{3}{8}$ " , $\frac{9}{16}$ " and 1" O.D. tubing.

Non-rotating tip stems are standard for on-off service and insure long life on valve seats. Regulating tip stems are available for all valves at no additional cost, add - REG to part number.

Glands and collars for tubing are supplied with each valve unless otherwise requested (glands and collars shown on pages 4.6 and 4.A).

Materials include high tensile type 316 stainless steel bodies and hardened 17-4PH stainless steel lower section stems.

Packing is Teflon (450°F) standard with optional Viton (350°F), BUNA-N (200°F) and Grafoil (800°F) available at no additional cost.

Air operators for remote control operation are available for all valves. (Select required valve and add "HIPCO". Refer to section 7.0 for additional data).

High temperatures can be accommodated using extended stuffing boxes (see page 6.6). These are available for all sizes except $\frac{1}{8}$ " tubing. To order, add suffix -HT to standard valve catalog number.

Valve Features

- Non-rotating stem tips
- Packing below stem threads
- Type 316 ss high tensile bodies
- Positive gland lock device
- No stem adjustment needed
- Black T-handles or choice of 4 colors
- Tube sizes $\frac{1}{8}$ " through $\frac{9}{16}$ "

Two Way Straight Valves

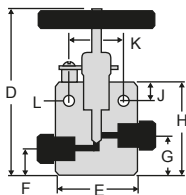

| Tubing | Catalog No. | psi | Connection | Orifice | D | E | F | G | H | J | K | L | Thickness |
|------------|-------------|--------|------------|---------|----------|--------|----------|----------|----------|---------|--------|---------|-----------|
| 1/8" O.D. | 30-11HF2 | 30,000 | HF2 | 1/16" | 3 1/4" | 1 1/2" | 1 1/16" | 15 1/16" | 1 13/16" | 5 1/16" | 7 1/8" | 9 1/64" | 3/4" |
| 1/4" O.D. | 30-11HF4 | 30,000 | HF4 | 3/32" | 5 1/16" | 2" | 5/8" | 1" | 2 7/16" | 1 1/2" | 1 3/8" | 7 1/32" | 1" |
| 3/8" O.D. | 30-11HF6 | 30,000 | HF6 | 1/8" | 5 1/16" | 2" | 5/8" | 1" | 2 7/16" | 1 1/2" | 1 3/8" | 7 1/32" | 1" |
| 9/16" O.D. | 30-11HF9 | 30,000 | HF9 | 1/8" | 5 5/8" | 2 5/8" | 1" | 1 7/16" | 2 7/8" | 1 1/2" | 1 3/8" | 7 1/32" | 1 1/2" |
| 1" O.D. | 30-11HF16 | 30,000 | HF16 | 7/16" | 8 27/64" | 4 1/8" | 1 11/16" | 1 11/16" | 4 7/16" | 1 1/8" | 2 1/2" | 9 1/16" | 1 3/4" |

Two Way Angle Valves

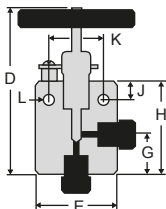

| Tubing | Catalog No. | psi | Connection | Orifice | D | E | F | G | H | J | K | L | Thickness |
|------------|-------------|--------|------------|---------|----------|--------|---|----------|----------|---------|--------|---------|-----------|
| 1/8" O.D. | 30-12HF2 | 30,000 | HF2 | 1/16" | 3 1/4" | 1 1/2" | — | 15 1/16" | 1 13/16" | 5 1/16" | 7 1/8" | 9 1/64" | 3/4" |
| 1/4" O.D. | 30-12HF4 | 30,000 | HF4 | 3/32" | 5 1/16" | 2" | — | 1" | 2 7/16" | 1 1/2" | 1 3/8" | 7 1/32" | 1" |
| 3/8" O.D. | 30-12HF6 | 30,000 | HF6 | 1/8" | 5 1/16" | 2" | — | 1 3/8" | 2 13/16" | 1 1/2" | 1 3/8" | 7 1/32" | 1" |
| 9/16" O.D. | 30-12HF9 | 30,000 | HF9 | 1/8" | 5 5/8" | 2 5/8" | — | 1 7/16" | 2 7/8" | 1 1/2" | 1 3/8" | 7 1/32" | 1 1/2" |
| 1" O.D. | 30-12HF16 | 30,000 | HF16 | 7/16" | 9 11/32" | 4 1/8" | — | 2 3/8" | 5 1/8" | 1 1/8" | 2 1/2" | 9 1/16" | 1 3/4" |

Three Way Valves / Two Pressure Connections

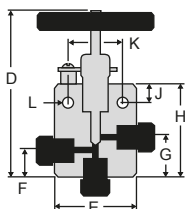

| Tubing | Catalog No. | psi | Connection | Orifice | D | E | F | G | H | J | K | L | Thickness |
|------------|-------------|--------|------------|---------|----------|--------|---------|----------|----------|---------|--------|---------|-----------|
| 1/8" O.D. | 30-13HF2 | 30,000 | HF2 | 1/16" | 3 1/4" | 1 1/2" | 1 1/16" | 15 1/16" | 1 13/16" | 5 1/16" | 7 1/8" | 9 1/64" | 3/4" |
| 1/4" O.D. | 30-13HF4 | 30,000 | HF4 | 3/32" | 5 1/16" | 2" | 5/8" | 1" | 2 7/16" | 1 1/2" | 1 3/8" | 7 1/32" | 1" |
| 3/8" O.D. | 30-13HF6 | 30,000 | HF6 | 1/8" | 5 1/16" | 2" | 1" | 1 3/8" | 2 13/16" | 1 1/2" | 1 3/8" | 7 1/32" | 1" |
| 9/16" O.D. | 30-13HF9 | 30,000 | HF9 | 1/8" | 6 1/16" | 2 5/8" | 1 7/16" | 1 7/8" | 3 5/16" | 1 1/2" | 1 3/8" | 7 1/32" | 1 1/2" |
| 1" O.D. | 30-13HF16 | 30,000 | HF16 | 7/16" | 9 23/32" | 4 1/8" | 2 3/8" | 2 13/16" | 5 9/16" | 1 1/8" | 2 1/2" | 9 1/16" | 1 3/4" |

Three Way Valves / One Pressure Connection

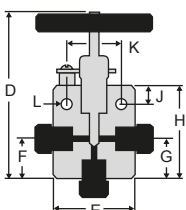

| Tubing | Catalog No. | psi | Connection | Orifice | D | E | F | G | H | J | K | L | Thickness |
|------------|-------------|--------|------------|---------|----------|--------|----------|----------|----------|---------|--------|---------|-----------|
| 1/8" O.D. | 30-14HF2 | 30,000 | HF2 | 1/16" | 3 1/4" | 1 1/2" | 15 1/16" | 15 1/16" | 1 13/16" | 5 1/16" | 7 1/8" | 9 1/64" | 3/4" |
| 1/4" O.D. | 30-14HF4 | 30,000 | HF4 | 3/32" | 5 1/16" | 2" | 1" | 1" | 2 7/16" | 1 1/2" | 1 3/8" | 7 1/32" | 1" |
| 3/8" O.D. | 30-14HF6 | 30,000 | HF6 | 1/8" | 5 1/16" | 2" | 2" | 1 7/16" | 2 13/16" | 1 1/2" | 1 3/8" | 7 1/32" | 1" |
| 9/16" O.D. | 30-14HF9 | 30,000 | HF9 | 1/8" | 5 5/8" | 2 5/8" | 2 3/16" | 1 7/16" | 2 7/8" | 1 1/2" | 1 3/8" | 7 1/32" | 1 1/2" |
| 1" O.D. | 30-14HF16 | 30,000 | HF16 | 7/16" | 9 11/32" | 4 1/8" | 2 3/8" | 2 3/8" | 5 1/8" | 1 1/8" | 2 1/2" | 9 1/16" | 1 3/4" |

Three Way / Two Stem Connection Valves

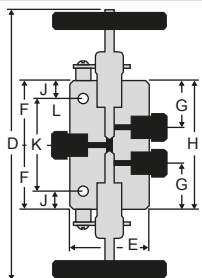

| Tubing | Catalog No. | psi | Connection | Orifice | D | E | F | G | H | J | K | L | Thickness |
|------------|-------------|--------|------------|---------|-----------|--------|----------|---------|--------|---------|--------|---------|-----------|
| 1/8" O.D. | 30-15HF2 | 30,000 | HF2 | 1/16" | 5 1/4" | 1 1/2" | 15 1/16" | 7 1/8" | 2 1/2" | 5 1/16" | 1 7/8" | 9 1/64" | 3/4" |
| 1/4" O.D. | 30-15HF4 | 30,000 | HF4 | 3/32" | 9 1/4" | 2" | 1" | 1 7/16" | 3 3/4" | 1 1/2" | 2 3/4" | 7 1/32" | 1" |
| 3/8" O.D. | 30-15HF6 | 30,000 | HF6 | 1/8" | 9 1/2" | 2" | 2" | 1 7/16" | 4" | 1 1/2" | 3" | 7 1/32" | 1" |
| 9/16" O.D. | 30-15HF9 | 30,000 | HF9 | 1/8" | 9 7/8" | 2 5/8" | 2 3/16" | 1 7/16" | 4 3/8" | 1 1/2" | 3 3/8" | 7 1/32" | 1 1/2" |
| 1" O.D. | 30-15HF16 | 30,000 | HF16 | 7/16" | 11 13/16" | 4 1/8" | 3 7/8" | 2 3/4" | 7 3/4" | 1 1/8" | 2 1/2" | 9 1/16" | 1 3/4" |

Replaceable Seat Valves

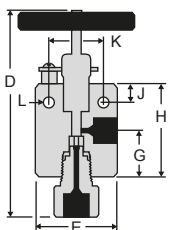

| Tubing | Catalog No. | psi | Connection | Orifice | D | E | F | G | H | J | K | L | Thickness |
|------------|-------------|--------|------------|---------|----------|--------|---|---------|----------|--------|--------|---------|-----------|
| 1/4" O.D. | 30-12HF4-R | 30,000 | HF4 | 3/32" | 6" | 2" | — | 1" | 2 7/16" | 1 1/2" | 1 3/8" | 7 1/32" | 1" |
| 3/8" O.D. | 30-12HF6-R | 30,000 | HF6 | 1/8" | 6 5/8" | 2" | — | 1 3/8" | 2 13/16" | 1 1/2" | 1 3/8" | 7 1/32" | 1" |
| 9/16" O.D. | 30-12HF9-R | 30,000 | HF9 | 1/8" | 6 13/16" | 2 5/8" | — | 1 7/16" | 2 7/8" | 1 1/2" | 1 3/8" | 7 1/32" | 1 1/2" |
| 1" O.D. | 30-12HF16-R | 30,000 | HF16 | 7/16" | 10 7/8" | 4 1/8" | — | 2 3/8" | 5 1/8" | 1 1/8" | 2 1/2" | 9 1/16" | 1 3/4" |



High Pressure Equipment

40,000 psi High Pressure Valves

High Pressure (coned & threaded) type connections for $\frac{9}{16}$ " O.D. tubing.

Non-rotating tip stems are standard for on-off service and insure long life on valve seats. Regulating tip stems are available for all valves at no additional cost, add - REG to part number.

Glands and collars for tubing are supplied with each valve unless otherwise requested (glands and collars shown on pages 4.6 and 4.A).

Materials include high tensile type 316 stainless steel bodies and hardened 17-4PH stainless steel lower section stems.

Packing set consists of multiple Teflon packing with nylon back up, with optional Viton (350°F), BUNA-N (200°F) and Grafoil (800°F) available at no additional cost.

Air operators for remote control operation are available for all valves. (Select required valve and add "HIPCO". Refer to section 7.0 for additional data).

High temperatures can be accommodated using extended stuffing boxes (see page 6.6).

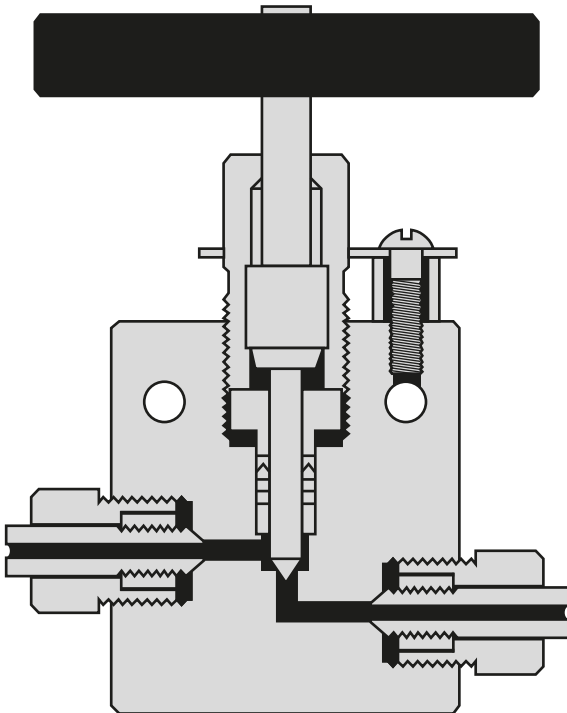

Valve Features

- Non-rotating stem tips
- Packing below stem threads
- Type 316 ss high tensile bodies
- Positive gland lock device
- No stem adjustment needed
- Black T-handles or choice of 4 colors

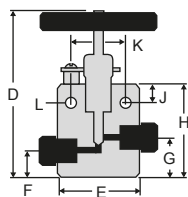

Two Way Straight Valves

| Tubing | Catalog No. | psi | Connection | Orifice | D | E | F | G | H | J | K | L | Thickness |
|------------|-------------|--------|------------|---------|--------|--------|----|---------|--------|------|--------|-------|-----------|
| 9/16" O.D. | 40-11HF9 | 40,000 | HF9 | 1/8" | 5 5/8" | 2 5/8" | 1" | 1 7/16" | 2 7/8" | 1/2" | 1 5/8" | 7/32" | 1 1/2" |

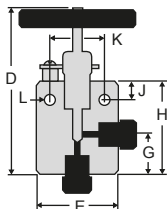

Two Way Angle Valves

| Tubing | Catalog No. | psi | Connection | Orifice | D | E | F | G | H | J | K | L | Thickness |
|------------|-------------|--------|------------|---------|--------|--------|---|---------|--------|------|--------|-------|-----------|
| 9/16" O.D. | 40-12HF9 | 40,000 | HF9 | 1/8" | 5 5/8" | 2 5/8" | — | 1 7/16" | 2 7/8" | 1/2" | 1 5/8" | 7/32" | 1 1/2" |

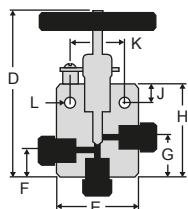

Three Way Valves / Two Pressure Connections

| Tubing | Catalog No. | psi | Connection | Orifice | D | E | F | G | H | J | K | L | Thickness |
|------------|-------------|--------|------------|---------|---------|--------|---------|--------|---------|------|--------|-------|-----------|
| 9/16" O.D. | 40-13HF9 | 40,000 | HF9 | 1/8" | 6 1/16" | 2 5/8" | 1 7/16" | 1 7/8" | 3 5/16" | 1/2" | 1 5/8" | 7/32" | 1 1/2" |

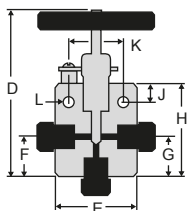

Three Way Valves / One Pressure Connection

| Tubing | Catalog No. | psi | Connection | Orifice | D | E | F | G | H | J | K | L | Thickness |
|------------|-------------|--------|------------|---------|--------|--------|---------|---------|--------|------|--------|-------|-----------|
| 9/16" O.D. | 40-14HF9 | 40,000 | HF9 | 1/8" | 5 5/8" | 2 5/8" | 1 7/16" | 1 7/16" | 2 7/8" | 1/2" | 1 5/8" | 7/32" | 1 1/2" |

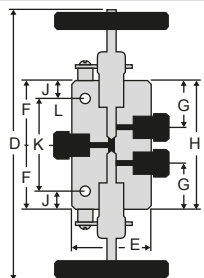

Three Way / Two Stem Connection Valves

| Tubing | Catalog No. | psi | Connection | Orifice | D | E | F | G | H | J | K | L | Thickness |
|------------|-------------|--------|------------|---------|--------|--------|---------|---------|--------|------|--------|-------|-----------|
| 9/16" O.D. | 40-15HF9 | 40,000 | HF9 | 1/8" | 9 7/8" | 2 5/8" | 2 3/16" | 1 7/16" | 4 3/8" | 1/2" | 3 3/8" | 7/32" | 1 1/2" |

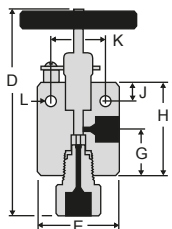

Replaceable Seat Valves

| Tubing | Catalog No. | psi | Connection | Orifice | D | E | F | G | H | J | K | L | Thickness |
|------------|-------------|--------|------------|---------|--------|--------|---|---------|--------|------|--------|-------|-----------|
| 9/16" O.D. | 40-12HF9-R | 40,000 | HF9 | 1/8" | 6 3/8" | 2 5/8" | — | 1 7/16" | 2 7/8" | 1/2" | 1 5/8" | 7/32" | 1 1/2" |



High Pressure Equipment

60,000 psi High Pressure Valves

High Pressure (coned & threaded) type connections for $\frac{1}{8}$ ", $\frac{1}{4}$ ", $\frac{3}{8}$ ", $\frac{9}{16}$ " and 1" O.D. tubing.

Non-rotating tip stems are standard for on-off service and insure long life on valve seats. Regulating tip stems are available for all valves at no additional cost, add - REG to part number.

Glands and collars for tubing are supplied with each valve unless otherwise requested (glands and collars shown on pages 4.6 and 4.A).

Materials include high tensile type 316 stainless steel bodies and hardened 17-4PH stainless steel lower section stems.

Packing set consists of multiple Teflon packing with nylon back up, with optional Viton (350°F), BUNA-N (200°F) and Grafoil (800°F) available at no additional cost.

Air operators for remote control operation are available for all valves. (Select required valve and add "HIPCO". Refer to section 7.0 for additional data).

High temperatures can be accommodated using extended stuffing boxes (see page 6.6). These are available for all sizes except $\frac{1}{8}$ " tubing.

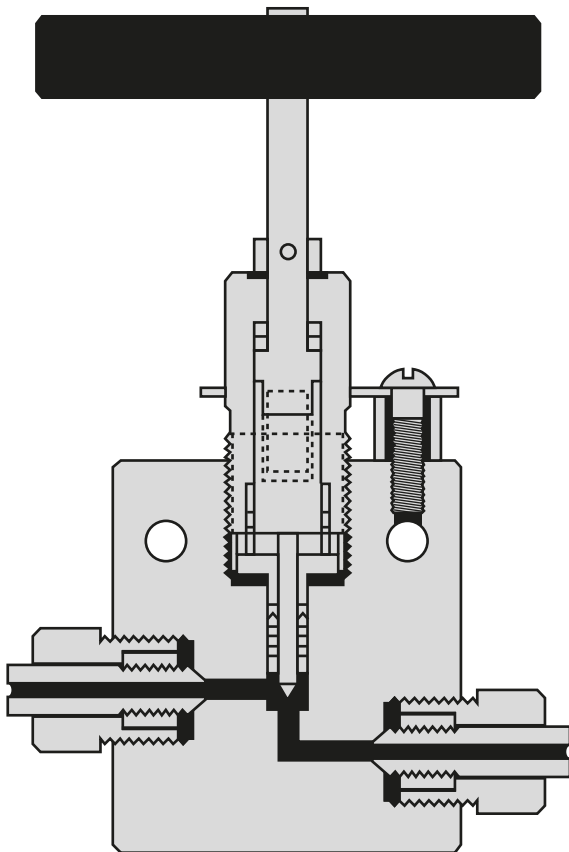

Valve Features

- Non-rotating stem tips
- Packing below stem threads
- Type 316 ss high tensile bodies
- Positive gland lock device
- No stem adjustment needed
- Black T-handles or choice of 4 colors
- Tube sizes $\frac{1}{8}$ " through $\frac{9}{16}$ "

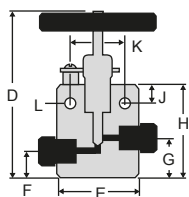

Two Way Straight Valves

| Tubing | Catalog No. | psi | Connection | Orifice | D | E | F | G | H | J | K | L | Thickness |
|------------|-------------|--------|------------|---------|---------|--------|------|---------|---------|------|--------|-------|-----------|
| 1/8" O.D. | 60-11HF2 | 60,000 | HF2 | 1/16" | 5 3/16" | 2" | 5/8" | 1 5/16" | 2 7/16" | 1/2" | 1 3/8" | 7/32" | 1" |
| 1/4" O.D. | 60-11HF4 | 60,000 | HF4 | 1/16" | 5 3/16" | 2" | 5/8" | 1" | 2 7/16" | 1/2" | 1 3/8" | 7/32" | 1" |
| 3/8" O.D. | 60-11HF6 | 60,000 | HF6 | 1/16" | 5 3/16" | 2" | 5/8" | 1" | 2 7/16" | 1/2" | 1 3/8" | 7/32" | 1" |
| 9/16" O.D. | 60-11HF9 | 60,000 | HF9 | 1/16" | 5 5/8" | 2 5/8" | 1" | 1 7/16" | 2 7/8" | 1/2" | 1 3/8" | 7/32" | 1 1/2" |

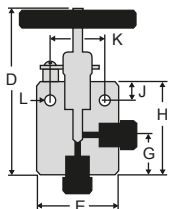

Two Way Angle Valves

| Tubing | Catalog No. | psi | Connection | Orifice | D | E | F | G | H | J | K | L | Thickness |
|------------|-------------|--------|------------|---------|---------|--------|---|---------|----------|------|--------|-------|-----------|
| 1/8" O.D. | 60-12HF2 | 60,000 | HF2 | 1/16" | 5 3/16" | 2" | — | 1" | 2 7/16" | 1/2" | 1 3/8" | 7/32" | 1" |
| 1/4" O.D. | 60-12HF4 | 60,000 | HF4 | 1/16" | 5 3/16" | 2" | — | 1" | 2 7/16" | 1/2" | 1 3/8" | 7/32" | 1" |
| 3/8" O.D. | 60-12HF6 | 60,000 | HF6 | 1/16" | 5 3/16" | 2" | — | 1 3/8" | 2 13/16" | 1/2" | 1 3/8" | 7/32" | 1" |
| 9/16" O.D. | 60-12HF9 | 60,000 | HF9 | 1/16" | 5 5/8" | 2 5/8" | — | 1 7/16" | 2 7/8" | 1/2" | 1 3/8" | 7/32" | 1 1/2" |

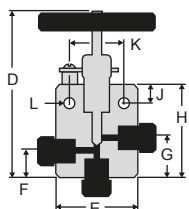

Three Way Valves / Two Pressure Connections

| Tubing | Catalog No. | psi | Connection | Orifice | D | E | F | G | H | J | K | L | Thickness |
|------------|-------------|--------|------------|---------|---------|--------|---------|--------|----------|------|--------|-------|-----------|
| 1/8" O.D. | 60-13HF2 | 60,000 | HF2 | 1/16" | 5 3/16" | 2" | 5/8" | 1" | 2 7/16" | 1/2" | 1 3/8" | 7/32" | 1" |
| 1/4" O.D. | 60-13HF4 | 60,000 | HF4 | 1/16" | 5 3/16" | 2" | 5/8" | 1" | 2 7/16" | 1/2" | 1 3/8" | 7/32" | 1" |
| 3/8" O.D. | 60-13HF6 | 60,000 | HF6 | 1/16" | 5 3/16" | 2" | 1" | 1 3/8" | 2 13/16" | 1/2" | 1 3/8" | 7/32" | 1" |
| 9/16" O.D. | 60-13HF9 | 60,000 | HF9 | 1/16" | 6 1/16" | 2 5/8" | 1 7/16" | 1 7/8" | 3 5/16" | 1/2" | 1 3/8" | 7/32" | 1 1/2" |

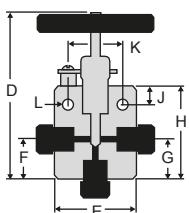

Three Way Valves / One Pressure Connection

| Tubing | Catalog No. | psi | Connection | Orifice | D | E | F | G | H | J | K | L | Thickness |
|------------|-------------|--------|------------|---------|---------|--------|---------|---------|----------|------|--------|-------|-----------|
| 1/8" O.D. | 60-14HF2 | 60,000 | HF2 | 1/16" | 5 3/16" | 2" | 7/8" | 1/2" | 2 7/16" | 1/2" | 1 3/8" | 7/32" | 1" |
| 1/4" O.D. | 60-14HF4 | 60,000 | HF4 | 1/16" | 5 3/16" | 2" | 1" | 1" | 2 7/16" | 1/2" | 1 3/8" | 7/32" | 1" |
| 3/8" O.D. | 60-14HF6 | 60,000 | HF6 | 1/16" | 5 3/16" | 2" | 1 3/8" | 1 3/8" | 2 13/16" | 1/2" | 1 3/8" | 7/32" | 1" |
| 9/16" O.D. | 60-14HF9 | 60,000 | HF9 | 1/16" | 5 5/8" | 2 5/8" | 1 7/16" | 1 7/16" | 2 7/8" | 1/2" | 1 3/8" | 7/32" | 1 1/2" |

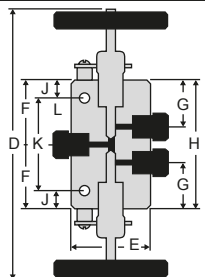

Three Way / Two Stem Connection Valves

| Tubing | Catalog No. | psi | Connection | Orifice | D | E | F | G | H | J | K | L | Thickness |
|------------|-------------|--------|------------|---------|--------|--------|---------|---------|--------|------|--------|-------|-----------|
| 1/8" O.D. | 60-15HF2 | 60,000 | HF2 | 1/16" | 9 1/4" | 2" | 1 7/8" | 1 7/16" | 3 3/4" | 1/2" | 2 3/4" | 7/32" | 1" |
| 1/4" O.D. | 60-15HF4 | 60,000 | HF4 | 1/16" | 9 1/4" | 2" | 1 7/8" | 1 7/16" | 3 3/4" | 1/2" | 2 3/4" | 7/32" | 1" |
| 3/8" O.D. | 60-15HF6 | 60,000 | HF6 | 1/16" | 9 1/2" | 2" | 2" | 1 7/16" | 4" | 1/2" | 3" | 7/32" | 1" |
| 9/16" O.D. | 60-15HF9 | 60,000 | HF9 | 1/16" | 9 7/8" | 2 5/8" | 2 3/16" | 1 7/16" | 4 3/8" | 1/2" | 3 3/8" | 7/32" | 1 1/2" |

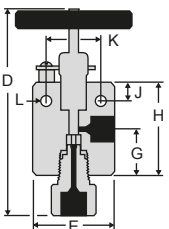

Replaceable Seat Valves

| Tubing | Catalog No. | psi | Connection | Orifice | D | E | F | G | H | J | K | L | Thickness |
|------------|-------------|--------|------------|---------|----------|--------|---|---------|----------|------|--------|-------|-----------|
| 1/4" O.D. | 60-12HF4-R | 60,000 | HF4 | 1/16" | 6" | 2" | — | 1" | 2 7/16" | 1/2" | 1 3/8" | 7/32" | 1" |
| 3/8" O.D. | 60-12HF6-R | 60,000 | HF6 | 1/16" | 6 5/8" | 2" | — | 1 3/8" | 2 13/16" | 1/2" | 1 3/8" | 7/32" | 1" |
| 9/16" O.D. | 60-12HF9-R | 60,000 | HF9 | 1/16" | 6 13/16" | 2 5/8" | — | 1 7/16" | 2 7/8" | 1/2" | 1 3/8" | 7/32" | 1 1/2" |



High Pressure Equipment

Glands/Sleeves/Plugs/Elbows/Tees/Crosses

A complete range of elbows, tees, and crosses is available for all of the tubing connection sizes. Material is high tensile 316 stainless steel. Standard tubing glands and collars are provided unless otherwise specified.

Connection Components

| Catalog No. | Tube Size | Gland | Catalog No. | Tube Size | Collar | Catalog No. | Tube Size | Plug |
|-------------|-----------|-------|-------------|-----------|--------|-------------|-----------|------|
| 60-2HM2 | 1/8" | | 60-2H2 | 1/8" | | 60-7HM2 | 1/8" | |
| 60-2HM4 | 1/4" | | 60-2H4 | 1/4" | | 60-7HM4 | 1/4" | |
| 60-2HM6 | 3/8" | | 60-2H6 | 3/8" | | 60-7HM6 | 3/8" | |
| 60-2HM9 | 9/16" | | 60-2H9 | 9/16" | | 60-7HM9 | 9/16" | |
| 40-2HM9 | 9/16" | | 40-2H9 | 9/16" | | 40-7HM9 | 9/16" | |
| 30-2HM16 | 1" | | 30-2H16 | 1" | | 30-7HM16 | 1" | |

High Pressure Elbows

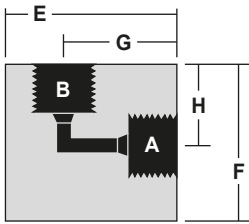

| Catalog No. | Pressure Rating psi | Connections | A-B | E | F | G | H | Thickness |
|-------------|---------------------|-----------------|------|--------|--------|---------|---------|-----------|
| 60-22HF2 | 60,000 | 1/8" O.D. TUBE | HF2 | 1 1/8" | 1 1/8" | 3/4" | 3/4" | 3/4" |
| 60-22HF4 | 60,000 | 1/4" O.D. TUBE | HF4 | 1 3/8" | 1 1/2" | 7/8" | 1" | 1" |
| 60-22HF6 | 60,000 | 3/8" O.D. TUBE | HF6 | 1 3/4" | 1 1/2" | 1 1/4" | 1" | 1" |
| 60-22HF9 | 60,000 | 9/16" O.D. TUBE | HF9 | 2 5/8" | 1 7/8" | 1 7/8" | 1 1/8" | 1 1/2" |
| 40-22HF9 | 40,000 | 9/16" O.D. TUBE | HF9 | 2 5/8" | 1 7/8" | 1 7/8" | 1 1/8" | 1 1/2" |
| 30-22HF16 | 30,000 | 1" O.D. TUBE | HF16 | 3" | 3" | 2 1/16" | 2 1/16" | 1 3/4" |

High Pressure Tees

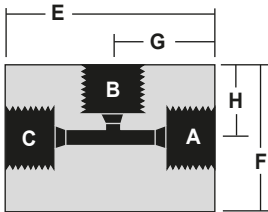

| Catalog No. | Pressure Rating psi | Connections | A-B-C | E | F | G | H | Thickness |
|-------------|---------------------|-----------------|-------|--------|---------|---------|---------|-----------|
| 60-23HF2 | 60,000 | 1/8" O.D. TUBE | HF2 | 1 1/2" | 1 1/8" | 3/4" | 3/4" | 3/4" |
| 60-23HF4 | 60,000 | 1/4" O.D. TUBE | HF4 | 2" | 1 3/8" | 1" | 7/8" | 1" |
| 60-23HF6 | 60,000 | 3/8" O.D. TUBE | HF6 | 2" | 1 9/16" | 1" | 1 1/16" | 1" |
| 60-23HF9 | 60,000 | 9/16" O.D. TUBE | HF9 | 2 5/8" | 2 1/8" | 1 5/16" | 1 3/8" | 1 1/2" |
| 40-23HF9 | 40,000 | 9/16" O.D. TUBE | HF9 | 2 5/8" | 2 1/8" | 1 5/16" | 1 3/8" | 1 1/2" |
| 30-23HF16 | 30,000 | 1" O.D. TUBE | HF16 | 4 1/8" | 3" | 2 1/16" | 2 1/16" | 1 3/4" |

High Pressure Crosses

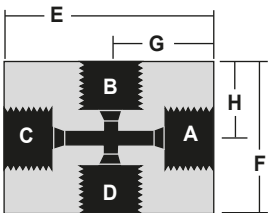

| Catalog No. | Pressure Rating psi | Connections | A-B-C-D | E | F | G | H | Thickness |
|-------------|---------------------|-----------------|---------|--------|--------|---------|---------|-----------|
| 60-24HF2 | 60,000 | 1/8" O.D. TUBE | HF2 | 1 1/2" | 1 1/2" | 3/4" | 3/4" | 3/4" |
| 60-24HF4 | 60,000 | 1/4" O.D. TUBE | HF4 | 2" | 1 1/2" | 1" | 3/4" | 1" |
| 60-24HF6 | 60,000 | 3/8" O.D. TUBE | HF6 | 2 1/8" | 2" | 1 1/16" | 1" | 1" |
| 60-24HF9 | 60,000 | 9/16" O.D. TUBE | HF9 | 2 3/4" | 2 5/8" | 1 3/8" | 1 5/16" | 1 1/2" |
| 40-24HF9 | 40,000 | 9/16" O.D. TUBE | HF9 | 2 3/4" | 2 5/8" | 1 3/8" | 1 5/16" | 1 1/2" |
| 30-24HF16 | 30,000 | 1" O.D. TUBE | HF16 | 4 1/8" | 4 1/8" | 2 1/16" | 2 1/16" | 1 3/4" |

Union Couplings (Slip Type)

Union (slip type) couplings are ideal for use in confined space installations. This design allows the entire coupling to be disconnected and slipped back over the tubing to facilitate assembly and disassembly. In installations where tubing is easily assembled, it is preferable (and less expensive) to use standard straight couplings (see accessories section). Standard material is high tensile 316 stainless steel. Standard tubing collars and glands are provided unless otherwise specified.

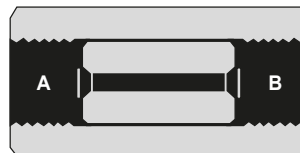

| Catalog No. | Pressure Rating psi | Connections | A | B | Length | Hex Size |
|-------------|---------------------|-------------------|------|------|--------|----------|
| 60-21HF2-U | 60,000 | 1/8" O.D. TUBING | HF2 | HF2 | 1 1/8" | 3/4" |
| 60-21HF4-U | 60,000 | 1/4" O.D. TUBING | HF4 | HF4 | 1 3/4" | 1" |
| 60-21HF6-U | 60,000 | 3/8" O.D. TUBING | HF6 | HF6 | 2" | 1" |
| 60-21HF9-U | 60,000 | 9/16" O.D. TUBING | HF9 | HF9 | 2 3/8" | 1 3/8" |
| 40-21HF9-U | 40,000 | 9/16" O.D. TUBING | HF9 | HF9 | 2 3/8" | 1 3/8" |
| 30-21HF16-U | 30,000 | 1" O.D. TUBING | HF16 | HF16 | 3 1/2" | 1 3/4" |

Bulkhead Couplings

Bulkhead couplings are designed specifically for passing a tubing connection through a panel or steel barricade. These couplings include a locknut as shown. Material is high tensile 316 stainless steel. Standard tubing collars and glands are included unless otherwise specified.

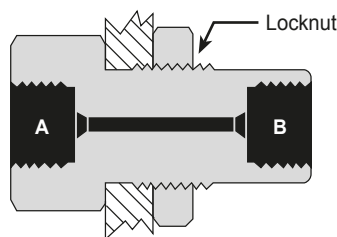

| Catalog No. | Pressure Rating psi | Connections | Panel Hole | A | B | Length | Hex Size | Outside Thread |
|-------------|---------------------|-------------------|------------|------|------|----------|----------|----------------|
| 60-21HF2-B | 60,000 | 1/8" O.D. TUBING | 15/16" | HF2 | HF2 | 1 13/16" | 1" | 7/8" - 14 |
| 60-21HF4-B | 60,000 | 1/4" O.D. TUBING | 15/16" | HF4 | HF4 | 2" | 1" | 7/8" - 14 |
| 60-21HF6-B | 60,000 | 3/8" O.D. TUBING | 1 1/8" | HF6 | HF6 | 2 3/8" | 1 3/8" | 1 1/8" - 12 |
| 60-21HF9-B | 60,000 | 9/16" O.D. TUBING | 1 11/16" | HF9 | HF9 | 2 3/4" | 1 7/8" | 1 5/8" - 12 |
| 40-21HF9-B | 40,000 | 9/16" O.D. TUBING | 1 11/16" | HF9 | HF9 | 2 3/4" | 1 7/8" | 1 5/8" - 12 |
| 30-21HF16-B | 30,000 | 1" O.D. TUBING | 1 15/16" | HF16 | HF16 | 3 1/2" | 2 1/8" | 2 1/8" - 12 |

Caps

Tubing end caps are offered for use in sealing off tubing ends either for temporary use or permanent use such as on small volume reservoirs. Standard material is high tensile 316 stainless steel. Standard tubing collars and glands are provided unless otherwise specified.

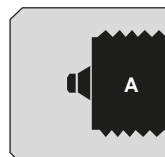

| Catalog No. | Pressure Rating psi | Connections | A | Length | Hex Size |
|-------------|---------------------|-------------------|------|--------|----------|
| 60-21HF2-C | 60,000 | 1/8" O.D. TUBING | HF2 | 7/8" | 3/4" |
| 60-21HF4-C | 60,000 | 1/4" O.D. TUBING | HF4 | 7/8" | 3/4" |
| 60-21HF6-C | 60,000 | 3/8" O.D. TUBING | HF6 | 1 1/4" | 1" |
| 60-21HF9-C | 60,000 | 9/16" O.D. TUBING | HF9 | 1 1/2" | 1 3/8" |
| 40-21HF9-C | 40,000 | 9/16" O.D. TUBING | HF9 | 1 1/2" | 1 3/8" |
| 30-21HF16-C | 30,000 | 1" O.D. TUBING | HF16 | 3" | 1 3/4" |



High Pressure Equipment

Line Filters

The line filters as shown utilize sintered stainless steel filter discs 3 pc./set. Porosities are available as per the chart to the right. If not otherwise specified, 100 micron filter discs are supplied. (One micron = 0.001 millimeters). Material of bodies and end covers is high tensile 316 stainless steel. Standard tubing glands and collars are provided unless otherwise specified.

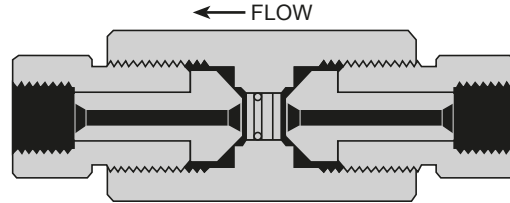

| Catalog No. | Pressure Rating psi | Connections | Length | Hex Size | Micron Size Filter Available | | | | | |
|-------------|---------------------|---------------------|----------|----------|------------------------------|---|---|----|----|-----|
| | | | | | 0.5 | 2 | 5 | 10 | 40 | 100 |
| 40F-51HF9 | 40,000 | 9/16" HIGH PRESSURE | 5 3/4" | 1 1/2" | • | • | • | • | • | • |
| 60F-51HF2 | 60,000 | 1/8" HIGH PRESSURE | 4 11/16" | 1 1/2" | • | • | • | • | • | • |
| 60F-51HF4 | 60,000 | 1/4" HIGH PRESSURE | 4 7/8" | 1 1/2" | • | • | • | • | • | • |
| 60F-51HF6 | 60,000 | 3/8" HIGH PRESSURE | 5 1/4" | 1 1/2" | • | • | • | • | • | • |
| 60F-51HF9 | 60,000 | 9/16" HIGH PRESSURE | 5 3/4" | 1 1/2" | • | • | • | • | • | • |

Ball Check Valves

Ball type check valves insure flow in one direction only. Material for bodies and covers is 316 stainless steel (30-41HF16 body and cover are 17-4PH). Standard tubing glands and collars are provided unless otherwise specified.

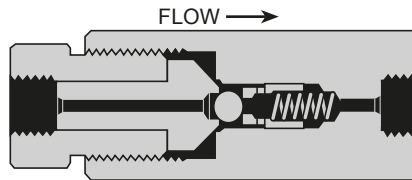

| Catalog No. | psi | Connections | Length | Hex |
|-------------|--------|---------------------|---------|----------------------|
| 40-41HF9 | 40,000 | 9/16" HIGH PRESSURE | 5 1/8" | 1 1/2" |
| 60-41HF2 | 60,000 | 1/8" HIGH PRESSURE | 4 3/16" | 1 1/2" |
| 60-41HF4 | 60,000 | 1/4" HIGH PRESSURE | 4 1/4" | 1 1/2" |
| 60-41HF6 | 60,000 | 3/8" HIGH PRESSURE | 4 5/8" | 1 1/2" |
| 60-41HF9 | 60,000 | 9/16" HIGH PRESSURE | 5 1/8" | 1 1/2" |
| 30-41HF16 | 30,000 | 1" HIGH PRESSURE | 6 1/2" | 2 1/2" RD with flats |

Soft Seat Check Valves

Soft seat check valves insure flow in one direction only and can be mounted in any position. These are highly reliable for both gas and liquid service. Standard O-ring (soft seat) material for the sealing surface is Buna-N (nitrile) with other materials including Teflon and Viton available on request. Temperature is limited by the choice of O-ring material. Material of all other parts is high tensile 316 stainless steel. (30-41HF16-T body and cover are 17-4PH). Standard glands and collars are provided unless otherwise specified.

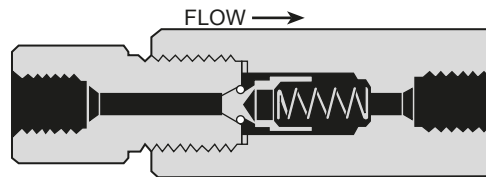

| Catalog No. | psi | Connections | Length | Hex |
|-------------|--------|---------------------|---------|----------------------|
| 30-41HF2-T | 30,000 | 1/8" HIGH PRESSURE | 3 3/4" | 1" |
| 30-41HF4-T | 30,000 | 1/4" HIGH PRESSURE | 3 7/8" | 1" |
| 30-41HF6-T | 30,000 | 3/8" HIGH PRESSURE | 3 7/8" | 1" |
| 30-41HF9-T | 30,000 | 9/16" HIGH PRESSURE | 4 1/4" | 1 3/8" |
| 40-41HF9-T | 40,000 | 9/16" HIGH PRESSURE | 5 1/16" | 1 1/2" |
| 60-41HF4-T | 60,000 | 1/4" HIGH PRESSURE | 4 9/16" | 1 1/2" |
| 60-41HF6-T | 60,000 | 3/8" HIGH PRESSURE | 4 9/16" | 1 1/2" |
| 60-41HF9-T | 60,000 | 9/16" HIGH PRESSURE | 5 1/16" | 1 1/2" |
| 30-41HF16-T | 30,000 | 1" HIGH PRESSURE | 6 1/2" | 2 1/2" RD with flats |

Excess Surge Check Valves

Excess surge check valves are used to eliminate loss of pressure due to a sudden surge or opening of a pressure component in a pressurized system (such as a breakage of a gauge or test component). These check valves should be mounted in the vertical position. Only one basic size is available (60-41HF9-E) with adapters readily available to convert to other size connections. Standard tubing glands and collars are provided unless otherwise specified.

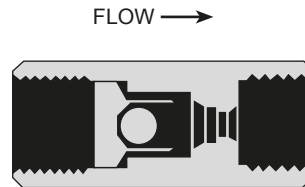

| Catalog No. | psi | Connections | Length | Hex |
|-------------|--------|--------------------------------|-------------------|-------------------|
| 60-41HF9-E | 60,000 | $\frac{9}{16}$ " HIGH PRESSURE | 3 $\frac{1}{8}$ " | 1 $\frac{1}{2}$ " |

Rupture Discs

$\frac{1}{4}$ " Angled Seat

Standard rupture discs are available from stock in burst pressures as listed in the chart to the right. These discs are 316 stainless steel (except for 1000 psi which are inconel) and may be used with any of the safety heads shown. Note that these rupture discs are manufactured with a tolerance of plus 6% and minus 3% of specified burst pressure. Samples of each batch are then tested and the actual average burst pressure is stamped on the accompanying metal tag. Factors influencing rupture disc life include corrosion, metal fatigue, and cyclic effect. Periodic replacement is recommended to prevent premature failure. It is recommended that working pressure does not exceed 70% of burst rating for maximum life cycle of the disc.

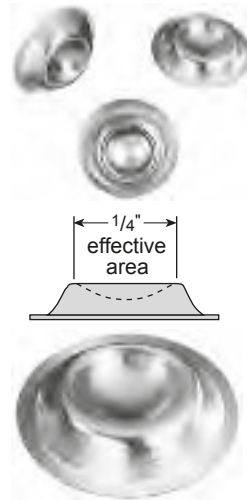

SPECIAL DISCS are available on special order for pressure ranges not shown above and in numerous materials and coatings. Consult factory for price and delivery.

Standard Burst Pressures (in psi at 72°F)

| | | | | | | | | | |
|-------|-------|-------|-------|--------|--------|--------|--------|--------|--------|
| 1,000 | 3,000 | 5,000 | 7,000 | 9,000 | 11,000 | 17,500 | 25,000 | 37,500 | 55,000 |
| 1,500 | 3,500 | 5,500 | 7,500 | 9,500 | 11,500 | 18,000 | 27,000 | 40,000 | 60,000 |
| 2,000 | 4,000 | 6,000 | 8,000 | 10,000 | 12,500 | 20,000 | 30,000 | 45,000 | 65,000 |
| 2,500 | 4,500 | 6,500 | 8,500 | 10,500 | 15,000 | 22,500 | 35,000 | 50,000 | |



High Pressure Equipment

Safety Heads

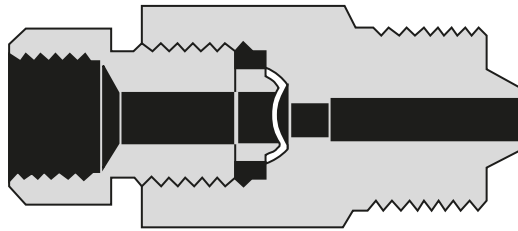

A choice of three safety head designs is available, male inlet, female inlet (straight), and tee type. The male inlet design can be inserted directly into the tubing connections of valves and various fittings such as tees and crosses, or located in pressure vessels.

Outlet connections on all sizes are $\frac{3}{8}$ " pipe (NPT). This outlet may be connected to a suitable discharge line to vent pressure to a safe location in the event of bursting of the rupture disc. Torque required for sealing rupture discs will range from 40 to 90 foot pounds, depending upon pressure and media being used.

Material of bodies and hold down nuts is high tensile 316 stainless steel. Standard tubing glands and collars are provided unless otherwise specified.

Note: Rupture discs are **not** included and must be ordered as a separate item.



Male Inlet Safety Heads

| Catalog No. | Pressure Rating psi | Inlet Connection | Length | Hex Size |
|-------------|---------------------|--------------------------------|------------------|------------------|
| 60-61HM4 | 60,000 | $\frac{1}{4}$ " HIGH PRESSURE | $1\frac{7}{8}$ " | $1\frac{1}{8}$ " |
| 60-61HM6 | 60,000 | $\frac{3}{8}$ " HIGH PRESSURE | $2\frac{1}{8}$ " | $1\frac{1}{8}$ " |
| 60-61HM9 | 60,000 | $\frac{9}{16}$ " HIGH PRESSURE | $2\frac{3}{8}$ " | $1\frac{1}{2}$ " |
| 40-61HM9 | 40,000 | $\frac{9}{16}$ " HIGH PRESSURE | $2\frac{3}{8}$ " | $1\frac{1}{2}$ " |
| 30-61HM16 | 30,000 | 1" HIGH PRESSURE | $3\frac{1}{2}$ " | $1\frac{1}{8}$ " |

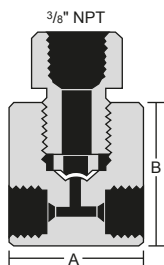

Tee Type Safety Heads

| Catalog No. | Pressure Rating psi | Inlet Connection | A | B | Thickness |
|-------------|---------------------|--------------------------------|------------------|------------------|------------------|
| 60-63HF2 | 60,000 | $\frac{1}{8}$ " HIGH PRESSURE | $1\frac{1}{2}$ " | $1\frac{3}{4}$ " | 1" |
| 60-63HF4 | 60,000 | $\frac{1}{4}$ " HIGH PRESSURE | $1\frac{1}{2}$ " | $1\frac{3}{4}$ " | 1" |
| 60-63HF6 | 60,000 | $\frac{3}{8}$ " HIGH PRESSURE | 2" | $1\frac{3}{4}$ " | 1" |
| 60-63HF9 | 60,000 | $\frac{9}{16}$ " HIGH PRESSURE | $2\frac{5}{8}$ " | 2" | $1\frac{1}{2}$ " |
| 40-63HF9 | 40,000 | $\frac{9}{16}$ " HIGH PRESSURE | 2" | $2\frac{5}{8}$ " | $1\frac{1}{2}$ " |

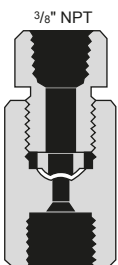

Female Inlet (Straight) Safety Heads

| Catalog No. | Pressure Rating psi | Inlet Connection | Length | Hex Size |
|-------------|---------------------|--------------------------------|------------------|------------------|
| 60-61HF2 | 60,000 | $\frac{1}{8}$ " HIGH PRESSURE | $1\frac{7}{8}$ " | $1\frac{1}{8}$ " |
| 60-61HF4 | 60,000 | $\frac{1}{4}$ " HIGH PRESSURE | $1\frac{7}{8}$ " | $1\frac{1}{8}$ " |
| 60-61HF6 | 60,000 | $\frac{3}{8}$ " HIGH PRESSURE | $1\frac{7}{8}$ " | $1\frac{1}{8}$ " |
| 60-61HF9 | 60,000 | $\frac{9}{16}$ " HIGH PRESSURE | $2\frac{1}{8}$ " | $1\frac{1}{2}$ " |
| 40-61HF9 | 40,000 | $\frac{9}{16}$ " HIGH PRESSURE | $2\frac{3}{8}$ " | $1\frac{1}{2}$ " |

Anti-Vibration Gland Assemblies

Tubing systems that are subject to extreme vibration or shock, such as mobile pressure systems or long tubing runs culminating at a compressor, will benefit from the use of High Pressure Equipment Company's Anti-Vibration Gland Assemblies. These assemblies utilize the same reliable connection geometries as the standard HiP fittings, with the added benefit of essentially unlimited vibrational fatigue life.

A coned and threaded tube, when subjected to unusual or excessive vibration, may fail prematurely and break at the last thread. The Anti-Vibration Gland Assembly acts to move the fulcrum of vibration away from the threaded portion of the tube and onto the strong, solid wall of the tubing. A wedge-like collet firmly holds the assembly in place, virtually eliminating premature tubing failure while reliably maintaining a leak-free connection between the tube and the connection seat.

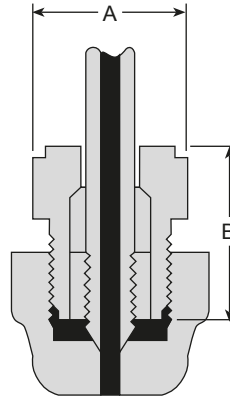

High Pressure Anti-Vibration Gland Assemblies

| Catalog No. | Pressure Rating psi | Connections | A | B |
|-------------|---------------------|---------------------|----------|---------|
| 60-3HM4 | 60,000 | 1/4" HIGH PRESSURE | 5/8" | 13/16" |
| 60-3HM6 | 60,000 | 3/8" HIGH PRESSURE | 13/16" | 1 1/8" |
| 60-3HM9 | 60,000 | 9/16" HIGH PRESSURE | 1 13/16" | 1 9/16" |
| 40-3HM9 | 40,000 | 9/16" HIGH PRESSURE | 1 13/16" | 1 9/16" |

Anti-Vibration Components

| Tubing Size | Slotted Collet | Collet Gland | Collar |
|-------------|----------------|--------------|--------|
| 1/4" | 2-8784 | 2-8783 | 60-2H4 |
| 3/8" | 2-8786 | 2-8785 | 60-2H6 |
| 9/16" | 2-8788 | 2-8787 | 60-2H9 |



High Pressure Equipment

High Pressure Tubing

Tubing is cold drawn, seamless, and is supplied in the $\frac{1}{8}$ " hard condition (not annealed). Tensile strength is approximately 40 percent higher than that of annealed tubing. All tubing is manufactured in strict accordance with High Pressure Equipment Company specifications to insure tolerances and bore quality. Tubing is stocked in lengths of 18 to 22 feet but may be ordered in shorter lengths with **no additional cutting charge**.

Note: The $\frac{1}{8}$ " O.D. tubing sizes may be coiled for shipment. Larger sizes must be shipped in straight lengths.

| | Tubing Size | Working Pressure psi | Type of Connection Used | Material | Catalog Order Number |
|-----------------------------------|-----------------------------------------------|----------------------|--------------------------------------|----------|----------------------|
| $\frac{1}{8}$" | $\frac{1}{8}$ " O.D. x 0.020" I.D. | 60,000 | $\frac{1}{8}$ " HIGH PRESSURE (HF2) | 316 SS | 60-9H2 |
| | $\frac{1}{8}$ " O.D. x 0.040" I.D. | 30,000 | $\frac{1}{8}$ " HIGH PRESSURE (HF2) | 316 SS | 30-9H2 |
| $\frac{1}{4}$" | $\frac{1}{4}$ " O.D. x 0.083" I.D. | 60,000 | $\frac{1}{4}$ " HIGH PRESSURE (HF4) | 316 SS * | 60-9H4-316 |
| | | | | 304 SS * | 60-9H4-304 |
| $\frac{3}{8}$" | $\frac{3}{8}$ " O.D. x $\frac{1}{8}$ " I.D. | 60,000 | $\frac{3}{8}$ " HIGH PRESSURE (HF6) | 316 SS | 60-9H6-316 |
| | | | | 304 SS | 60-9H6-304 |
| $\frac{9}{16}$" | $\frac{9}{16}$ " O.D. x $\frac{3}{16}$ " I.D. | 60,000 | $\frac{9}{16}$ " HIGH PRESSURE (HF9) | 316 SS | 60-9H9-316 |
| | | | | 304 SS | 60-9H9-304 |
| $\frac{9}{16}$" | $\frac{9}{16}$ " O.D. x $\frac{1}{4}$ " I.D. | 40,000 | $\frac{9}{16}$ " HIGH PRESSURE (HF9) | 316 SS | 40-9H9-316 |
| | | | | 304 SS | 40-9H9-304 |
| 1" | 1" O.D. x 0.437" I.D. | 30,000 | 1" HIGH PRESSURE (HF16) | 316 SS | 30-9H16-316 |

Nipples

Nipples as shown below are stocked in Types 304 and 316 Stainless Steel. Nipples in lengths other than those shown are supplied upon request. Nipples are not furnished with collars and glands, unless specified at time of order.

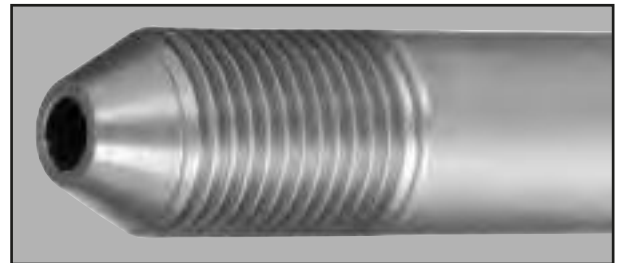

Coned and Threaded Nipples

| Length ↓ | Tubing Size (O.D. x I.D.) | | | | | | |
|-------------------|---------------------------|-----------------------------|--------------------------|-------------------------------------|--------------------------------------|---------------------------------------|----------------|
| | $\frac{1}{8}$ " x 0.020" | $\frac{1}{8}$ " x 0.040" ** | $\frac{1}{4}$ " x 0.083" | $\frac{3}{8}$ " x $\frac{1}{8}$ " * | $\frac{9}{16}$ " x $\frac{1}{4}$ " * | $\frac{9}{16}$ " x $\frac{3}{16}$ " * | 1" x 0.437" ** |
| psi → | 60,000 psi | 30,000 psi | 60,000 psi | 60,000 psi | 40,000 psi | 60,000 psi | 30,000 psi |
| 2" | 60-HM2-2 | 30-HM2-2 | | | | | |
| 2 $\frac{3}{4}$ " | | | 60-HM4-2.75 | | | | |
| 3" | 60-HM2-3 | 30-HM2-3 | | 60-HM6-3 | | | |
| 4" | 60-HM2-4 | 30-HM2-4 | | | 40-HM9-4 | 60-HM9-4 | |
| 6" | 60-HM2-6 | 30-HM2-6 | 60-HM4-6 | 60-HM6-6 | 40-HM9-6 | 60-HM9-6 | 30-HM16-6 |
| 8" | | | 60-HM4-8 | 60-HM6-8 | 40-HM9-8 | 60-HM9-8 | 30-HM16-8 |
| 9" | 60-HM2-9 | 30-HM2-9 | | | | | |
| 10" | | | 60-HM4-10 | 60-HM6-10 | 40-HM9-10 | 60-HM9-10 | 30-HM16-10 |
| 12" | 60-HM2-12 | 30-HM2-12 | 60-HM4-12 | 60-HM6-12 | 40-HM9-12 | 60-HM9-12 | 30-HM16-12 |

Specify 316 SS or 304 SS when ordering. * Also used for 30,000 psi series. ** 316 SS

High Pressure Connections

(Coned and Threaded) 30,000/40,000/60,000 psi service

The High Pressure tubing connection is available for 1/8", 1/4", 3/8", 9/16" and 1" O.D. tubing. The tubing may be prepared with the use of tooling (see tooling section 9.0) or prepared at the factory to specified lengths. Additionally, standard length coned and threaded tubing nipples are available from stock (see page 4.12).

This connection has become an industry standard for use at elevated pressures and temperatures in both liquid and gas applications. It may be disassembled and retightened indefinitely.

The threads of the gland are right-hand while the threads of the collar and tubing are left-hand to prevent rotation of the collar during assembly.

Materials

All of the components required for make-up of a High Pressure connection (glands, collars and plugs) are produced in Type 316 stainless steel.

Glands and collars.

All valves and fittings are provided (except nipples) unless otherwise requested. (See chart on the right for size details and catalog numbers).

| 30,000 & 60,000 psi | | | 40,000 psi | 30,000 psi |
|------------------------------|-------------------------|-------------------------|--------------------------|------------------------|
| HF2 1/8" O.D. Tubing | HF4 1/4" O.D. Tubing | HF6 3/8" O.D. Tubing | HF9 9/16" O.D. Tubing | HF16 1" O.D. Tubing |
| Female Opening Detail | | | | |
| | | | | |
| HF2 | HF4 | HF6 | HF9 | HF16 |
| Gland | | | | |
| | | | | |
| 60-2HM2 | 60-2HM4 | 60-2HM6 | 60-2HM9 | 60-2HM9 |
| Collar | | | | |
| | | | | |
| 60-2H2 | 60-2H4 | 60-2H6 | 60-2H9 | 60-2H9 |
| Plug | | | | |
| | | | | |
| 60-7HM2 | 60-7HM4 | 60-7HM6 | 60-7HM9 | 40-7HM9 |
| Tube End Prep | | | | |
| | | | | |
| HM2 | HM4 | HM6 | HM9 | HM9 |
| | | | | |
| HM16 | | | | |

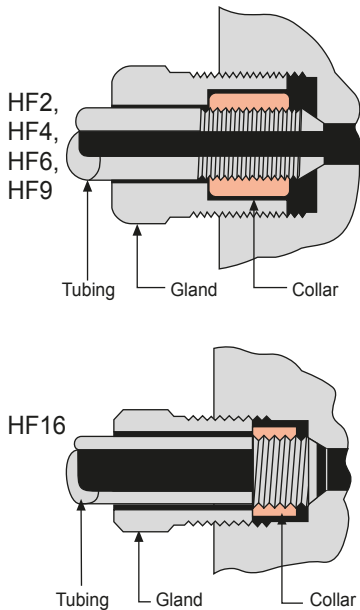



High Pressure Equipment

Ultra High Pressure Valves, Fittings and Tubing **100,000 and 150,000 psi service**

High Pressure Equipment Company has developed a line of Ultra High Pressure products to assure safe and easy plumbing for 100,000 psi and 150,000 psi. These needle valves, fittings, check valves, tubing and nipples are engineered to the highest standards of repeatable quality. The reliable performance of these products has made HiP one of the world's leading suppliers of elevated pressure components.

Ultra High Pressure components use a coned-and-threaded connection which accommodates the extreme conditions found in these applications. Ultra High Pressure valves are available in $\frac{1}{4}$ " and $\frac{3}{8}$ " O.D. tubing sizes and four patterns to satisfy widely varied requirements. A line of fittings is available to facilitate adapting to High Pressure systems.



Index

| | Page |
|--------------------------------------|----------|
| 100,000 psi Valves | 5.2 |
| 150,000 psi Valves | 5.3 |
| Fittings | 5.4 |
| Check Valves | 5.4 |
| Tubing | 5.5 |
| Coned and Threaded Nipples | 5.5 |
| Connection Details | 5.A |
| | Appendix |



High Pressure Equipment

Ultra High Pressure Valves 100,000 psi service

High Pressure (coned and threaded) type connections for $\frac{1}{4}$ " O.D. by $\frac{1}{16}$ " I.D. tubing.

Non-rotating tip stems insure long life on valve seats. Heavy duty "rolled style" stem design is shown below.

Glands and collars for tubing are supplied with each valve unless otherwise requested (glands and collars are shown on page 5.A).

Materials include 316 stainless steel for valve bodies with tool steel lower section stems. Valve packing is teflon.

Corresponding fittings (elbows, tees, crosses, etc.) are shown on page 5.4.

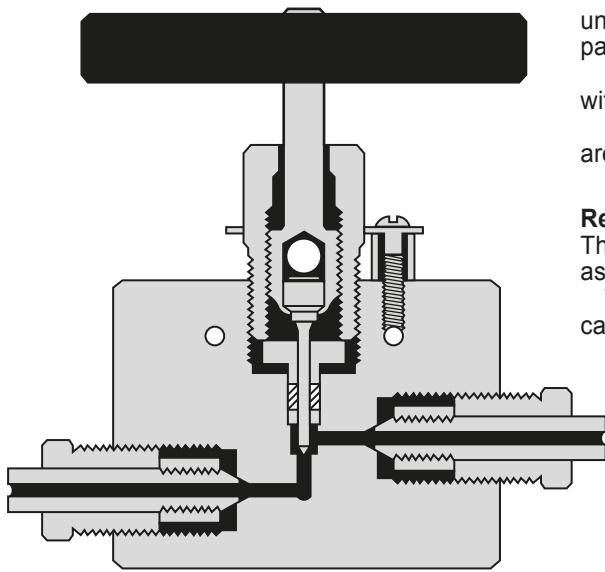

Replaceable Seat Valves are available for $\frac{1}{4}$ " O.D. tubing. These valves feature the same body style and body dimensions as the two way angle valves (shown below).

To order add "R" to the corresponding two way valve catalog number (eg. 100-12XF4R).

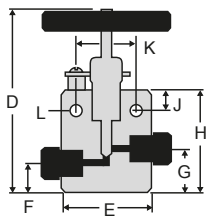

Two Way
Straight

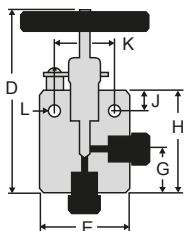

Two Way
Angle

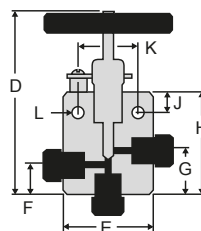

Three Way
Two Inlets

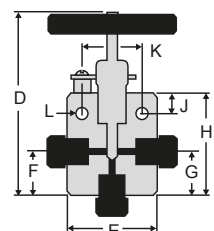

Three Way
One Inlet

Manual Shutoff Valves

| Body Pattern | Tubing | Catalog No. | psi | Connection | Orifice | D | E | F | G | H | J | K | L | Thickness |
|----------------|----------------------|-------------|---------|------------|------------------|------------------|------------------|-------------------|-------------------|------------------|-----------------|------------------|------------------|------------------|
| 2-Way Straight | $\frac{1}{4}$ " O.D. | 100-11XF4 | 100,000 | XF4 | $\frac{1}{16}$ " | 5" | $2\frac{5}{8}$ " | $\frac{3}{4}$ " | $1\frac{1}{16}$ " | $2\frac{1}{2}$ " | $\frac{1}{2}$ " | $1\frac{5}{8}$ " | $\frac{7}{32}$ " | $1\frac{1}{2}$ " |
| 2-Way Angle | $\frac{1}{4}$ " O.D. | 100-12XF4 | 100,000 | XF4 | $\frac{1}{16}$ " | $5\frac{1}{4}$ " | $2\frac{5}{8}$ " | — | $1\frac{5}{16}$ " | $2\frac{3}{4}$ " | $\frac{1}{2}$ " | $1\frac{5}{8}$ " | $\frac{7}{32}$ " | $1\frac{1}{2}$ " |
| 3-Way/2 Inlets | $\frac{1}{4}$ " O.D. | 100-13XF4 | 100,000 | XF4 | $\frac{1}{16}$ " | $5\frac{1}{2}$ " | $2\frac{5}{8}$ " | $1\frac{1}{4}$ " | $1\frac{9}{16}$ " | 3" | $\frac{1}{2}$ " | $1\frac{5}{8}$ " | $\frac{7}{32}$ " | $1\frac{1}{2}$ " |
| 3-Way/1 Inlet | $\frac{1}{4}$ " O.D. | 100-14XF4 | 100,000 | XF4 | $\frac{1}{16}$ " | $5\frac{1}{4}$ " | $2\frac{5}{8}$ " | $1\frac{5}{16}$ " | $1\frac{5}{16}$ " | $2\frac{3}{4}$ " | $\frac{1}{2}$ " | $1\frac{5}{8}$ " | $\frac{7}{32}$ " | $1\frac{1}{2}$ " |

Ultra High Pressure Valves 150,000 psi service

High Pressure (coned and threaded) type connections for $\frac{3}{8}$ " O.D. by $\frac{1}{16}$ " I.D. tubing.

Non-rotating tip stems insure long life on valve seats. Heavy duty "rolled style" stem design is shown below.

Glands and collars for tubing are supplied with each valve unless otherwise requested (glands and collars are shown on page 5.A).

Materials include 17-4 PH for valve bodies with tool steel lower section stems. Valve packing is teflon.

Corresponding fittings (elbows, tees, crosses, etc.) are shown on page 5.4.

Replaceable Seat Valves are available for $\frac{3}{8}$ " O.D. tubing. These valves feature the same body style and dimensions as the two way valves (shown below).

To order add "R" to the corresponding two way valve catalog number (eg. 150-12XF6R).

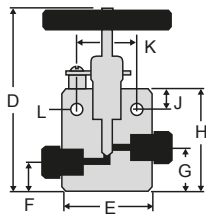
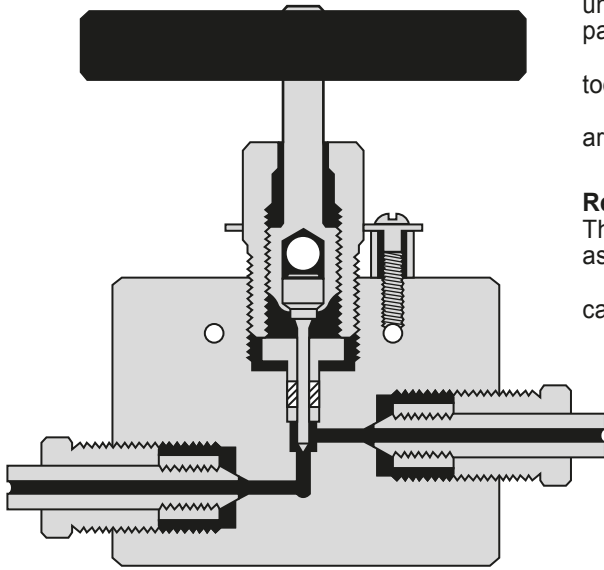

Two Way
Straight

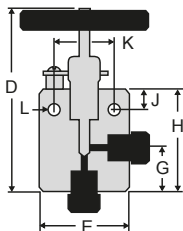

Two Way
Angle

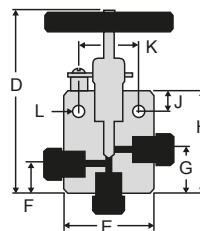

Three Way
Two Inlets

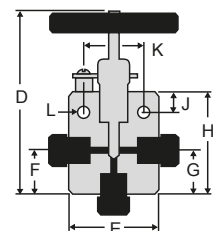

Three Way
One Inlet

Manual Shutoff Valves

| Body Pattern | Tubing | Catalog No. | psi | Connection | Orifice | D | E | F | G | H | J | K | L | Thickness |
|----------------|----------------------|-------------|---------|------------|------------------|------------------|------------------|-------------------|-------------------|------------------|-----------------|------------------|------------------|------------------|
| 2-Way Straight | $\frac{3}{8}$ " O.D. | 150-11XF6 | 150,000 | XF6 | $\frac{1}{16}$ " | 5" | $3\frac{1}{2}$ " | $\frac{7}{16}$ " | $1\frac{3}{16}$ " | $2\frac{5}{8}$ " | $\frac{1}{2}$ " | $1\frac{5}{8}$ " | $\frac{7}{32}$ " | $1\frac{1}{2}$ " |
| 2-Way Angle | $\frac{3}{8}$ " O.D. | 150-12XF6 | 150,000 | XF6 | $\frac{1}{16}$ " | $5\frac{7}{8}$ " | $3\frac{1}{2}$ " | — | $2\frac{1}{16}$ " | $3\frac{1}{2}$ " | $\frac{1}{2}$ " | $1\frac{5}{8}$ " | $\frac{7}{32}$ " | $1\frac{1}{2}$ " |
| 3-Way/2 Inlets | $\frac{3}{8}$ " O.D. | 150-13XF6 | 150,000 | XF6 | $\frac{1}{16}$ " | $5\frac{7}{8}$ " | $3\frac{1}{2}$ " | $1\frac{3}{4}$ " | $2\frac{1}{16}$ " | $3\frac{1}{2}$ " | $\frac{1}{2}$ " | $1\frac{5}{8}$ " | $\frac{7}{32}$ " | $1\frac{1}{2}$ " |
| 3-Way/1 Inlet | $\frac{3}{8}$ " O.D. | 150-14XF6 | 150,000 | XF6 | $\frac{1}{16}$ " | $5\frac{7}{8}$ " | $3\frac{1}{2}$ " | $2\frac{1}{16}$ " | $2\frac{1}{16}$ " | $3\frac{1}{2}$ " | $\frac{1}{2}$ " | $1\frac{5}{8}$ " | $\frac{7}{32}$ " | $1\frac{1}{2}$ " |



High Pressure Equipment

Fittings/Check Valves

We have developed check valves, elbows, tees and crosses for both the 100,000 and 150,000 psi systems.
*Material is high tensile 316 stainless steel. Standard tubing glands and collars are furnished unless otherwise specified.

* **Note:** Material for 150,000 psi check valve is 17-4 PH.

Ultra High Pressure Check Valves

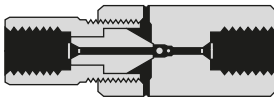

| Catalog No. | psi | Connections | Length | Hex |
|-------------|---------|---------------------|----------------------------------|--------|
| 100-41XF4 | 100,000 | 1/4" ULTRA PRESSURE | 3 ⁹ / ₁₆ " | 1 1/2" |
| 150-41XF6 | 150,000 | 3/8" ULTRA PRESSURE | 4 1/2" | 1 1/2" |

Ultra High Pressure Elbows

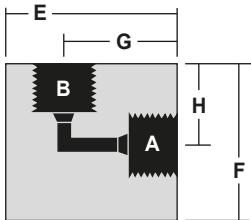

| Catalog No. | Pressure Rating psi | Connections | A-B-C-D | E | F | G | H | Thickness |
|-------------|---------------------|----------------|---------|---------------------------------|---------------------------------|---------------------------------|---------------------------------|-----------|
| 100-22XF4 | 100,000 | 1/4" O.D. TUBE | XF4 | 1 ³ / ₄ " | 1 ³ / ₄ " | 1 ¹ / ₄ " | 1 ¹ / ₄ " | 1" |
| 150-22XF6 | 150,000 | 3/8" O.D. TUBE | XF6 | 2 ⁵ / ₈ " | 2 ⁵ / ₈ " | 1 ³ / ₄ " | 1 ³ / ₄ " | 1 1/2" |

Ultra High Pressure Tees

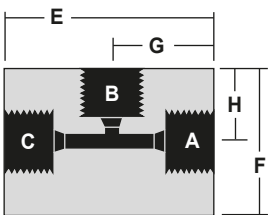

| Catalog No. | Pressure Rating psi | Connections | A-B-C-D | E | F | G | H | Thickness |
|-------------|---------------------|----------------|---------|--------|---------------------------------|---------------------------------|---------------------------------|-----------|
| 100-23XF4 | 100,000 | 1/4" O.D. TUBE | XF4 | 2 1/2" | 1 ³ / ₄ " | 1 ¹ / ₄ " | 1 ¹ / ₄ " | 1" |
| 150-23XF6 | 150,000 | 3/8" O.D. TUBE | XF6 | 3 1/2" | 2 ⁵ / ₈ " | 1 ³ / ₄ " | 1 ³ / ₄ " | 1 1/2" |

Ultra High Pressure Crosses

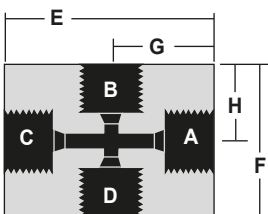

| Catalog No. | Pressure Rating psi | Connections | A-B-C-D | E | F | G | H | Thickness |
|-------------|---------------------|----------------|---------|--------|--------|---------------------------------|---------------------------------|-----------|
| 100-24XF4 | 100,000 | 1/4" O.D. TUBE | XF4 | 2 1/2" | 2 1/2" | 1 ¹ / ₄ " | 1 ¹ / ₄ " | 1" |
| 150-24XF6 | 150,000 | 3/8" O.D. TUBE | XF6 | 3 1/2" | 3 1/2" | 1 ³ / ₄ " | 1 ³ / ₄ " | 1 1/2" |

Ultra High Pressure Tubing

Tubing is cold drawn, seamless, and is supplied in the $\frac{1}{8}$ hard condition (not annealed). Tensile strength is approximately 40 percent higher than that of annealed tubing. All tubing is manufactured in strict accordance with High Pressure Equipment Company specifications to insure tolerances and bore quality. Tubing is stocked in lengths of 18 to 22 feet but may be ordered in shorter lengths with **no additional cutting charge**.



| | Tubing Size | Working Pressure psi | Type of Connection Used | Material | Catalog Order Number |
|----------------------------------|----------------------------------------------|----------------------|-------------------------------------------|----------|----------------------|
| $\frac{1}{4}$" | $\frac{1}{4}$ " O.D. x $\frac{1}{16}$ " I.D. | 100,000 | $\frac{1}{4}$ " ULTRA HIGH PRESSURE (XF4) | 316 SS | 100-9X4-316 |
| | | | | 304 SS | 100-9X4-304 |
| $\frac{3}{8}$" | $\frac{3}{8}$ " O.D. x $\frac{1}{16}$ " I.D. | 150,000 | $\frac{3}{8}$ " ULTRA HIGH PRESSURE (XF6) | 304 SS | 150-9X6 |

Nipples

Nipples in lengths other than those shown are supplied upon request. Nipples are not furnished with collars and glands, unless specified at time of order.



Coned and Threaded Nipples

| Length ↓ | Tubing Size (O.D. x I.D.) | | |
|-----------------------------------|----------------------------------------------------------|----------------------------------------------------------|----------------------------------------------------------|
| | $\frac{1}{4}$ " O.D. x $\frac{1}{16}$ " I.D. (316 SS) | $\frac{1}{4}$ " O.D. x $\frac{1}{16}$ " I.D. (304 SS) | $\frac{3}{8}$ " O.D. x $\frac{1}{16}$ " I.D. (304 SS) |
| psi → | 100,000 psi | 100,000 psi | 150,000 psi |
| $2\frac{3}{4}$" | 100-XM4-2.75 | 100-XM4-2.75 | |
| 4" | | | 150-XM6-4 |
| 6" | 100-XM4-6 | 100-XM4-6 | 150-XM6-6 |
| 8" | 100-XM4-8 | 100-XM4-8 | 150-XM6-8 |
| 10" | 100-XM4-10 | 100-XM4-10 | 150-XM6-10 |
| 12" | 100-XM4-12 | 100-XM4-12 | 150-XM6-12 |



High Pressure Equipment

Ultra High Pressure Connections

**(Coned and Threaded)
100,000 and 150,000 psi service**

The Ultra High Pressure tubing connection is available for 1/4" and 3/8" O.D. tubing. The tubing may be prepared with the use of tooling (see tooling section 9.0) or prepared at the factory to specified lengths. Additionally, standard length coned and threaded nipples are available from stock, see page 5.5.

This connection has become an industry standard for use at elevated pressures and temperatures in both liquid and gas applications. It may be disassembled and retightened indefinitely.

The threads of the gland are right-hand while the threads of the collar and tubing are left-hand to prevent rotation of the collar during assembly.

Materials. All of the components required for make-up of a Ultra High Pressure connection (glands, collars and plugs) are produced in Type 316 stainless steel.

Necessary glands and collars are provided with all valves and fittings (except nipples) unless otherwise requested (see chart on the right for size details and catalog numbers).

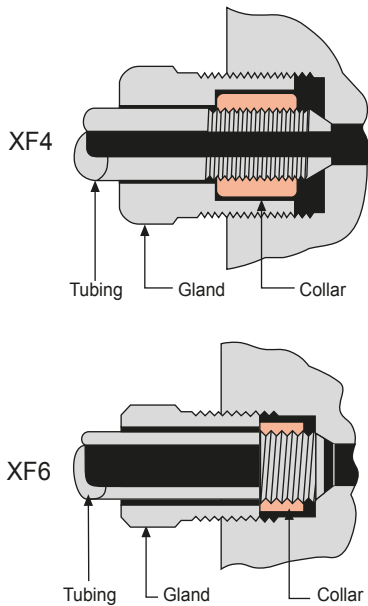

| 100,000 psi XF4 1/4" O.D. Tubing | 150,000 psi XF6 3/8" O.D. Tubing |
|-----------------------------------------------|-----------------------------------------------|
| Female Opening Detail | |
| Gland | |
| Collar | |
| Plug | |
| Tube End Prep | |



High Pressure Equipment

Specialty Valves

High Pressure Equipment Company produces many valves engineered for specific requirements and operating conditions.

Ball Valves provide shut-off of liquid or gas flow through 20,000 psi. These valves are available in two way and three way configurations.

Hastelloy Valves are the most common special material valves we produce. We maintain an inventory of Hastelloy C-276 to assure prompt delivery.

High Temperature Valves feature an extension to remove the packing area (stuffing box) from the hot zone of a valve, making them suitable for use at 1,000°F (538°C).

Micro Control Metering Valves are designed to assure the fine and precise stem travel necessary for excellent control of flow. An integral vernier indicator provides exact measurement of stem revolution.

Relief Valves protect a system from over-pressure damage and failure. Relief Valves are offered in pressure ranges: 3,000 psi to 30,000 psi.

Male Bottom Connection Valves are designed for applications where extra rigidity or space restrictions are critical. These valves feature one-piece stem construction to increase durability and reduce overall height.

Block and Bleed Valves
These two stem manifold valves are an excellent method of blocking, bleeding and calibrating pressure gauges and transmitters.

Subsea Ball Valves
Designed for extreme pressures and harsh environments, the industry's broadest line of subsea ball valves for 10, 15 and 20,000 psi.



Index

Page

| | |
|-----------------------------------------|-----------|
| Ball Valves | 6.2-6.5 |
| Hastelloy Valves | 6.6 |
| High Temperature Valves | 6.6 |
| Metering Valves | 6.7 |
| Relief Valves | 6.8 |
| Male Bottom Connection Valves | 6.9 |
| Block and Bleed Valves | 6.10-6.11 |
| Subsea Ball Valves | 6.12-6.15 |



High Pressure Equipment

Ball Valves

10,000, 15,000 and 20,000 psi service

High Pressure Equipment offers two styles of ball valves (free floating and trunion) to provide effective shut-off of liquid or gas flow.

Two-way ball valves offer complete shut-off with a convenient $\frac{1}{4}$ turn. Valve actuators are available for remote control of HiP ball valves.

Virtually all metal components are stainless steel to insure consistent operation under even the most severe applications. Teflon packing provides reliable leak-free service up to 400°F. Other packings, including Polypak and Grafoil are available upon request.

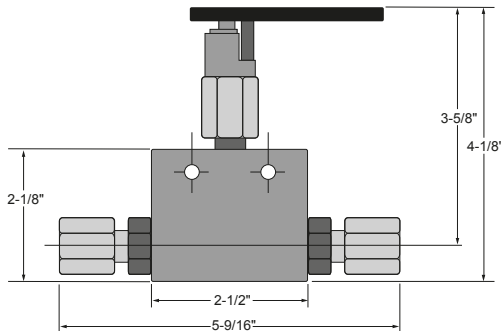

Two-Way Free Floating Ball Valves

| Catalog No. | Tube Size | Conn* | Pressure Rating @RT | Minimum Orifice | C _v |
|-------------|------------------|---------------------|---------------------|-----------------|----------------|
| 15-16AF1 | $\frac{1}{16}$ " | AF1 | 15,000 psi | 0.052 | 0.09 |
| 15-16AF2 | $\frac{1}{8}$ " | AF2 | 15,000 psi | 0.094 | 0.20 |
| 10-16AF4 | $\frac{1}{4}$ " | AF4 | 10,000 psi | 0.125 | 0.45 |
| 10-16AF6 | $\frac{3}{8}$ " | AF6 | 10,000 psi | 0.250 | 2.70 |
| 20-16LF4 | $\frac{1}{4}$ " | LF4 | 20,000 psi | 0.109 | 0.31 |
| 20-16LF6 | $\frac{3}{8}$ " | LF6 | 20,000 psi | 0.203 | 1.70 |
| 20-16LF9 | $\frac{9}{16}$ " | LF9 | 20,000 psi | 0.250 | 2.70 |
| 20-16HF2 | $\frac{1}{8}$ " | HF2 | 20,000 psi | 0.062 | 0.12 |
| 20-16HF4 | $\frac{1}{4}$ " | HF4 | 20,000 psi | 0.094 | 0.20 |
| 20-16HF6 | $\frac{3}{8}$ " | HF6 | 20,000 psi | 0.125 | 0.45 |
| 20-16HF9 | $\frac{9}{16}$ " | HF9 | 20,000 psi | 0.188 | 1.45 |
| 10-16NFA | $\frac{1}{8}$ " | $\frac{1}{8}$ " NPT | 10,000 psi | 0.250 | 2.70 |
| 10-16NFB | $\frac{1}{4}$ " | $\frac{1}{4}$ " NPT | 10,000 psi | 0.250 | 2.70 |
| 10-16NFC | $\frac{3}{8}$ " | $\frac{3}{8}$ " NPT | 10,000 psi | 0.250 | 2.70 |
| 10-16NFD | $\frac{1}{2}$ " | $\frac{1}{2}$ " NPT | 10,000 psi | 0.250 | 2.70 |

* Other connections available upon request. Consult factory.

Severe Duty Ball Valves (Trunion Style)

10,000, 15,000 and 20,000 psi service

High Pressure Equipment Company introduces its TRUNION STYLE ball valves for effective shut-off of liquid and gas flow through 20,000 psi @ 400°F maximum. Our offering features a trunion ball design, making this type of valve ideal for severe duty applications. This valve is available in two-way or three-way configurations with orifices of .187", .375" or .500".

The two-way ball valve offers complete shut-off with a convenient 1/4 turn. The standard configuration of the three-way ball valve requires 1/2 turn to change port outlets and provides for complete shut-off. An optional diverter style three-way ball valve requires only a 1/4 turn to change the port outlets. Air operated actuators are available for remote control.

Material of construction is 316 stainless steel, O-rings are Viton, ball seat is PEEK. Alternate materials of construction are available upon request.

- Trunion style closure, ideal for severe duty applications
- Two-way and three-way valve configurations
- Three-way, 1/4 turn diverter valve
- .187", .375" or .500" orifices
- Air actuators for remote operation
- Convenient panel mount design (cut 1 1/16" diameter hole) .187 and .375 only
- Large selection of tube and pipe fittings available
- Optional wetted parts available
- Optional O-rings available



Two-Way Trunion Ball Valves - 90°

| Orifice | Tube Size | Connection | Pressure Rating | Minimum Orifice | C _v | A | Catalog No. |
|---------|-----------|------------|-----------------|-----------------|----------------|----------|-------------|
| .187 | 1/16" | AF1 | 15,000 psi | .052 | 0.09 | 4.19 | 15-71AF1 |
| | 1/8" | AF2 | 15,000 psi | .094 | 0.20 | 4.19 | 15-71AF2 |
| | 1/4" | AF4 | 10,000 psi | .125 | 0.45 | 4.69 | 10-71AF4 |
| | 3/8" | AF6 | 10,000 psi | .187 | 1.45 | 4.69 | 10-71AF6 |
| | 1/4" | LF4 | 20,000 psi | .109 | 0.31 | 4.63 | 20-71LF4 |
| | 3/8" | LF6 | 20,000 psi | .187 | 1.45 | 4.63 | 20-71LF6 |
| | 9/16" | LF9 | 20,000 psi | .187 | 1.45 | 5.13 | 20-71LF9 |
| | 1/4" | HF4 | 20,000 psi | .094 | 0.20 | 4.63 | 20-71HF4 |
| | 3/8" | HF6 | 20,000 psi | .125 | 0.45 | 4.63 | 20-71HF6 |
| | 9/16" | HF9 | 20,000 psi | .187 | 1.45 | 4.87 | 20-71HF9 |
| | 1/8" | 1/8" NPT | 15,000 psi | .187 | 1.45 | 4.63 | 15-71NFA |
| | 1/4" | 1/4" NPT | 15,000 psi | .187 | 1.45 | 4.63 | 15-71NFB |
| 3/8" | 3/8" NPT | 15,000 psi | .187 | 1.45 | 4.65 | 15-71NFC | |
| .375 | 3/8" | AF6 | 10,000 psi | .250 | 2.70 | 5.13 | 10-74AF6 |
| | 9/16" | LF9 | 15,000 psi | .312 | 4.22 | 6.25 | 15-74LF9 |
| | 3/4" | LF12 | 15,000 psi | .375 | 6.08 | 6.67 | 15-74LF12 |
| | 1" | LF16 | 15,000 psi | .375 | 6.08 | 7.45 | 15-74LF16 |
| | 1/4" | 1/4" NPT | 15,000 psi | .250 | 2.70 | 5.63 | 15-74NFB |
| | 3/8" | 3/8" NPT | 15,000 psi | .375 | 6.08 | 5.63 | 15-74NFC |
| .500 | 3/4" | LF12 | 10,000 psi | .500 | 19.3 | 6.56 | 10-80LF12 |
| | 1" | LF16 | 10,000 psi | .500 | 19.3 | 7.44 | 10-80LF16 |
| | 3/4" | 3/4" NPT | 10,000 psi | .500 | 19.3 | 6.44 | 10-80NFF |
| | 1" | 1" NPT | 10,000 psi | .500 | 19.3 | 7.44 | 10-80NFH |

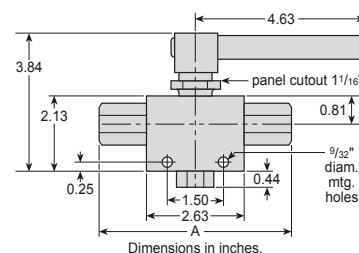

.187 Orifice

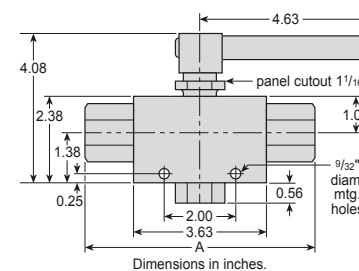

.375 Orifice

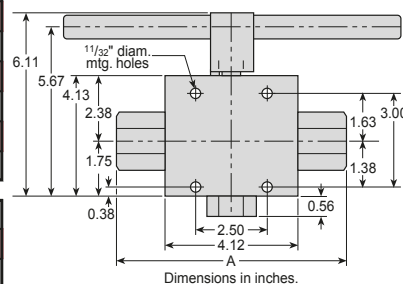

.500 Orifice

Three-Way Trunion Ball Valves

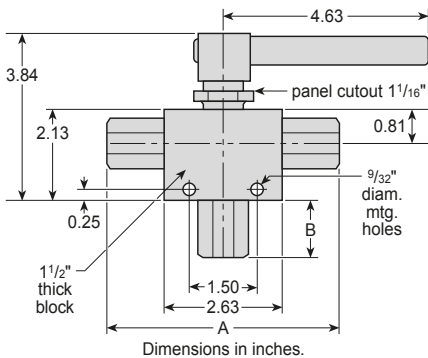

.187 Orifice

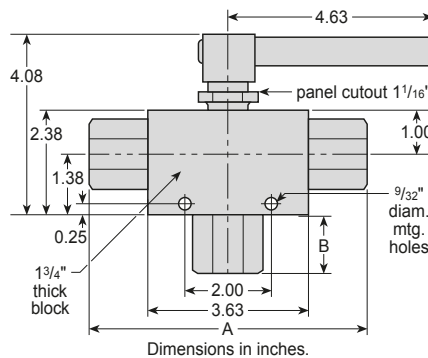

.375 Orifice

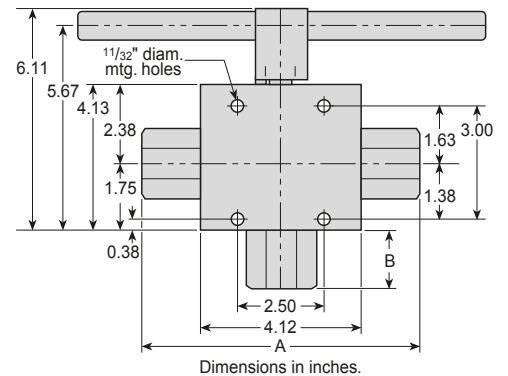

.500 Orifice

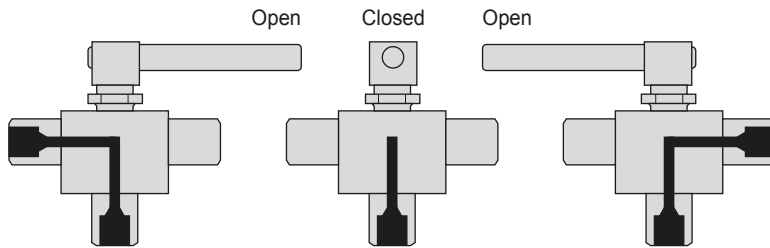

180° Three-Way Ball Valve

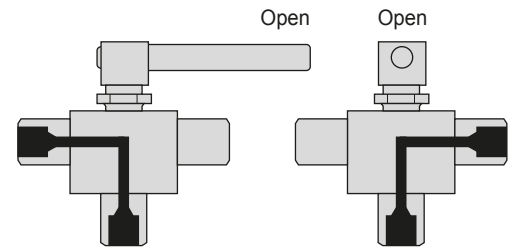

90° Three-Way Diverter Valve

| Orifice | Tube Size | Connection | Pressure Rating | Minimum Orifice | C _v | A | B | 3-Way 90° Catalog No. | 3-Way 180° Catalog No. |
|---------|-----------|------------|-----------------|-----------------|----------------|------|----------|-----------------------|------------------------|
| .187 | 1/16" | AF1 | 15,000 psi | .052 | 0.04 | 4.19 | 0.55 | 15-73AF1 | 15-72AF1 |
| | 1/8" | AF2 | 15,000 psi | .094 | 0.10 | 4.19 | 0.55 | 15-73AF2 | 15-72AF2 |
| | 1/4" | AF4 | 10,000 psi | .125 | 0.22 | 4.69 | 0.83 | 10-73AF4 | 10-72AF4 |
| | 3/8" | AF6 | 10,000 psi | .187 | 0.71 | 4.69 | 1.01 | 10-73AF6 | 10-72AF6 |
| | 1/4" | LF4 | 20,000 psi | .109 | 0.15 | 4.63 | 1.00 | 20-73LF4 | 20-72LF4 |
| | 3/8" | LF6 | 20,000 psi | .187 | 0.71 | 4.63 | 1.00 | 20-73LF6 | 20-72LF6 |
| | 9/16" | LF9 | 20,000 psi | .187 | 0.71 | 5.13 | 1.25 | 20-73LF9 | 20-72LF9 |
| | 1/4" | HF4 | 20,000 psi | .094 | 0.10 | 4.63 | 0.81 | 20-73HF4 | 20-72HF4 |
| | 3/8" | HF6 | 20,000 psi | .125 | 0.22 | 4.63 | 0.94 | 20-73HF6 | 20-72HF6 |
| | 9/16" | HF9 | 20,000 psi | .187 | 0.71 | 4.87 | 1.19 | 20-73HF9 | 20-72HF9 |
| | 1/8" | 1/8" NPT | 15,000 psi | .187 | 0.71 | 4.63 | 0.50 | 15-73NFA | 15-72NFA |
| | 1/4" | 1/4" NPT | 15,000 psi | .187 | 0.71 | 4.63 | 1.06 | 15-73NFB | 15-72NFB |
| 3/8" | 3/8" NPT | 15,000 psi | .187 | 0.71 | 4.65 | 1.06 | 15-73NFC | 15-72NFC | |
| .375 | 3/8" | AF6 | 10,000 psi | .250 | 1.07 | 5.13 | 0.75 | 10-76AF6 | 10-75AF6 |
| | 9/16" | LF9 | 15,000 psi | .312 | 1.67 | 6.25 | 1.06 | 15-76LF9 | 15-75LF9 |
| | 3/4" | LF12 | 15,000 psi | .375 | 2.40 | 6.67 | 1.18 | 15-76LF12 | 15-75LF12 |
| | 1" | LF16 | 15,000 psi | .375 | 2.40 | 7.45 | 1.99 | 15-76LF16 | 15-75LF16 |
| | 1/4" | 1/4" NPT | 15,000 psi | .250 | 1.07 | 5.63 | 1.06 | 15-76NFB | 15-75NFB |
| | 3/8" | 3/8" NPT | 15,000 psi | .375 | 2.40 | 5.63 | 1.06 | 15-76NFC | 15-75NFC |
| 1/2" | 1/2" NPT | 15,000 psi | .375 | 2.40 | 5.63 | 1.06 | 15-76NFD | 15-75NFD | |
| .500 | 3/4" | LF12 | 10,000 psi | .500 | 7.43 | 6.56 | 1.30 | 10-82LF12 | 10-81LF12 |
| | 1" | LF16 | 10,000 psi | .500 | 7.43 | 7.44 | 1.74 | 10-82LF16 | 10-81LF16 |
| | 3/4" | 3/4" NPT | 10,000 psi | .500 | 7.43 | 6.44 | 1.30 | 10-82NFF | 10-81NFF |
| | 1" | 1" NPT | 10,000 psi | .500 | 7.43 | 7.44 | 1.74 | 10-82NFH | 10-81NFH |

Ball Valve Actuators

High Pressure Equipment Company offers air operated actuators to accommodate remote operation. **NOTE: These air operators are only for use with two-way and three-way diverter style valves.**

To order: simply specify the appropriate ball valve catalog number and add the suffix “-TSR8” for air to open/spring to close, or “-TDA8” for air to open and close (double acting) or TSR20 for 0.500 orifice. For trunion only.

Use TDA4 and TSR4 for floating ball style valves.

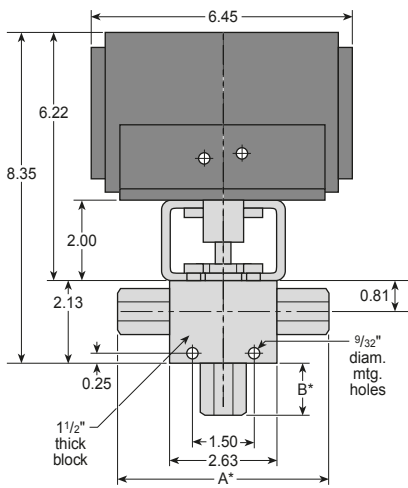

.187 Orifice

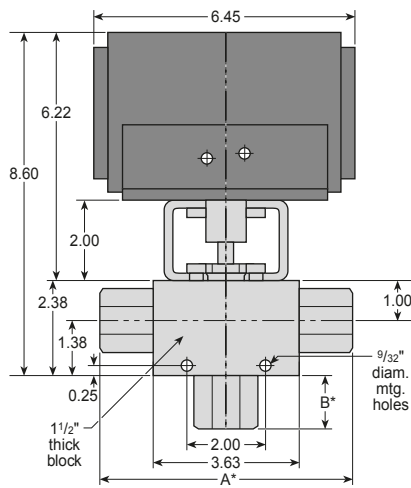

.375 Orifice

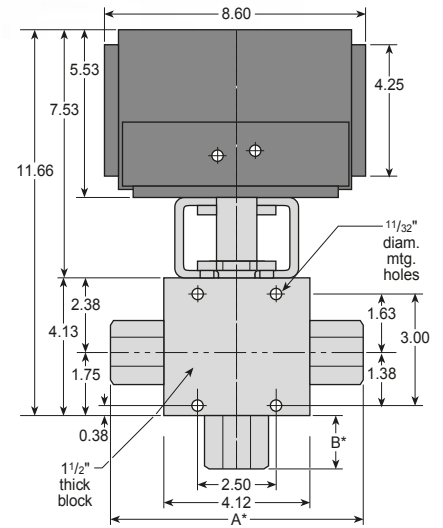

.500 Orifice



High Pressure Equipment

Hastelloy Valves

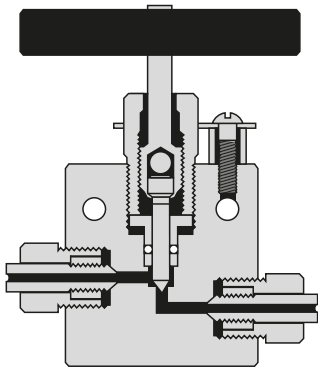

A large number of the valves and fittings shown within this catalog are frequently furnished in special materials to meet the requirements of specific applications. One of the most commonly requested "special" materials is Hastelloy C-276. While very few components are maintained in stock in special materials, a supply of Hastelloy C-276 is normally available.

The following should be observed when requesting items in Hastelloy C-276 or other special materials:

Tubing collars and glands for High Pressure coned-and-threaded connections are "non-wetted" parts which do not normally come into contact with the fluid or gas. Thus these items are supplied in 316 stainless steel unless otherwise specified.

The inner sleeve connection of the Taper Seal is a "wetted" part and must be of the same material as the valve or fitting body. The Taper Seal gland is a "non-wetted" part and is supplied in 316 stainless steel unless otherwise requested.

Physical size of Hastelloy C-276 or other special material items may vary from the dimensions of standard items shown in this catalog, depending on availability of materials. (Parts normally supplied in hex shaped material are frequently supplied in round shaped material with wrench flats when manufacturing from special materials).

Packing material in all special material valves is Teflon unless otherwise specified.

Other materials. In addition to Hastelloy C-276, valves and fittings can be furnished in Monel, Inconel, titanium and various other special materials. Consult factory for price and delivery.

High Temperature Valves

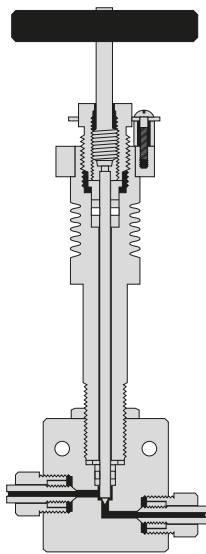

The High Temperature Extension provides a means to move the packing area (stuffing box) away from the hot zone of a valve. Fins are provided around the packing area to dissipate heat and, with proper cooling of the extension, these valves can be used at 1,000°F (538°C).

Size range. High temperature extensions are available for $\frac{1}{4}$ " O.D., $\frac{3}{8}$ " O.D., and $\frac{9}{16}$ " O.D. tubing size valves in the 30,000 psi series and for all Medium Pressure series valves.

Materials and features. Standard packing is Grafoil. Teflon packing is also available. Nonrotating tip stems prevent galling at the seats and minimize torque requirements for positive shut off.

When ordering, simply add the suffix "-HT" to the standard valve catalog number (example: 30-11HF4-HT).

Note: These valves may also be used in cryogenic applications. Teflon packing supplied.

Micro Control Metering Valves

The Micro Control Metering Valve assembly is available for all of the valves in the 60,000 psi series. This unique stem design operates on the principle of a right-hand threaded component operating in an opposite direction of motion to a left-hand threaded component.

As the pitch sizes of these threads are different from each other, a very fine and precise stem travel is made possible. This provides exceptional control that is not possible with ordinary fine pitched stem designs.

Each complete revolution of the stem provides 0.005" stem travel. The vernier indicator allows readings in increments of one-tenth of a revolution (0.0005" stem travel).

The non-rotating lower section stem is ground to a 9 degree included angle to insure maximum control. **While this valve may be turned to the fully off (closed) position, it is always preferable to provide a separate on-off valve in the system to protect the precise control of the metering valve.**

When ordering, simply specify the valve catalog number from the 60,000 psi series and add the suffix "-V" (example: 60-11HF4-V.)

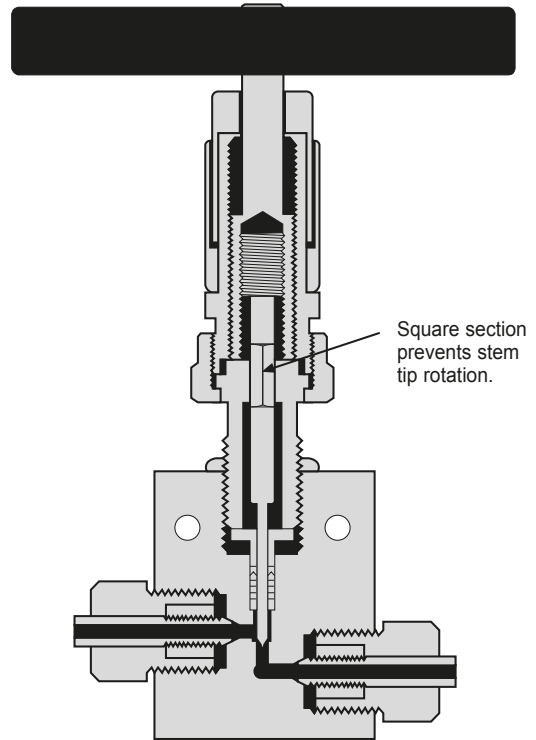

Metering Tip Valves

When the precision control offered by the above "Micro Control" metering valve is not required, a multi-piece, rolled fine pitched stem assembly can be provided. The non-rotating lower section stem is ground to a 9 degree included angle and provides a .050" stem travel per complete revolution of the handle. **While this valve may be turned to the fully off (closed) position, it is always preferable to provide a separate on-off valve in the system to protect the precise control of the metering valve.**

When ordering, simply specify valve catalog number from the 60,000 psi series and add the suffix "-MTS" (example: 60-11HF4-MTS).

For pricing consult factory.





High Pressure Equipment

Relief Valves (Factory Set)

Relief valves are offered in pressure ranges: 1,500 through 60,000 psi.

Standard materials include 316 stainless steel bodies and removable seat glands with 17-4PH stainless steel removable seats and pistons. Standard O-ring material on the piston is Viton. Valves may be used up to 350° F.

Inlet connections are for $\frac{9}{16}$ " O.D. tubing (HF9) with adapters for other sizes available. Outlet connections are $\frac{1}{2}$ " NPT.

These valves are not recommended for use below 1,500 psi, and are not readily adjustable in the field without proper test equipment. Pressure settings are made at the factory and valves are tagged accordingly.

To order, simply specify catalog number and set pressure. See table below.

| Pressure Range | Orifice Size | Type of Service* | Assembly Part No. | Max Flow Capacity H ₂ O (GPM) |
|----------------------|--------------|------------------|-------------------|------------------------------------------|
| 1,500 to 2,999 psi | 1/4" | GAS OR LIQUID | 402633-03 | 13 |
| 3,000 to 10,999 psi | 1/4" | GAS OR LIQUID | 402633-10 | 25 |
| 11,000 to 20,999 psi | 3/16" | GAS OR LIQUID | 402633-20 | 20 |
| 21,000 to 30,000 psi | 1/8" | GAS OR LIQUID | 402633-30 | 10 |
| 30,001 to 45,000 psi | 7/64" | GAS OR LIQUID | 402633-45 | 10 |
| 45,001 to 60,000 psi | 3/32" | GAS OR LIQUID | 402633-60 | 8 |

*Valves not bubble tight on gas service.

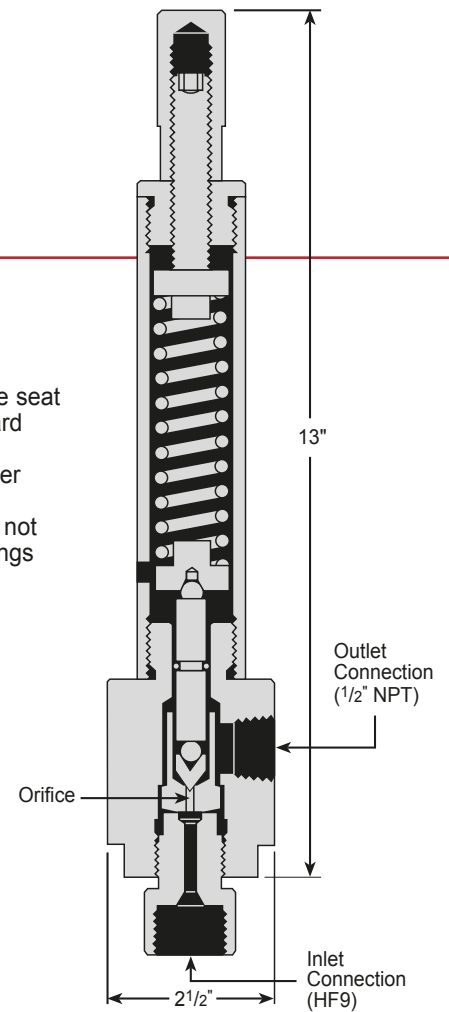

Relief Valves (Field Adjustable)

Relief valves are offered in pressure ranges: 1,000 through 20,000 psi.

Standard materials include 316 stainless steel bodies and seat glands. Standard O-ring material is EPDM, with teflon packing and nylon seats.

Inlet connections $\frac{1}{4}$ " NPT-HIP-10RV; HF4-HIP-20RV. Outlet connections are $\frac{1}{4}$ " NPT.

These valves are not recommended for use below 1,000 psi, and are readily adjustable in the field.

To order, simply specify catalog number. Example: HIP-10RV

| Pressure Range | Orifice Size | Type of Service | Part number | Cv |
|---------------------|--------------|-----------------|-------------|-----|
| 1,000 to 10,000 psi | 0.070 | GAS OR LIQUID | HIP-10RV | .12 |
| 10,001 - 20,000 psi | 0.070 | GAS OR LIQUID | HIP-20RV | .12 |

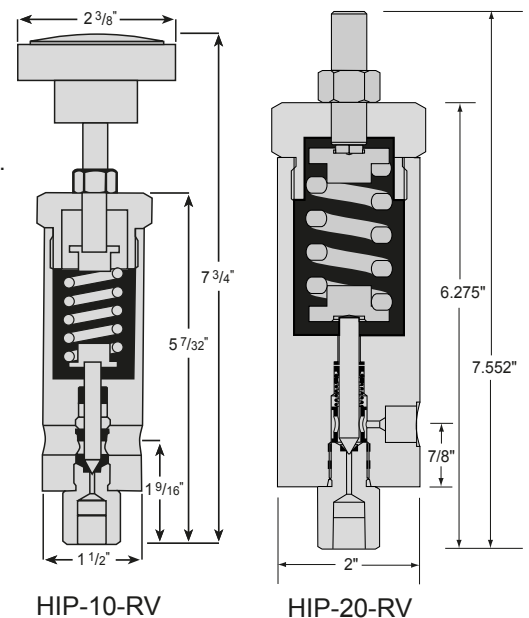

*Please note HIP-20RV does not have handle, the valve is shipped with $\frac{1}{2}$ -13" set screw.

Male Bottom Connection Valves

Connections. This series of valves is offered in a few select variations which are most frequently required. They have been developed for applications where rigidity is a major concern (such as gas bottles) and where space is restricted.

Pipe connections as well as High Pressure (coned and threaded) connections are available as listed in tables below. Additionally, these valves can be supplied with rupture disc assemblies (safety heads) installed directly into the valve body as shown (see page 3.7 for listing of rupture discs).

Stems. The Male Bottom Connection Valves are supplied with a one-piece (solid construction) stem to maximize sensitivity of "feel" and to reduce overall height. The non-rotating tip stem design as featured on other valves may be supplied as an option at no additional charge.

Materials include high tensile Type 316 stainless steel valve bodies and hardened 17-4PH stainless steel stems.

Packing is Teflon (450°F) standard with optional Viton (350°F), BUNA-N (200°F) and Grafoil (650°F) available at no additional cost.

Air operators for remote control operation are available for all valves. (Select required valve and add "HIPCO").

Rupture discs must be ordered separately (see section 3.7).

Special valves with connections other than those listed can be manufactured on special order when quantity permits. Consult factory with specifications.

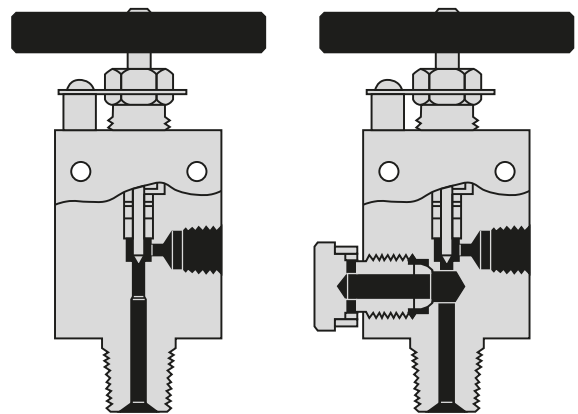

Without Safety Head

With Safety Head

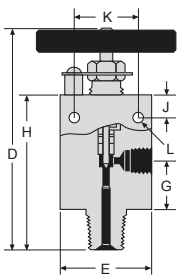

Male Bottom Connection Valves (without Safety Head)

| Assembly Number | Male Bottom | Female Side | psi | Orifice | D | E | G | H | J | K | L | Thickness |
|-----------------|-------------|-------------|--------|---------|---------|----|----------|--------|------|--------|-------|-----------|
| 2-7928A | 1/4" NPT | 1/4" NPT | 10,000 | 3/32" | 5 1/16" | 2" | 1 15/16" | 3 3/8" | 1/2" | 1 3/8" | 7/32" | 1" |
| 2-8144A | 1/4" NPT | HF4 | 10,000 | 3/32" | 5 1/16" | 2" | 1 15/16" | 3 3/8" | 1/2" | 1 3/8" | 7/32" | 1" |
| 2-7602A | 1/2" NPT | 1/4" NPT | 10,000 | 3/32" | 5 1/16" | 2" | 1 15/16" | 3 3/8" | 1/2" | 1 3/8" | 7/32" | 1" |
| 2-7569-A | 1/2" NPT | HF4 | 10,000 | 3/32" | 5 1/16" | 2" | 1 15/16" | 3 3/8" | 1/2" | 1 3/8" | 7/32" | 1" |

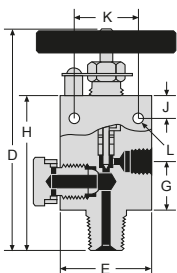

Male Bottom Connection Valves (with Safety Head)

| Assembly Number | Male Bottom | Female Side | psi | Orifice | D | E | G | H | J | K | L | Thickness |
|-----------------|-------------|-------------|--------|---------|---------|----|----------|---------|------|--------|-------|-----------|
| 2-7927A | 1/4" NPT | 1/4" NPT | 10,000 | 3/32" | 5 1/16" | 2" | 1 15/16" | 3 3/8" | 1/2" | 1 3/8" | 7/32" | 1" |
| 2-8039A | 1/4" NPT | HF4 | 10,000 | 3/32" | 5 1/16" | 2" | 1 15/16" | 3 3/8" | 1/2" | 1 3/8" | 7/32" | 1" |
| 2-7604A | 1/2" NPT | 1/4" NPT | 10,000 | 3/32" | 5 1/4" | 2" | 2 1/8" | 3 9/16" | 1/2" | 1 3/8" | 7/32" | 1" |
| 2-7603A | 1/2" NPT | HF4 | 10,000 | 3/32" | 5 1/4" | 2" | 2 1/8" | 3 9/16" | 1/2" | 1 3/8" | 7/32" | 1" |

* Rupture discs must be ordered separately (see section 3.7).



High Pressure Equipment

Block and Bleed Needle Valves

High Pressure Equipment offers Block and Bleed needle valves designed for calibration operations. Block and Bleed needle valves provide controlled flow to high-pressure hydraulic and pneumatic systems through both shut-off regulation and diversion. These needle valves deliver safe, reliable operation to 20,000 psi.* Teflon packing provides dependable leak-free service up to 400°F (204°C).

- Tube sizes: $\frac{1}{4}$ " , $\frac{3}{8}$ " , $\frac{9}{16}$ " medium pressure and $\frac{1}{4}$ " FNPT, $\frac{3}{8}$ " FNPT, $\frac{1}{2}$ " FNPT
- Non-rotating stem design
- Type 300 stainless steel tee handles
- Teflon packing to 400°F (204°C)
- Optional wetted parts available
- Optional O-rings available

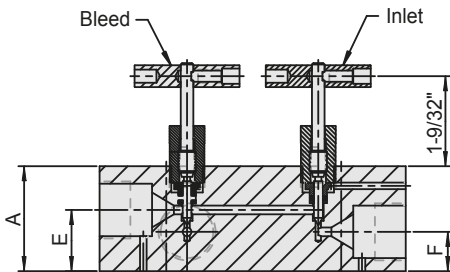
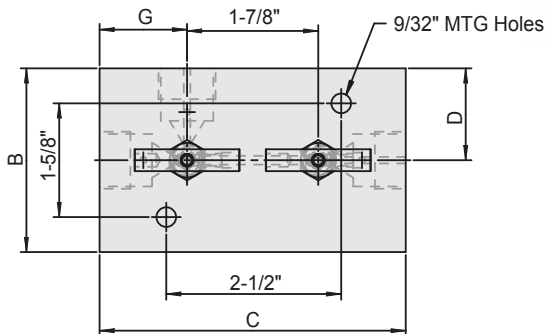

Dimensions in inches

| Catalog Number | Connector | A | B | C | D | E | F | G |
|----------------|---------------------|------------------|------------------|------------------|-------------------|------------------|-------------------|-------------------|
| 15-SBB-NFB | $\frac{1}{4}$ " NPT | $1\frac{1}{2}$ " | $2\frac{5}{8}$ " | $3\frac{7}{8}$ " | $1\frac{5}{16}$ " | $\frac{7}{8}$ " | $\frac{9}{16}$ " | 1" |
| 15-SBB-NFC | $\frac{3}{8}$ " NPT | $1\frac{3}{4}$ " | 3" | $4\frac{3}{8}$ " | $1\frac{1}{2}$ " | $1\frac{1}{8}$ " | $\frac{13}{16}$ " | $1\frac{1}{4}$ " |
| 15-SBB-NFD | $\frac{1}{2}$ " NPT | $1\frac{3}{4}$ " | 3" | $4\frac{3}{8}$ " | $1\frac{1}{2}$ " | $1\frac{1}{8}$ " | $\frac{13}{16}$ " | $1\frac{1}{4}$ " |
| 20-SBB-LF4 | LF4 | $1\frac{1}{2}$ " | $2\frac{5}{8}$ " | $3\frac{1}{2}$ " | $1\frac{5}{16}$ " | $\frac{7}{8}$ " | $\frac{9}{16}$ " | $\frac{13}{16}$ " |
| 20-SBB-LF6 | LF6 | $1\frac{1}{2}$ " | $2\frac{5}{8}$ " | $3\frac{3}{4}$ " | $1\frac{5}{16}$ " | $\frac{7}{8}$ " | $\frac{9}{16}$ " | $\frac{15}{16}$ " |
| 20-SBB-LF9 | LF9 | $1\frac{1}{2}$ " | $2\frac{5}{8}$ " | $4\frac{3}{8}$ " | $1\frac{5}{16}$ " | $\frac{7}{8}$ " | $\frac{9}{16}$ " | $1\frac{1}{4}$ " |

* NPT connection: rated 15,000 psi

Double Block and Bleed Needle Valves

High Pressure Equipment Company introduces its Double Block and Bleed needle valves that deliver safe, reliable operation to 20,000 psi. Our valves feature coned and threaded connections for 1/4" to 1" medium pressure tubing, making them ideal for pressure monitoring and testing, chemical injection and drain line isolation applications. This valve is manufactured from cold worked stainless steel and 17-4-H1075 with 300 stainless steel tee handles and a non-rotating stem design. Teflon packing provides reliable leak-free service from 0°F (-17.8°C) to 400°F (204°C).

- Rated for service to 20,000 psi
- DBB series: 1/4" to 1" medium pressure, coned and threaded connections
- Non-rotating stem design
- Type 300 stainless steel tee handles
- Manufactured from cold worked stainless steel and 17-4-H1075
- 1/4" FNPT vent
- Teflon packing from 0°F (-17.8°C) to 400°F (204°C)
- Optional wetted parts available
- Optional PolyPak available

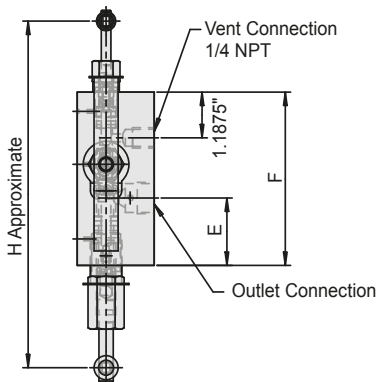
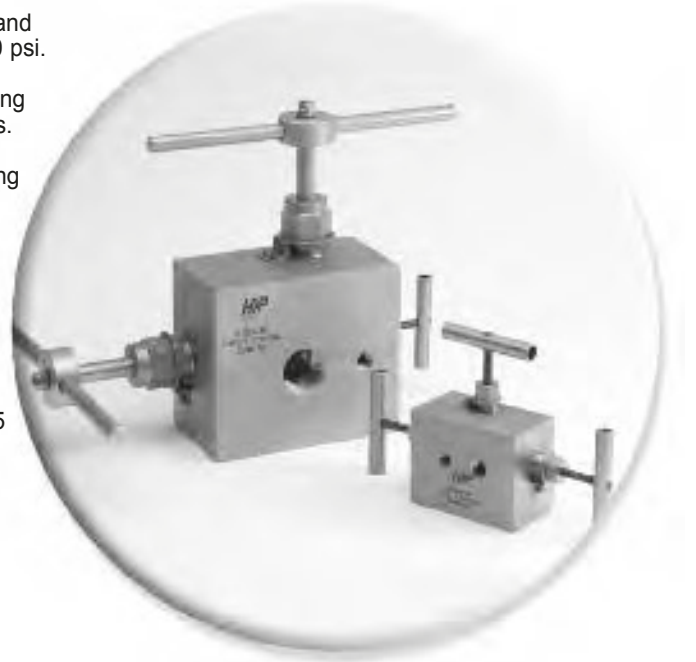

| Catalog Number | Inlet Connector | Outlet Connector | A | B | C | D | E | F | G | H | K |
|----------------|-----------------|------------------|--------|--------|----------|--------|----------|--------|---------|---------|---------|
| 20-DBB-LF4 | LF4 | LF4 | 2" | 1 1/4" | 1 3/16" | 2 3/4" | 1 3/16" | 3 1/2" | 4 5/8" | 7 3/16" | 3" |
| 20-DBB-LF6 | LF6 | LF6 | 2" | 1 1/4" | 1 3/16" | 2 3/4" | 1 3/16" | 3 1/2" | 4 5/8" | 7 3/16" | 3" |
| 20-DBB-LF9 | LF9 | LF9 | 2" | 1 1/4" | 1 3/4" | 3 3/8" | 1 3/4" | 4 1/2" | 6 1/16" | 9" | 4 1/2" |
| 20-DBB-LF12 | LF12 | LF12 | 2 1/2" | 1 3/4" | 2 1/4" | 4 1/4" | 2 1/4" | 5" | 6 7/8" | 9 1/2" | 8 3/4" |
| 20-DBB-LF16 | LF16 | LF16 | 3 1/2" | 2 1/2" | 2 13/16" | 5 1/4" | 2 13/16" | 6" | 8 7/16" | 11" | 10 1/4" |

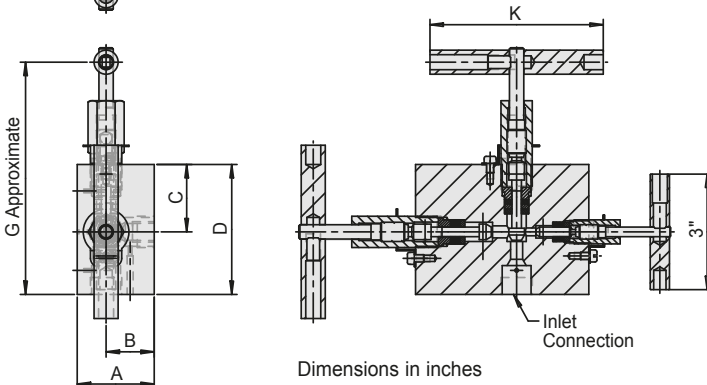



High Pressure Equipment

Subsea Ball Valves

In today's offshore oil and gas industry, wells have become deeper than ever, causing a growing demand for subsea ball valves that can withstand extreme pressures and harshest environments. As a leader in developing ways to provide effective shut off under increasing temperature and pressure requirements at greater depths, High Pressure Equipment offers subsea ball valves that provide safe and reliable operation at very high external pressures.

High Pressure Equipment's Subsea Ball Valves feature their reliable trunion style ball design and incorporate the required design modifications for ideal performance in critical subsea systems. HiP offers the industry's widest range of subsea valve sizes, these valves are available in 2 or 3 way configurations with 180° operation or 90° diverter styles in .187", .375" and .500" orifices and 10, 15 and 20,000 psi pressure ranges.

Subsea Valve Features

- Trunion style ball design
- 316 cold-worked SS construction
- Two and three-way valve configurations
- 90° diverter or 180° styles
- .187", .375" and .500" orifices
- PEEK ball seats, which offers excellent resistance to chemicals, heat and wear/abrasion
- Optional O-rings available
- Optional wetted materials
- Available to NACE MR-01-75



Subsea Ball Valves

.187 Orifice Subsea Ball Valves

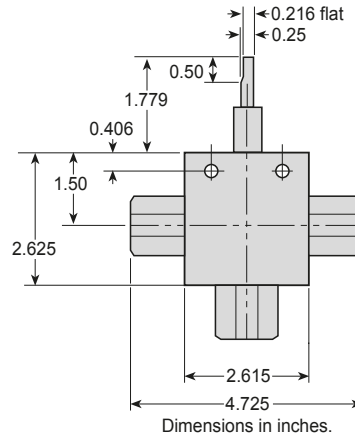

3-Way Ball Valve

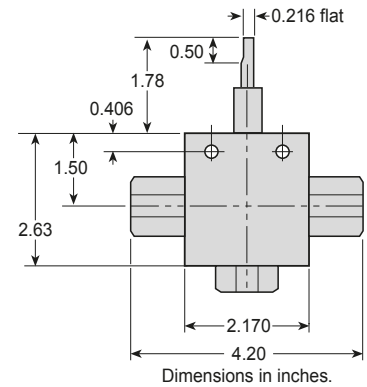

2-Way Ball Valve

| Orifice | Tube Size | Connection | Pressure Rating | Minimum Orifice | C _v | Catalog No. |
|--------------------------|-----------|------------|-----------------|-----------------|----------------|--------------|
| 3-Way 180° | 3/8" | HF6 | 20,000 psi | 0.125 | 0.22 | 20-72HF6-SUB |
| | 1/4" | HF4 | 20,000 psi | 0.094 | 0.10 | 20-72HF4-SUB |
| | 9/16" | LF9 | 20,000 psi | 0.187 | 0.71 | 20-72HF9-SUB |
| | 3/8" | LF6 | 20,000 psi | 0.187 | 0.71 | 20-72LF6-SUB |
| | 1/4" | LF4 | 20,000 psi | 0.109 | 0.15 | 20-72LF4-SUB |
| | 3/8" | 3/8" NPT | 15,000 psi | 0.187 | 0.71 | 15-72NFC-SUB |
| | 1/4" | 1/4" NPT | 15,000 psi | 0.187 | 0.71 | 15-72NFB-SUB |
| 3-Way 90° Diverter | 3/8" | HF6 | 20,000 psi | 0.125 | 0.22 | 20-73HF6-SUB |
| | 1/4" | HF4 | 20,000 psi | 0.094 | 0.10 | 20-73HF4-SUB |
| | 9/16" | LF9 | 20,000 psi | 0.187 | 0.71 | 20-73LF9-SUB |
| | 3/8" | LF6 | 20,000 psi | 0.187 | 0.71 | 20-73LF6-SUB |
| | 1/4" | LF4 | 20,000 psi | 0.109 | 0.15 | 20-73LF4-SUB |
| | 3/8" | 3/8" NPT | 15,000 psi | 0.187 | 0.71 | 15-73NFC-SUB |
| | 1/4" | 1/4" NPT | 15,000 psi | 0.187 | 0.71 | 15-73NFB-SUB |
| 2-Way | 9/16" | HF9 | 20,000 psi | 0.187 | 1.45 | 20-71HF9-SUB |
| | 3/8" | HF6 | 20,000 psi | 0.125 | 0.45 | 20-71HF6-SUB |
| | 1/4" | HF4 | 20,000 psi | 0.094 | 0.20 | 20-71HF4-SUB |
| | 9/16" | LF9 | 20,000 psi | 0.187 | 1.45 | 20-71LF9-SUB |
| | 3/8" | LF6 | 20,000 psi | 0.187 | 1.45 | 20-71LF6-SUB |
| | 1/4" | LF4 | 20,000 psi | 0.109 | 0.31 | 20-71LF4-SUB |
| | 1/2" | 1/2" NPT | 15,000 psi | 0.187 | 1.45 | 15-71NFD-SUB |
| | 3/8" | 3/8" NPT | 15,000 psi | 0.187 | 1.45 | 15-71NFC-SUB |
| | 1/4" | 1/4" NPT | 15,000 psi | 0.187 | 1.45 | 15-71NFB-SUB |
| 1/8" | 1/8" NPT | 15,000 psi | 0.187 | 1.45 | 15-71NFA-SUB | |

.375 Orifice Subsea Ball Valves

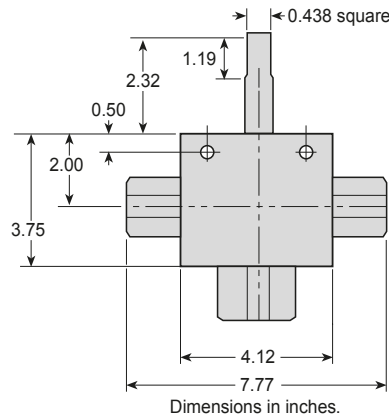

3-Way Ball Valve

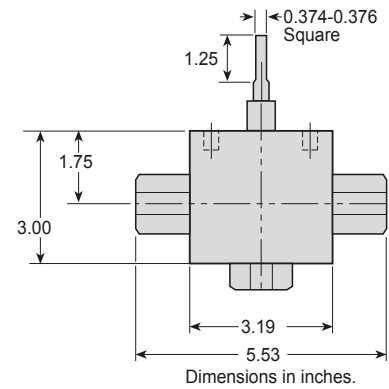

2-Way Ball Valve

| Orifice | Tube Size | Connection | Pressure Rating | Minimum Orifice | C _v | Catalog No. |
|--------------------------|-----------|------------|-----------------|-----------------|----------------|---------------|
| 3-Way 180° | 3/4" | LF12 | 15,000 psi | 0.375 | 2.40 | 15-75LF12-SUB |
| | 9/16" | LF9 | 15,000 psi | 0.312 | 1.67 | 15-75LF9-SUB |
| | 3/8" | LF6 | 15,000 psi | 0.203 | 0.81 | 15-75LF6-SUB |
| | 1/2" | 1/2" NPT | 15,000 psi | 0.375 | 2.40 | 15-75NFD-SUB |
| | 3/8" | 3/8" NPT | 15,000 psi | 0.375 | 2.40 | 15-75NFC-SUB |
| | 1/4" | 1/4" NPT | 15,000 psi | 0.250 | 1.07 | 15-75NFB-SUB |
| 3-Way 90° Diverter | 3/4" | LF12 | 15,000 psi | 0.375 | 2.40 | 15-76LF12-SUB |
| | 9/16" | LF9 | 15,000 psi | 0.312 | 1.67 | 15-76LF9-SUB |
| | 3/8" | LF6 | 15,000 psi | 0.203 | 0.81 | 15-76LF6-SUB |
| | 1/2" | 1/2" NPT | 15,000 psi | 0.375 | 2.40 | 15-76NFD-SUB |
| | 3/8" | 3/8" NPT | 15,000 psi | 0.375 | 2.40 | 15-76NFC-SUB |
| | 1/4" | 1/4" NPT | 15,000 psi | 0.250 | 1.07 | 15-76NFB-SUB |
| 2-Way | 3/4" | LF12 | 15,000 psi | 0.375 | 6.08 | 15-74LF12-SUB |
| | 9/16" | LF9 | 15,000 psi | 0.312 | 4.22 | 15-74LF9-SUB |
| | 3/8" | LF6 | 15,000 psi | 0.203 | 2.20 | 15-74LF6-SUB |
| | 1/2" | 1/2" NPT | 15,000 psi | 0.375 | 6.08 | 15-74NFD-SUB |
| | 3/8" | 3/8" NPT | 15,000 psi | 0.375 | 6.08 | 15-74NFC-SUB |
| | 1/4" | 1/4" NPT | 15,000 psi | 0.250 | 2.70 | 15-74NFB-SUB |

.500 Orifice Subsea Ball Valves

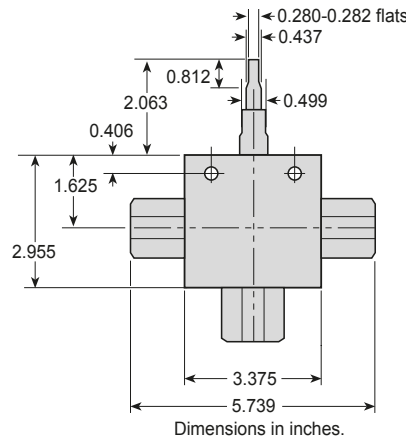

3-Way Ball Valve

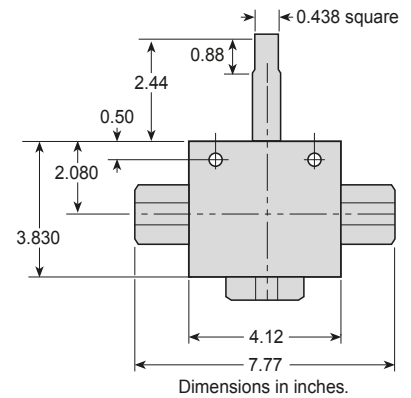

2-Way Ball Valve

| Orifice | Tube Size | Connection | Pressure Rating | Minimum Orifice | C _v | Catalog No. |
|--------------------------|-----------|------------|-----------------|-----------------|----------------|---------------|
| 3-Way 180° | 1" | 1" NPT | 10,000 psi | .500 | 4.40 | 10-81NFH-SUB |
| | 3/4" | 3/4" NPT | 10,000 psi | .500 | 4.40 | 10-81NFF-SUB |
| | 1" | LF16 | 10,000 psi | .500 | 4.40 | 10-81LF16-SUB |
| | 3/4" | LF12 | 10,000 psi | .500 | 4.40 | 10-81LF12-SUB |
| 3-Way 90° Diverter | 1" | 1" NPT | 10,000 psi | .500 | 4.40 | 10-82NFH-SUB |
| | 3/4" | 3/4" NPT | 10,000 psi | .500 | 4.40 | 10-82NFF-SUB |
| | 1" | LF16 | 10,000 psi | .500 | 4.40 | 10-82LF16-SUB |
| | 3/4" | LF12 | 10,000 psi | .500 | 4.40 | 10-82LF12-SUB |
| 2-Way | 1" | 1" NPT | 10,000 psi | .500 | 10.2 | 10-80NFH-SUB |
| | 3/4" | 3/4" NPT | 10,000 psi | .500 | 10.2 | 10-80NFF-SUB |
| | 1" | LF16 | 10,000 psi | .500 | 10.2 | 10-80LF16-SUB |
| | 3/4" | LF12 | 10,000 psi | .500 | 10.2 | 10-80LF12-SUB |

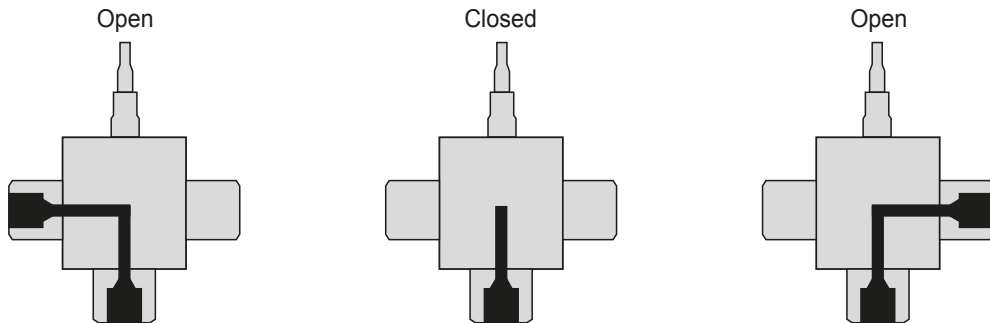

180° Three-Way Ball Valve

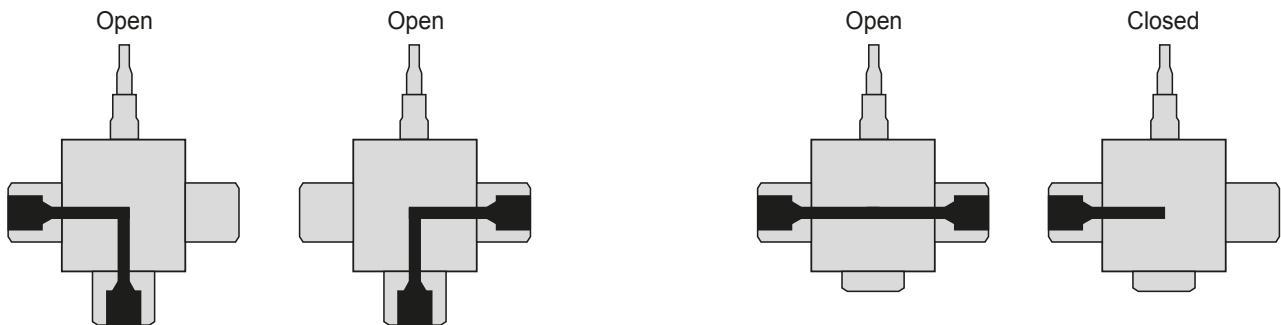

90° Three-Way Diverter Valve

Two-Way Valve



High Pressure Equipment

Air Operated Valves

High Pressure Equipment Company offers five lines of air operators to accommodate remote operation of pressure valves up to 100,000 psi. Various models of diaphragm and piston operated valves are available in both normally open and normally closed models, and can be controlled by air regulator, electrical solenoid or low pressure manual valve. The Remetco line of air operated metering valves provides remote operation for fine metering applications.



| Index | Page |
|---------------------------------------------------------------|-------|
| Mini-Hippo Piston Air Operators | 7.1.5 |
| Hipco Diaphragm Air Operators | 7.2 |
| Remarco Diaphragm Air Operators | 7.3 |
| Hippo Piston Air Operators | 7.3.5 |
| Remetco Piston Air Operated Fine Metering Valves | 7.4 |



High Pressure Equipment

Mini-Hippo Piston Air Operators for Remote Operation To 6,000 psi

Mini-Hippo Air Operators are available for both normally open service (spring to open/air to close) and for normally closed service (air to open/spring to close). These piston operators provide remote automatic on/off operation of valves and can be controlled by means of an air regulator, an electrical solenoid, or a manual low pressure valve in the user's air supply line. Air inlet is 1/8" NPT. Air pressure requirement ranges from 50 to 90 psi.

The Mini-Hippo air operators may be supplied with the valves and operating pressures shown in table.

To order simply specify catalog number of valve and type operation required.

EXAMPLES: Mini-Hippo 30-11HF4 (normally closed)
Mini-Hippo 10-12AF6 (normally open)
Mini-Hippo 10-15AF4 (normally open/
normally closed)

3" Diameter
Piston Air
Operators



Normally
Open



Normally
Closed

Normally Open (Spring To Open / Air To Close)

| Valve Series | Maximum Operating Pressure | Approximate Air Pressure to Seat Valve |
|--------------|----------------------------|----------------------------------------|
| 10-**AF2 | 6,000 psi | 55 psi |
| 10-**AF4 | 6,000 psi | 55 psi |
| 10-**AF6 | 6,000 psi | 55 psi |
| 30-**HF4 | 6,000 psi | 55 psi |
| 30-**HF6 | 6,000 psi | 55 psi |
| 30-**HF9 | 6,000 psi | 55 psi |

Normally Closed (Air To Open / Spring To Close)

| Valve Series | Maximum Operating Pressure | Minimum Adjusting Screw Torque | Approximate Air Pressure to Unseat Valve | Approximate Air Pressure to Fully Open Valve |
|--------------|----------------------------|--------------------------------|------------------------------------------|----------------------------------------------|
| 10-**AF4 | 6,000 psi | 15 in. lb. | 50 psi | 90 psi |
| 10-**AF6 | 6,000 psi | 15 in. lb. | 50 psi | 90 psi |
| 30-**HF4 | 6,000 psi | 15 in. lb. | 50 psi | 90 psi |
| 30-**HF6 | 6,000 psi | 15 in. lb. | 50 psi | 90 psi |
| 30-**HF9 | 6,000 psi | 15 in. lb. | 50 psi | 90 psi |

** Standard Valve Patterns (reference Page 1.4)

OPTIONS: *Stems & Seats* . . . Carbide (for cyclic service)
Stellite (for cyclic service)
17-4 (for cyclic service)

Valve Bodies Hastelloy C, Hastelloy B
Inconel 600, Inconel 625
Incoloy 800, Incoloy 825
Titanium Grade 2, Titanium 6AL4V
Nickel
Monel

Packing PolyPak

Temperature

Considerations . . . Extended stuffing box for temperatures from -423°F to 1,200°F (medium and high pressure connections only)

Air Operated Valves

Hipco Diaphragm Air Operators for Remote Operation To 60,000 psi

Hipco Air Operators are available for both normally open service (spring to open/air to close) and for normally closed service (air to open/spring to close). These diaphragm air operators provide remote automatic on/off operation of valves and can be controlled by means of an air regulator, an electrical solenoid, or a manual low pressure valve in the user's air supply line. Air inlet is 1/4" NPT.

The Hipco air operators may be supplied with the valves and operating pressures shown in table.

To order simply specify catalog number of valve and type operation required.

EXAMPLES: Hipco 30-11HF4 (normally closed)
 Hipco 10-12NFB (normally open)
 Hipco 10-15AF4 (normally open/normally closed)

OPTIONS: *Stems & Seats* . . . Carbide (for cyclic service)
 Stellite (for cyclic service)
 17-4 (for cyclic service)

Valve Bodies . . . Hastelloy C, Hastelloy B
 Inconel 600, Inconel 625
 Incoloy 800, Incoloy 825
 Titanium Grade 2,
 Titanium 6AL4V
 Nickel
 Monel

Packing PolyPak

Temperature

Considerations . . . Extended stuffing box for temperatures from -423°F to 1,200°F (medium and high pressure connections only)

6 7/8" Diameter Diaphragm Air Operators



Normally Open (Spring To Open / Air To Close)

| Valve Series | Maximum Operating Pressure | Approximate Air Pressure to Seat Valve |
|--------------|----------------------------|----------------------------------------|
| 10-**AF4 | 10,000 psi | 35 psi |
| 10-**AF6 | 10,000 psi | 35 psi |
| 10-**NFA | 10,000 psi | 35 psi |
| 10-**NFB | 10,000 psi | 35 psi |
| 10-**NFC | 10,000 psi | 35 psi |
| 15F-**NFA | 15,000 psi | 85 psi |
| 15F-**NFB | 15,000 psi | 85 psi |
| 15F-**NFC | 10,000 psi | 100 psi |
| 15F-**NFD | 10,000 psi | 100 psi |
| 20-**LF4 | 20,000 psi | 60 psi |
| 20-**LF6 | 15,000 psi | 85 psi |
| 20-**LF9 | 10,000 psi | 100 psi |
| 30-**HF4 | 30,000 psi | 60 psi |
| 30-**HF6 | 30,000 psi | 85 psi |
| 30-**HF9 | 30,000 psi | 85 psi |
| 40-**HF9 | 30,000 psi | 85 psi |
| 60-**HF4 | 60,000 psi | 70 psi |
| 60-**HF6 | 60,000 psi | 70 psi |
| 60-**HF9 | 60,000 psi | 70 psi |

Normally Closed (Air To Open / Spring To Close)

| Valve Series | Maximum Operating Pressure | Minimum Adjusting Screw Torque | Approximate Air Pressure to Unseat Valve | Approximate Air Pressure to Fully Open Valve |
|--------------|----------------------------|--------------------------------|------------------------------------------|----------------------------------------------|
| 10-**AF4 | 10,000 psi | 20 in. lb. | 30 psi | 45 psi |
| 10-**AF6 | 10,000 psi | 20 in. lb. | 30 psi | 45 psi |
| 10-**NFA | 10,000 psi | 20 in. lb. | 30 psi | 45 psi |
| 10-**NFB | 10,000 psi | 20 in. lb. | 30 psi | 45 psi |
| 10-**NFC | 10,000 psi | 20 in. lb. | 30 psi | 45 psi |
| 15F-**NFA | 15,000 psi | 60 in. lb. | 80 psi | 100 psi |
| 15F-**NFB | 15,000 psi | 60 in. lb. | 80 psi | 100 psi |
| 15F-**NFC | 10,000 psi | 75 in. lb. | 95 psi | 100 psi |
| 15F-**NFD | 10,000 psi | 75 in. lb. | 95 psi | 100 psi |
| 20-**LF4 | 20,000 psi | 40 in. lb. | 55 psi | 90 psi |
| 20-**LF6 | 15,000 psi | 60 in. lb. | 80 psi | 100 psi |
| 20-**LF9 | 10,000 psi | 75 in. lb. | 95 psi | 100 psi |
| 30-**HF4 | 30,000 psi | 40 in. lb. | 55 psi | 75 psi |
| 30-**HF6 | 30,000 psi | 60 in. lb. | 80 psi | 100 psi |
| 30-**HF9 | 30,000 psi | 60 in. lb. | 80 psi | 100 psi |
| 40-**HF9 | 30,000 psi | 60 in. lb. | 80 psi | 100 psi |
| 60-**HF4 | 60,000 psi | 50 in. lb. | 65 psi | 85 psi |
| 60-**HF6 | 60,000 psi | 50 in. lb. | 65 psi | 85 psi |
| 60-**HF9 | 60,000 psi | 50 in. lb. | 65 psi | 85 psi |

** Standard Valve Patterns (reference Page 1.4)



High Pressure Equipment

Remarco Diaphragm Operated Valves for Remote Operation

To 100,000 psi

Remarco air operated valves are available for both normally open service (spring to open/air to close) and for normally closed service (air to open/spring to close). These diaphragm operated valves provide remote operation up to 100,000 psi by means of an air input supply ranging from 25 to 90 psi to the air actuator.

An electrical solenoid valve for the air supply is provided with all Remarco valves and is mounted directly to the valve. The standard solenoid is 120 volt, 60 cycle, 11 watts with 1/8" NPT air inlet. (Other voltages available at additional charge—consult factory). The solenoid is normally closed and when energized allows air into the diaphragm casing to activate the valve. In the event of an electrical or air line failure, the valve will return to its "normal" position.

The Remarco valve features removable stem seats. Valve bodies are 316 stainless steel. Valve stems are hardened 17-4PH stainless steel up to 60,000 psi. Tool steel stems are standard on 100,000 psi valves. Standard packing on the 30,000 psi and 60,000 psi Remarco valves is Teflon O-ring with Buna-N, Viton, or Silicone, available at no additional cost.

9 7/8" Diameter Diaphragm Air Operators



Normally Open (Spring To Open / Air To Close)

| Valve Series | Maximum Operating Pressure | Approximate Air Pressure to Seat Valve | Orifice | Connections | Tubing Size | |
|--------------|----------------------------|----------------------------------------|---------|-------------|-------------|-------|
| | | | | | O.D. | I.D. |
| D10R12LF9R | 10,000 psi | 60 psi | 1/4" | LF9 | 9/16" | 5/16" |
| D20R12LF9R | 20,000 psi | 75 psi | 1/4" | LF9 | 9/16" | 5/16" |
| D30R12HF4R | 30,000 psi | 65 psi | 1/8" | HF4 | 1/4" | .083" |
| D30R12HF6R | 30,000 psi | 65 psi | 1/8" | HF6 | 3/8" | 1/8" |
| D30R12HF9R | 30,000 psi | 65 psi | 1/8" | HF9 | 9/16" | 3/16" |
| D10R12HF9R | 10,000 psi | 60 psi | 1/4" | HF9 | 9/16" | 5/16" |
| D60R12HF4R | 60,000 psi | 55 psi | 1/16" | HF4 | 1/4" | 1/16" |
| D60R12HF6R | 60,000 psi | 55 psi | 1/16" | HF6 | 3/8" | 1/8" |
| D60R12HF9R | 60,000 psi | 55 psi | 1/16" | HF9 | 9/16" | 3/16" |
| D100R12XF4R | 100,000 psi | 90 psi | 1/16" | XF4 | 1/4" | 1/16" |
| D100R12XF6R | 100,000 psi | 90 psi | 1/16" | XF6 | 3/8" | 1/16" |

Normally Closed (Air To Open / Spring To Close)

| Valve Series | Maximum Operating Pressure | Lock Nut Torque Setting | Approximate Air Pressure to Unseat Valve | Approximate Air Pressure to Fully Open Valve | Orifice | Connections | Tubing Size | |
|--------------|----------------------------|-------------------------|------------------------------------------|----------------------------------------------|---------|-------------|-------------|-------|
| | | | | | | | O.D. | I.D. |
| SD10R12LF9R | 10,000 psi | 20 ft. lb. | 55 psi | 90 psi | 1/4" | LF9 | 9/16" | 5/16" |
| SD20R12LF9R | 20,000 psi | 40 ft. lb. | 70 psi | 90 psi | 1/4" | LF9 | 9/16" | 5/16" |
| SD30R12HF4R | 30,000 psi | 20 ft. lb. | 60 psi | 75 psi | 1/8" | HF4 | 1/4" | .083" |
| SD30R12HF6R | 30,000 psi | 20 ft. lb. | 60 psi | 75 psi | 1/8" | HF6 | 3/8" | 1/8" |
| SD30R12HF9R | 30,000 psi | 20 ft. lb. | 60 psi | 75 psi | 1/8" | HF9 | 9/16" | 3/16" |
| SD10R12HF9R | 10,000 psi | 20 ft. lb. | 55 psi | 90 psi | 1/4" | HF9 | 9/16" | 5/16" |
| SD60R12HF4R | 60,000 psi | 20 ft. lb. | 50 psi | 65 psi | 1/16" | HF4 | 1/4" | 1/16" |
| SD60R12HF6R | 60,000 psi | 20 ft. lb. | 50 psi | 65 psi | 1/16" | HF6 | 3/8" | 1/8" |
| SD60R12HF9R | 60,000 psi | 20 ft. lb. | 50 psi | 65 psi | 1/16" | HF9 | 9/16" | 3/16" |
| SD100R12XF4R | 100,000 psi | 30 ft. lb. | 85 psi | 100 psi | 1/16" | XF4 | 1/4" | 1/16" |
| SD100R12XF6R | 100,000 psi | 30 ft. lb. | 85 psi | 100 psi | 1/16" | XF6 | 3/8" | 1/16" |

- OPTIONS: Stems & Seats . . . Carbide (for cyclic service)
Stellite (for cyclic service)
- Valve Bodies MP35N – water service 100K valve
Hastelloy C, Hastelloy B
Inconel 600, Inconel 625
Incoloy 800, Incoloy 825
Titanium Grade 2, Titanium 6AL4V
Nickel, Monel
- Packing PolyPak



Air Operated Valves

Hippo Piston Air Operators for Remote Operation To 60,000 psi

Hippo Piston Air Operators are available for both normally open service (spring to open/air to close) and for normally closed service (air to open/spring to close). These piston air operators provide remote automatic on/off operation of valves and can be controlled by means of an air regulator, an electrical solenoid, or a manual low pressure valve in the user's air supply line. Air inlet is 1/8" NPT. Air pressure requirement ranges from 35 psi to 120 psi.

These operators may be supplied with the valves and operating pressures shown in table.

Normally Closed (Air To Open/Spring To Close)

Medium Duty

| Valve Series | Maximum Operating Pressure | Orifice Size | Minimum Adjusting Screw Torque | Approximate Air Pressure to Unseat Valve | Approximate Air Pressure to Fully Open | Part Number Suffix |
|--------------|----------------------------|--------------|--------------------------------|------------------------------------------|----------------------------------------|--------------------|
| 10-**AF4 | 10,000 psi | 1/8" | 25 in.lb. | 30 psi | 40 psi | MPO-NC |
| 10-**AF6 | 10,000 psi | 1/8" | 25 in.lb. | 30 psi | 40 psi | MPO-NC |
| 15F-**NFA | 15,000 psi | 13/64" | 45 in.lb. | 55 psi | 75 psi | MPO-NC |
| 15F-**NFB | 15,000 psi | 13/64" | 45 in.lb. | 55 psi | 75 psi | MPO-NC |
| 15F-**NFC | 10,000 psi | 5/16" | 55 in.lb. | 70 psi | 95 psi | MPO-NC |
| 15F-**NFD | 10,000 psi | 5/16" | 55 in.lb. | 70 psi | 95 psi | MPO-NC |
| 20-**LF4 | 20,000 psi | 1/8" | 50 in.lb. | 70 psi | 95 psi | MPO-NC |
| 20-**LF6 | 20,000 psi | 13/64" | 55 in.lb. | 70 psi | 95 psi | MPO-NC |
| 20-**LF9 | 10,000 psi | 5/16" | 55 in.lb. | 70 psi | 95 psi | MPO-NC |
| 30-**HF4 | 30,000 psi | 3/32" | 50 in.lb. | 60 psi | 75 psi | MPO-NC |
| 30-**HF6 | 30,000 psi | 1/8" | 55 in.lb. | 60 psi | 75 psi | MPO-NC |
| 30-**HF9 | 30,000 psi | 1/8" | 55 in.lb. | 60 psi | 75 psi | MPO-NC |
| 60-**HF4 | 60,000 psi | 1/16" | 50 in.lb. | 50 psi | 65 psi | MPO-NC |
| 60-**HF6 | 60,000 psi | 1/16" | 50 in.lb. | 50 psi | 65 psi | MPO-NC |
| 60-**HF9 | 60,000 psi | 1/16" | 50 in.lb. | 50 psi | 65 psi | MPO-NC |

Heavy Duty

| | | | | | | |
|-----------|------------|--------|-----------|--------|--------|--------|
| 15F-**NFC | 15,000 psi | 5/16" | 85 in.lb. | 60 psi | 75 psi | HPO-NC |
| 15F-**NFD | 15,000 psi | 5/16" | 85 in.lb. | 60 psi | 75 psi | HPO-NC |
| 20-**LF4 | 20,000 psi | 1/8" | 55 in.lb. | 35 psi | 50 psi | HPO-NC |
| 20-**LF6 | 20,000 psi | 13/64" | 60 in.lb. | 35 psi | 50 psi | HPO-NC |
| 20-**LF9 | 16,000 psi | 5/16" | 85 in.lb. | 60 psi | 75 psi | HPO-NC |
| 20-**LF12 | 9,000 psi | 7/16" | 85 in.lb. | 60 psi | 75 psi | HPO-NC |
| 20-**LF16 | 6,000 psi | 9/16" | 85 in.lb. | 60 psi | 75 psi | HPO-NC |
| 30-**HF4 | 30,000 psi | 3/32" | 50 in.lb. | 30 psi | 40 psi | HPO-NC |
| 30-**HF6 | 30,000 psi | 1/8" | 55 in.lb. | 30 psi | 40 psi | HPO-NC |
| 30-**HF9 | 30,000 psi | 1/8" | 55 in.lb. | 30 psi | 40 psi | HPO-NC |
| 60-**HF4 | 60,000 psi | 1/16" | 50 in.lb. | 25 psi | 35 psi | HPO-NC |
| 60-**HF6 | 60,000 psi | 1/16" | 50 in.lb. | 25 psi | 35 psi | HPO-NC |
| 60-**HF9 | 60,000 psi | 1/16" | 50 in.lb. | 25 psi | 35 psi | HPO-NC |

Extra Heavy Duty

| | | | | | | |
|-----------|------------|--------|-----------|--------|--------|---------|
| 20-**LF12 | 20,000 psi | 7/16" | 60 ft.lb. | 35 psi | 60 psi | EHPO-NC |
| 10-**NFF | 10,000 psi | 11/16" | 75 ft.lb. | 45 psi | 70 psi | EHPO-NC |
| 10-**NFH | 10,000 psi | 11/16" | 75 ft.lb. | 45 psi | 70 psi | EHPO-NC |
| 10-**LF16 | 10,000 psi | 11/16" | 75 ft.lb. | 45 psi | 70 psi | EHPO-NC |
| 20-**LF16 | 20,000 psi | 9/16" | 95 ft.lb. | 55 psi | 95 psi | EHPO-NC |
| 30-**HF16 | 30,000 psi | 7/16" | 90 ft.lb. | 50 psi | 85 psi | EHPO-NC |

To order simply specify catalog number of valve and appropriate suffix of operator required.

EXAMPLES: Hippo 20-11LF4-MPO-NC (normally closed)
Hippo 20-12LF6-HPO-NO (normally open)

OPTIONS:

Stems & Seat . . . Carbide, ceramic or Stellite (for cyclic service)

Valve Bodies . . . Hastelloy C, Hastelloy B
Inconel 600, Inconel 625
Incoloy 800, Incoloy 825
Titanium Grade 2, Titanium 6AL4V
Nickel
Monel

Packing PolyPak

Temperature

Consideration . . . Extended stuffing box for temperatures from -423°F to 1,200°F (medium and high pressure connections only)

Normally Open (Spring To Open / Air To Close)

Medium Duty

| Valve Series | Maximum Operating Pressure | Orifice Size | Approximate Air Pressure to Seat Valve | Part Number Suffix |
|--------------|----------------------------|--------------|----------------------------------------|--------------------|
| 10-**AF4 | 10,000 psi | 1/8" | 35 psi | MPO-NO |
| 10-**AF6 | 10,000 psi | 1/8" | 35 psi | MPO-NO |
| 15F-**NFA | 15,000 psi | 13/64" | 75 psi | MPO-NO |
| 15F-**NFB | 15,000 psi | 13/64" | 75 psi | MPO-NO |
| 15F-**NFC | 10,000 psi | 5/16" | 100 psi | MPO-NO |
| 15F-**NFD | 10,000 psi | 5/16" | 100 psi | MPO-NO |
| 20-**LF4 | 20,000 psi | 1/8" | 95 psi | MPO-NO |
| 20-**LF6 | 20,000 psi | 13/64" | 100 psi | MPO-NO |
| 20-**LF9 | 10,000 psi | 5/16" | 100 psi | MPO-NO |
| 20-**LF12 | 6,000 psi | 7/16" | 100 psi | MPO-NO |
| 30-**HF4 | 30,000 psi | 3/32" | 60 psi | MPO-NO |
| 30-**HF6 | 30,000 psi | 1/8" | 60 psi | MPO-NO |
| 30-**HF9 | 30,000 psi | 1/8" | 60 psi | MPO-NO |
| 60-**HF4 | 60,000 psi | 1/16" | 55 psi | MPO-NO |
| 60-**HF6 | 60,000 psi | 1/16" | 55 psi | MPO-NO |
| 60-**HF9 | 60,000 psi | 1/16" | 55 psi | MPO-NO |

Heavy Duty

| | | | | |
|-----------|------------|--------|---------|--------|
| 15F-**NFC | 15,000 psi | 5/16" | 75 psi | HPO-NO |
| 15F-**NFD | 15,000 psi | 5/16" | 75 psi | HPO-NO |
| 20-**LF4 | 20,000 psi | 1/8" | 55 psi | HPO-NO |
| 20-**LF6 | 20,000 psi | 13/64" | 55 psi | HPO-NO |
| 20-**LF9 | 20,000 psi | 5/16" | 95 psi | HPO-NO |
| 20-**LF12 | 13,000 psi | 7/16" | 100 psi | HPO-NO |
| 20-**LF16 | 8,800 psi | 9/16" | 100 psi | HPO-NO |
| 30-**HF4 | 30,000 psi | 3/32" | 35 psi | HPO-NO |
| 30-**HF6 | 30,000 psi | 1/8" | 35 psi | HPO-NO |
| 30-**HF9 | 30,000 psi | 1/8" | 35 psi | HPO-NO |
| 60-**HF4 | 60,000 psi | 1/16" | 30 psi | HPO-NO |
| 60-**HF6 | 60,000 psi | 1/16" | 30 psi | HPO-NO |
| 60-**HF9 | 60,000 psi | 1/16" | 30 psi | HPO-NO |

Extra Heavy Duty

| | | | | |
|-----------|------------|--------|--------|---------|
| 20-**LF12 | 20,000 psi | 7/16" | 55 psi | EHPO-NO |
| 10-**NFF | 10,000 psi | 11/16" | 45 psi | EHPO-NO |
| 10-**NFH | 10,000 psi | 11/16" | 45 psi | EHPO-NO |
| 10-**LF16 | 10,000 psi | 11/16" | 45 psi | EHPO-NO |
| 20-**LF16 | 20,000 psi | 9/16" | 55 psi | EHPO-NO |
| 30-**LF16 | 30,000 psi | 7/16" | 50 psi | EHPO-NO |

** Standard Valve Patterns (reference Page 1.4)



High Pressure Equipment

Remetco Piston Operated Fine Metering Valves For Liquids or Gases

Precise control with fast response is possible in fine metering applications to 60,000 psi with Remetco Valves. Pinpoint accuracy and repeatability are assured by a unique stem travel control device working in concert with a Conoflow operator, which is actuated by an input air pressure on only 15 psi.

Body material is Type 316 stainless steel, with both stem and removable seat of 17-4PH. The stem tip is ground to a 9° included taper, with orifice sizes as listed in the ordering table.

Installation requires only connection to an air supply of 20 to 100 psi. This is connected both to the supply air connection and to the instrument air inlet. The latter is regulated between 3 and 15 psi to actuate the valve to the desired position.

Regulation is effected by the user's instrument or by the optional instrument panel at lower left. Thus the valve is in its full open position with a 3 psi air input and in the closed position with a 15 psi air input.

Failsafe operation. In standard configuration, the valve OPENS upon failure of the air supply. It may also be supplied to close upon air failure, to open upon an increase in air signal, or any combination of these specifications.

Remote Valve Positioner "RVP" Optional instrument panel shown at bottom can be ordered as an accessory. It is a manually operated remote air signal valve positioner which permits positioning the stem at any desired point within the 1 1/8" travel of the stem. The dial indicator is graduated into 100 increments; thus each dial increment moves the stem 0.0112".

Standard inlet and outlet connections to the Remetco Valve are for 9/16" OD coned and threaded tubing. Adapters may be supplied for other tubing sizes upon request.

Shutoff not recommended. While this valve is capable of on-off operation, it is designed as a fine metering instrument. To assure maximum stem life, a manual on-off valve should be used in the line upstream of the Remetco Valve.

To order, use assembly number in table and specify if operation is to be other than the standard closure upon air failure. Add "RVP" as suffix if remote air signal valve positioner is desired.

Ordering Table

| Assembly Number | Pressure Rating | Orifice Size | CV |
|-----------------|-----------------|--------------|------|
| 10M-12HF9R | 10,000 psi | 1/4" | 1.2 |
| 30M-12HF9R | 30,000 psi | 1/8" | 0.22 |
| 60M-12HF9R | 60,000 psi | 1/16" | 0.6 |

- OPTIONS: *Stems & Seats* . . . Carbide (for cyclic service)
 Stellite (for cyclic service)
- Valve Bodies* Hastelloy-C, Hastelloy B
 Inconel 600, Inconel 625
 Incoloy 800, Incoloy 825
 Titanium Grade 2, Titanium GAL4V
 Nickel
 Monel
- Packing* PolyPak



Remote Valve Stem Positioner "RVP" above permits remote positioning of valve stem in increments of 0.0112". To order, add suffix "RVP" to base order number.



High Pressure Equipment

Accessories

High Pressure Equipment Company offers an extensive selection of accessory components to enable you to completely plumb a fluid system. These accessories allow you to move from tube to tube, tube to pipe, facilitate system pressure changes and monitor the temperatures and pressures within your system.

Adapters are available in both female to male and male to male configurations. Adapter models exist for all HiP connections and in the various pressure ranges to complement our valve and fitting lines.

Couplings enable you to make a wide variety of female to female connections. As with our adapters, couplings accommodate our complete line of valves and fittings. In addition, reducer couplings allow you to reduce line size within a given pressure range.

Thermocouple adapters are an excellent method to provide for temperature measurement in pressure systems up to 15,000 psi.

Pressure gauges are available in seven models to monitor system pressures ranging from atmosphere to 100,000 psi.



Index

Page

Selection Guide:

- Female to Female Couplings . . .8.2-8.3
- Female to Male Adapters8.4-8.5
- Male to Male Adapters8.6-8.7

Adapters:

- Female to Male8.8-8.14

Adapters:

- Male to Male8.15-8.18

Fittings:

- NPT8.18.1-8.18.2
- Hose8.18.3-8.18.4

Couplings:

- Female to Female8.19-8.23

Thermocouple Adapters8.24

Pressure Gauges8.25



High Pressure Equipment

Female to Female

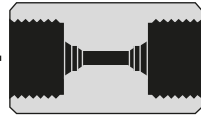

| | | AF1 | AF2 | AF4 | AF6 |
|--------------------------|------|------------------|-----------------|-----------------|-----------------|
| | | 1/16" Taper Seal | 1/8" Taper Seal | 1/4" Taper Seal | 3/8" Taper Seal |
| 1/16" TAPER SEAL | AF1 | 15-21AF1 | 15-21AF1AF2 | 10-21AF1AF4 | 10-21AF1AF6 |
| 1/8" TAPER SEAL | AF2 | 15-21AF1AF2 | 15-21AF2 | 10-21AF2AF4 | 10-21AF2AF6 |
| 1/4" TAPER SEAL | AF4 | 10-21AF1AF4 | 10-21AF2AF4 | 10-21AF4 | 10-21AF4AF6 |
| 3/8" TAPER SEAL | AF6 | 10-21AF1AF6 | 10-21AF2AF6 | 10-21AF4AF6 | 10-21AF6 |
| 1/4" MEDIUM PRESSURE | LF4 | 15-21AF1LF4 | 15-21AF2LF4 | 10-21AF4LF4 | 10-21AF6LF4 |
| 3/8" MEDIUM PRESSURE | LF6 | 15-21AF1LF6 | 15-21AF2LF6 | 10-21AF4LF6 | 10-21AF6LF6 |
| 9/16" MEDIUM PRESSURE | LF9 | 15-21AF1LF9 | 15-21AF2LF9 | 10-21AF4LF9 | 10-21AF6LF9 |
| 3/4" MEDIUM PRESSURE | LF12 | 15-21AF1LF12 | 15-21AF2LF12 | 10-21AF4LF12 | 10-21AF6LF12 |
| 1" MEDIUM PRESSURE | LF16 | 15-21AF1LF16 | 15-21AF2LF16 | 10-21AF4LF16 | 10-21AF6LF16 |
| 1/8" HIGH PRESSURE | HF2 | 15-21AF1HF2 | 15-21AF2HF2 | 10-21AF4HF2 | 10-21AF6HF2 |
| 1/4" HIGH PRESSURE | HF4 | 15-21AF1HF4 | 15-21AF2HF4 | 10-21AF4HF4 | 10-21AF6HF4 |
| 3/8" HIGH PRESSURE | HF6 | 15-21AF1HF6 | 15-21AF2HF6 | 10-21AF4HF6 | 10-21AF6HF6 |
| 9/16" HIGH PRESSURE | HF9 | 15-21AF1HF9 | 15-21AF2HF9 | 10-21AF4HF9 | 10-21AF6HF9 |
| 1" HIGH PRESSURE | HF16 | 15-21AF1HF16 | 15-21AF2HF16 | 10-21AF4HF16 | 10-21AF6HF16 |
| 1/4" ULTRA HIGH PRESSURE | XF4 | 15-21AF1XF4 | 15-21AF2XF4 | 10-21AF4XF4 | 10-21AF6XF4 |
| 3/8" ULTRA HIGH PRESSURE | XF6 | 15-21AF1XF6 | 15-21AF2XF6 | 10-21AF4XF6 | 10-21AF6XF6 |
| 1/8" NPT PIPE | NFA | 15-21AF1NFA | 15-21AF2NFA | 10-21AF4NFA | 10-21AF6NFA |
| 1/4" NPT PIPE | NFB | 15-21AF1NFB | 15-21AF2NFB | 10-21AF4NFB | 10-21AF6NFB |
| 3/8" NPT PIPE | NFC | 15-21AF1NFC | 15-21AF2NFC | 10-21AF4NFC | 10-21AF6NFC |
| 1/2" NPT PIPE | NFD | 15-21AF1NFD | 15-21AF2NFD | 10-21AF4NFD | 10-21AF6NFD |
| 3/4" NPT PIPE | NFF | 10-21AF1NFF | 10-21AF2NFF | 10-21AF4NFF | 10-21AF6NFF |
| 1" NPT PIPE | NFH | 10-21AF1NFH | 10-21AF2NFH | 10-21AF4NFH | 10-21AF6NFH |

**Female to Female
(continued)**

| | | HF6 | HF9 | HF16 | XF4 |
|--------------------------|------|--------------------|---------------------|------------------|--------------------------|
| | | 3/8" High Pressure | 9/16" High Pressure | 1" High Pressure | 1/4" Ultra High Pressure |
| 1/16" TAPER SEAL | AF1 | 15-21AF1HF6 | 15-21AF1HF9 | 15-21AF1HF16 | 15-21AF1XF4 |
| 1/8" TAPER SEAL | AF2 | 15-21AF2HF6 | 15-21AF2HF9 | 15-21AF2HF16 | 15-21AF2XF4 |
| 1/4" TAPER SEAL | AF4 | 10-21AF4HF6 | 10-21AF4HF9 | 10-21AF4HF16 | 10-21AF4XF4 |
| 3/8" TAPER SEAL | AF6 | 10-21AF6HF6 | 10-21AF6HF9 | 10-21AF6HF16 | 10-21AF6XF4 |
| 1/4" MEDIUM PRESSURE | LF4 | 20-21LF4HF6 | 20-21LF4HF9 | 20-21LF4HF16 | 20-21LF4XF4 |
| 3/8" MEDIUM PRESSURE | LF6 | 20-21LF6HF6 | 20-21LF6HF9 | 20-21LF6HF16 | 20-21LF6XF4 |
| 9/16" MEDIUM PRESSURE | LF9 | 20-21LF9HF6 | 20-21LF9HF9 | 20-21LF9HF16 | 20-21LF9XF4 |
| 3/4" MEDIUM PRESSURE | LF12 | 20-21LF12HF6 | 20-21LF12HF9 | 20-21LF12HF16 | 20-21LF12XF4 |
| 1" MEDIUM PRESSURE | LF16 | 20-21LF16HF6 | 20-21LF16HF9 | 20-21LF16HF16 | 20-21LF16XF4 |
| 1/8" HIGH PRESSURE | HF2 | 60-21HF2HF6 | 60-21HF2HF9 | 30-21HF2HF16 | 60-21HF2XF4 |
| 1/4" HIGH PRESSURE | HF4 | 60-21HF4HF6 | 60-21HF4HF9 | 30-21HF4HF16 | 60-21HF4XF4 |
| 3/8" HIGH PRESSURE | HF6 | 60-21HF6 | 60-21HF6HF9 | 30-21HF6HF16 | 60-21HF6XF4 |
| 9/16" HIGH PRESSURE | HF9 | 60-21HF6HF9 | 60-21HF9 | 30-21HF9HF16 | 60-21HF9XF4 |
| 1" HIGH PRESSURE | HF16 | 30-21HF6HF16 | 30-21HF9HF16 | 30-21HF16 | 30-21HF16XF4 |
| 1/4" ULTRA HIGH PRESSURE | XF4 | 60-21HF6XF4 | 60-21HF9XF4 | 30-21HF16XF4 | 100-21XF4 |
| 3/8" ULTRA HIGH PRESSURE | XF6 | 60-21HF6XF6 | 60-21HF9XF6 | 30-21HF16XF6 | 100-21XF4XF6 |
| 1/8" NPT PIPE | NFA | 30-21HF6NFA | 30-21HF9NFA | 30-21HF16NFA | 30-21XF4NFA |
| 1/4" NPT PIPE | NFB | 30-21HF6NFB | 30-21HF9NFB | 30-21HF16NFB | 30-21XF4NFB |
| 3/8" NPT PIPE | NFC | 30-21HF6NFC | 30-21HF9NFC | 30-21HF16NFC | 30-21XF4NFC |
| 1/2" NPT PIPE | NFD | 30-21HF6NFD | 30-21HF9NFD | 30-21HF16NFD | 30-21XF4NFD |
| 3/4" NPT PIPE | NFF | 10-21HF6NFF | 10-21HF9NFF | 10-21HF16NFF | 10-21XF4NFF |
| 1" NPT PIPE | NFH | 10-21HF6NFH | 10-21HF9NFH | 10-21HF16NFH | 10-21XF4NFH |

Coupling Selection Guide

| LF4 | LF6 | LF9 | LF12 | LF16 | HF2 | HF4 |
|------------------------------------|------------------------------------|-------------------------------------|------------------------------------|-----------------------|----------------------------------|----------------------------------|
| $\frac{1}{4}$ " Medium Pressure | $\frac{3}{8}$ " Medium Pressure | $\frac{9}{16}$ " Medium Pressure | $\frac{3}{4}$ " Medium Pressure | 1" Medium Pressure | $\frac{1}{8}$ " High Pressure | $\frac{1}{4}$ " High Pressure |
| 15-21AF1LF4 | 15-21AF1LF6 | 15-21AF1LF9 | 15-21AF1LF12 | 15-21AF1LF16 | 15-21AF1HF2 | 15-21AF1HF4 |
| 15-21AF2LF4 | 15-21AF2LF6 | 15-21AF2LF9 | 15-21AF2LF12 | 15-21AF2LF16 | 15-21AF2HF2 | 15-21AF2HF4 |
| 10-21AF4LF4 | 10-21AF4LF6 | 10-21AF4LF9 | 10-21AF4LF12 | 10-21AF4LF16 | 10-21AF4HF2 | 10-21AF4HF4 |
| 10-21AF6LF4 | 10-21AF6LF6 | 10-21AF6LF9 | 10-21AF6LF12 | 10-21AF6LF16 | 10-21AF6HF2 | 10-21AF6HF4 |
| 20-21LF4 | 20-21LF4LF6 | 10-21LF4LF9 | 20-21LF4LF12 | 20-21LF4LF16 | 20-21LF4HF2 | 20-21LF4HF4 |
| 20-21LF4LF6 | 20-21LF6 | 20-21LF6LF9 | 20-21LF6LF12 | 20-21LF6LF16 | 20-21LF6HF2 | 20-21LF6HF4 |
| 20-21LF4LF9 | 20-21LF6LF9 | 20-21LF9 | 20-21LF9LF12 | 20-21LF9LF16 | 20-21LF9HF2 | 20-21LF9HF4 |
| 20-21LF4LF12 | 20-21LF6LF12 | 20-21LF9LF12 | 20-21LF12 | 20-21LF12LF16 | 20-21LF12HF2 | 20-21LF12HF4 |
| 20-21LF4LF16 | 20-21LF6LF16 | 20-21LF9LF16 | 20-21LF12LF16 | 20-21LF16 | 20-21LF16HF2 | 20-21LF16HF4 |
| 20-21LF4HF2 | 20-21LF6HF2 | 20-21LF9HF2 | 20-21LF12HF2 | 20-21LF16HF2 | 60-21HF2 | 60-21HF2HF4 |
| 20-21LF4HF4 | 20-21LF6HF4 | 20-21LF9HF4 | 20-21LF12HF4 | 20-21LF16HF4 | 60-21HF2HF4 | 60-21HF4 |
| 20-21LF4HF6 | 20-21LF6HF6 | 20-21LF9HF6 | 20-21LF12HF6 | 20-21LF16HF6 | 60-21HF2HF6 | 60-21HF4HF6 |
| 20-21LF4HF9 | 20-21LF6HF9 | 20-21LF9HF9 | 20-21LF12HF9 | 20-21LF16HF9 | 60-21HF2HF9 | 60-21HF4HF9 |
| 20-21LF4HF16 | 20-21LF6HF16 | 20-21LF9HF16 | 20-21LF12HF16 | 20-21LF16HF16 | 30-21HF2HF16 | 30-21HF4HF16 |
| 20-21LF4XF4 | 20-21LF6XF4 | 20-21LF9XF4 | 20-21LF12XF4 | 20-21LF16XF4 | 60-21HF2XF4 | 60-21HF4XF4 |
| 20-21LF4XF6 | 20-21LF6XF6 | 20-21LF9XF6 | 20-21LF12XF6 | 20-21LF16XF6 | 60-21HF2XF6 | 60-21HF4XF6 |
| 20-21LF4NFA | 20-21LF6NFA | 20-21LF9NFA | 20-21LF12NFA | 20-21LF16NFA | 30-21HF2NFA | 30-21HF4NFA |
| 20-21LF4NFB | 20-21LF6NFB | 20-21LF9NFB | 20-21LF12NFB | 20-21LF16NFB | 30-21HF2NFB | 30-21HF4NFB |
| 20-21LF4NFC | 20-21LF6NFC | 20-21LF9NFC | 20-21LF12NFC | 20-21LF16NFC | 30-21HF2NFC | 30-21HF4NFC |
| 20-21LF4NFD | 20-21LF6NFD | 20-21LF9NFD | 20-21LF12NFD | 20-21LF16NFD | 30-21HF2NFD | 30-21HF4NFD |
| 10-21LF4NFF | 10-21LF6NFF | 10-21LF9NFF | 10-21LF12NFF | 10-21LF16NFF | 10-21HF2NFF | 10-21HF4NFF |
| 10-21LF4NFH | 10-21LF6NFH | 10-21LF9NFH | 10-21LF12NFH | 10-21LF16NFH | 10-21HF2NFH | 10-21HF4NFH |

| XF6 | NFA | NFB | NFC | NFD | NFF | NFH |
|----------------------------------------|-----------------------------|-----------------------------|-----------------------------|-----------------------------|-----------------------------|----------------|
| $\frac{3}{8}$ " Ultra High Pressure | $\frac{1}{8}$ " NPT Pipe | $\frac{1}{4}$ " NPT Pipe | $\frac{3}{8}$ " NPT Pipe | $\frac{1}{2}$ " NPT Pipe | $\frac{3}{4}$ " NPT Pipe | 1" NPT Pipe |
| 15-21AF1XF6 | 15-21AF1NFA | 15-21AF1NFB | 15-21AF1NFC | 15-21AF1NFD | 10-21AF1NFF | 10-21AF1NFH |
| 15-21AF2XF6 | 15-21AF2NFA | 15-21AF2NFB | 15-21AF2NFC | 15-21AF2NFD | 10-21AF2NFF | 10-21AF2NFH |
| 10-21AF4XF6 | 10-21AF4NFA | 10-21AF4NFB | 10-21AF4NFC | 10-21AF4NFD | 10-21AF4NFF | 10-21AF4NFH |
| 10-21AF6XF6 | 10-21AF6NFA | 10-21AF6NFB | 10-21AF6NFC | 10-21AF6NFD | 10-21AF6NFF | 10-21AF6NFH |
| 20-21LF4XF6 | 20-21LF4NFA | 20-21LF4NFB | 20-21LF4NFC | 20-21LF4NFD | 10-21LF4NFF | 10-21LF4NFH |
| 20-21LF6XF6 | 20-21LF6NFA | 20-21LF6NFB | 20-21LF6NFC | 20-21LF6NFD | 10-21LF6NFF | 10-21LF6NFH |
| 20-21LF9XF6 | 20-21LF9NFA | 20-21LF9NFB | 20-21LF9NFC | 20-21LF9NFD | 10-21LF9NFF | 10-21LF9NFH |
| 20-21LF12XF6 | 20-21LF12NFA | 20-21LF12NFB | 20-21LF12NFC | 20-21LF12NFD | 10-21LF12NFF | 10-21LF12NFH |
| 20-21LF16XF6 | 20-21LF16NFA | 20-21LF16NFB | 20-21LF16NFC | 20-21LF16NFD | 10-21LF16NFF | 10-21LF16NFH |
| 60-21HF2XF6 | 30-21HF2NFA | 30-21HF2NFB | 30-21HF2NFC | 30-21HF2NFD | 10-21HF2NFF | 10-21HF2NFH |
| 60-21HF4XF6 | 30-21HF4NFA | 30-21HF4NFB | 30-21HF4NFC | 30-21HF4NFD | 10-21HF4NFF | 10-21HF4NFH |
| 60-21HF6XF6 | 30-21HF6NFA | 30-21HF6NFB | 30-21HF6NFC | 30-21HF6NFD | 10-21HF6NFF | 10-21HF6NFH |
| 60-21HF9XF6 | 30-21HF9NFA | 30-21HF9NFB | 30-21HF9NFC | 30-21HF9NFD | 10-21HF9NFF | 10-21HF9NFH |
| 30-21HF16XF6 | 30-21HF16NFA | 30-21HF16NFB | 30-21HF16NFC | 30-21HF16NFD | 10-21HF16NFF | 10-21HF16NFH |
| 100-21XF4XF6 | 30-21XF4NFA | 30-21XF4NFB | 30-21XF4NFC | 30-21XF4NFD | 10-21XF4NFF | 10-21XF4NFH |
| 150-21XF6 | 30-21XF6NFA | 30-21XF6NFB | 30-21XF6NFC | 30-21XF6NFD | 10-21XF6NFF | 10-21XF6NFH |
| 30-21XF6NFA | 15-21NFA | 15-21NFANFB | 15-21NFANFC | 15-21NFANFD | 10-21NFANFF | 10-21NFANFH |
| 30-21XF6NFB | 15-21NFB | 15-21NFB | 15-21NFB | 15-21NFB | 10-21NFB | 10-21NFB |
| 30-21XF6NFC | 15-21NFC | 15-21NFC | 15-21NFC | 15-21NFC | 10-21NFC | 10-21NFC |
| 30-21XF6NFD | 15-21NFD | 15-21NFD | 15-21NFD | 15-21NFD | 10-21NFD | 10-21NFD |
| 10-21XF6NFF | 10-21NFF | 10-21NFF | 10-21NFF | 10-21NFF | 10-21NFF | 10-21NFF |
| 10-21XF6NFH | 10-21NFH | 10-21NFH | 10-21NFH | 10-21NFH | 10-21NFH | 10-21NFH |



High Pressure Equipment

Female to Male

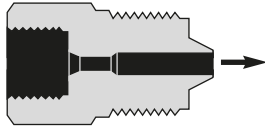

| | | AM1 | AM2 | AM4 | AM6 |
|--------------------------|------|------------------|-----------------|-----------------|-----------------|
| | | 1/16" Taper Seal | 1/8" Taper Seal | 1/4" Taper Seal | 3/8" Taper Seal |
| 1/16" TAPER SEAL | AF1 | 15-21AF1AM1 | 15-21AF1AM2 | 10-21AF1AM4 | 10-21AF1AM6 |
| 1/8" TAPER SEAL | AF2 | 15-21AF2AM1 | 15-21AF2AM2 | 10-21AF2AM4 | 10-21AF2AM6 |
| 1/4" TAPER SEAL | AF4 | 10-21AF4AM1 | 10-21AF4AM2 | 10-21AF4AM4 | 10-21AF4AM6 |
| 3/8" TAPER SEAL | AF6 | 10-21AF6AM1 | 10-21AF6AM2 | 10-21AF6AM4 | 10-21AF6AM6 |
| 1/4" MEDIUM PRESSURE | LF4 | 15-21LF4AM1 | 15-21LF4AM2 | 10-21LF4AM4 | 10-21LF4AM6 |
| 3/8" MEDIUM PRESSURE | LF6 | 15-21LF6AM1 | 15-21LF6AM2 | 10-21LF6AM4 | 10-21LF6AM6 |
| 9/16" MEDIUM PRESSURE | LF9 | 15-21LF9AM1 | 15-21LF9AM2 | 10-21LF9AM4 | 10-21LF9AM6 |
| 3/4" MEDIUM PRESSURE | LF12 | 15-21LF12AM1 | 15-21LF12AM2 | 10-21LF12AM4 | 10-21LF12AM6 |
| 1" MEDIUM PRESSURE | LF16 | 15-21LF16AM1 | 15-21LF16AM2 | 10-21LF16AM4 | 10-21LF16AM6 |
| 1/8" HIGH PRESSURE | HF2 | 15-21HF2AM1 | 15-21HF2AM2 | 10-21HF2AM4 | 10-21HF2AM6 |
| 1/4" HIGH PRESSURE | HF4 | 15-21HF4AM1 | 15-21HF4AM2 | 10-21HF4AM4 | 10-21HF4AM6 |
| 3/8" HIGH PRESSURE | HF6 | 15-21HF6AM1 | 15-21HF6AM2 | 10-21HF6AM4 | 10-21HF6AM6 |
| 9/16" HIGH PRESSURE | HF9 | 15-21HF9AM1 | 15-21HF9AM2 | 10-21HF9AM4 | 10-21HF9AM6 |
| 1" HIGH PRESSURE | HF16 | 15-21HF16AM1 | 15-21HF16AM2 | 10-21HF16AM4 | 10-21HF16AM6 |
| 1/4" ULTRA HIGH PRESSURE | XF4 | 15-21XF4AM1 | 15-21XF4AM2 | 10-21XF4AM4 | 10-21XF4AM6 |
| 3/8" ULTRA HIGH PRESSURE | XF6 | 15-21XF6AM1 | 15-21XF6AM2 | 10-21XF6AM4 | 10-21XF6AM6 |
| 1/8" NPT PIPE | NFA | 15-21NFAAM1 | 15-21NFAAM2 | 10-21NFAAM4 | 10-21NFAAM6 |
| 1/4" NPT PIPE | NFB | 15-21NFBAM1 | 15-21NFBAM2 | 10-21NFBAM4 | 10-21NFBAM6 |
| 3/8" NPT PIPE | NFC | 15-21NFCAM1 | 15-21NFCAM2 | 10-21NFCAM4 | 10-21NFCAM6 |
| 1/2" NPT PIPE | NFD | 15-21NFDAM1 | 15-21NFDAM2 | 10-21NFDAM4 | 10-21NFDAM6 |
| 3/4" NPT PIPE | NFF | 10-21NFFAM1 | 10-21NFFAM2 | 10-21NFFAM4 | 10-21NFFAM6 |
| 1" NPT PIPE | NFH | 10-21NFHAM1 | 10-21NFHAM2 | 10-21NFHAM4 | 10-21NFHAM6 |

Female to Male
(continued)

| | | HM6 | HM9 | HM16 | XM4 |
|--------------------------|------|--------------------|---------------------|------------------|--------------------------|
| | | 3/8" High Pressure | 9/16" High Pressure | 1" High Pressure | 1/4" Ultra High Pressure |
| 1/16" TAPER SEAL | AF1 | 15-21AF1HM6 | 15-21AF1HM9 | 15-21AF1HM16 | 15-21AF1XM4 |
| 1/8" TAPER SEAL | AF2 | 15-21AF2HM6 | 15-21AF2HM9 | 15-21AF2HM16 | 15-21AF2XM4 |
| 1/4" TAPER SEAL | AF4 | 10-21AF4HM6 | 10-21AF4HM9 | 10-21AF4HM16 | 10-21AF4XM4 |
| 3/8" TAPER SEAL | AF6 | 10-21AF6HM6 | 10-21AF6HM9 | 10-21AF6HM16 | 10-21AF6XM4 |
| 1/4" MEDIUM PRESSURE | LF4 | 20-21LF4HM6 | 20-21LF4HM9 | 20-21LF4HM16 | 20-21LF4XM4 |
| 3/8" MEDIUM PRESSURE | LF6 | 20-21LF6HM6 | 20-21LF6HM9 | 20-21LF6HM16 | 20-21LF6XM4 |
| 9/16" MEDIUM PRESSURE | LF9 | 20-21LF9HM6 | 20-21LF9HM9 | 20-21LF9HM16 | 20-21LF9XM4 |
| 3/4" MEDIUM PRESSURE | LF12 | 20-21LF12HM6 | 20-21LF12HM9 | 20-21LF12HM16 | 20-21LF12XM4 |
| 1" MEDIUM PRESSURE | LF16 | 20-21LF16HM6 | 20-21LF16HM9 | 20-21LF16HM16 | 20-21LF16XM4 |
| 1/8" HIGH PRESSURE | HF2 | 60-21HF2HM6 | 60-21HF2HM9 | 30-21HF2HM16 | 60-21HF2XM4 |
| 1/4" HIGH PRESSURE | HF4 | 60-21HF4HM6 | 60-21HF4HM9 | 30-21HF4HM16 | 60-21HF4XM4 |
| 3/8" HIGH PRESSURE | HF6 | 60-21HF6HM6 | 60-21HF6HM9 | 30-21HF6HM16 | 60-21HF6XM4 |
| 9/16" HIGH PRESSURE | HF9 | 60-21HF9HM6 | 60-21HF9HM9 | 30-21HF9HM16 | 60-21HF9XM4 |
| 1" HIGH PRESSURE | HF16 | 30-21HF16HM6 | 30-21HF16HM9 | 30-21HF16HM16 | 30-21HF16XM4 |
| 1/4" ULTRA HIGH PRESSURE | XF4 | 60-21XF4HM6 | 60-21XF4HM9 | 30-21XF4HM16 | 100-21XF4XM4 |
| 3/8" ULTRA HIGH PRESSURE | XF6 | 60-21XF6HM6 | 60-21XF6HM9 | 30-21XF6HM16 | 100-21XF6XM4 |
| 1/8" NPT PIPE | NFA | 30-21NFAHM6 | 30-21NFAHM9 | 30-21NFAHM16 | 30-21NFAXM4 |
| 1/4" NPT PIPE | NFB | 30-21NFBHM6 | 30-21NFBHM9 | 30-21NFBHM16 | 30-21NFBXM4 |
| 3/8" NPT PIPE | NFC | 30-21NFCM6 | 30-21NFCM9 | 30-21NFCM16 | 30-21NFCXM4 |
| 1/2" NPT PIPE | NFD | 30-21NFDHM6 | 30-21NFDHM9 | 30-21NFDHM16 | 30-21NFDXM4 |
| 3/4" NPT PIPE | NFF | 10-21NFFHM6 | 10-21NFFHM9 | 10-21NFFHM16 | 10-21NFFXM4 |
| 1" NPT PIPE | NFH | 10-21NFHHM6 | 10-21NFHHM9 | 10-21NFHHM16 | 10-21NFHXM4 |

Adapter Selection Guide

| LM4 | LM6 | LM9 | LM12 | LM16 | HM2 | HM4 |
|------------------------------------|------------------------------------|-------------------------------------|------------------------------------|-----------------------|----------------------------------|----------------------------------|
| $\frac{1}{4}$ " Medium Pressure | $\frac{3}{8}$ " Medium Pressure | $\frac{9}{16}$ " Medium Pressure | $\frac{3}{4}$ " Medium Pressure | 1" Medium Pressure | $\frac{1}{8}$ " High Pressure | $\frac{1}{4}$ " High Pressure |
| 15-21AF1LM4 | 15-21AF1LM6 | 15-21AF1LM9 | 15-21AF1LM12 | 15-21AF1LM16 | 15-21AF1HM2 | 15-21AF1HM4 |
| 15-21AF2LM4 | 15-21AF2LM6 | 15-21AF2LM9 | 15-21AF2LM12 | 15-21AF2LM16 | 15-21AF2HM2 | 15-21AF2HM4 |
| 10-21AF4LM4 | 10-21AF4LM6 | 10-21AF4LM9 | 10-21AF4LM12 | 10-21AF4LM16 | 10-21AF4HM2 | 10-21AF4HM4 |
| 10-21AF6LM4 | 10-21AF6LM6 | 10-21AF6LM9 | 10-21AF6LM12 | 10-21AF6LM16 | 10-21AF6HM2 | 10-21AF6HM4 |
| 20-21LF4LM4 | 20-21LF4LM6 | 20-21LF4LM9 | 20-21LF4LM12 | 20-21LF4LM16 | 20-21LF4HM2 | 20-21LF4HM4 |
| 20-21LF6LM4 | 20-21LF6LM6 | 20-21LF6LM9 | 20-21LF6LM12 | 20-21LF6LM16 | 20-21LF6HM2 | 20-21LF6HM4 |
| 20-21LF9LM4 | 20-21LF9LM6 | 20-21LF9LM9 | 20-21LF9LM12 | 20-21LF9LM16 | 20-21LF9HM2 | 20-21LF9HM4 |
| 20-21LF12LM4 | 20-21LF12LM6 | 20-21LF12LM9 | 20-21LF12LM12 | 20-21LF12LM16 | 20-21LF12HM2 | 20-21LF12HM4 |
| 20-21LF16LM4 | 20-21LF16LM6 | 20-21LF16LM9 | 20-21LF16LM12 | 20-21LF16LM16 | 20-21LF16HM2 | 20-21LF16HM4 |
| 20-21HF2LM4 | 20-21HF2LM6 | 20-21HF2LM9 | 20-21HF2LM12 | 20-21HF2LM16 | 60-21HF2HM2 | 60-21HF2HM4 |
| 20-21HF4LM4 | 20-21HF4LM6 | 20-21HF4LM9 | 20-21HF4LM12 | 20-21HF4LM16 | 60-21HF4HM2 | 60-21HF4HM4 |
| 20-21HF6LM4 | 20-21HF6LM6 | 20-21HF6LM9 | 20-21HF6LM12 | 20-21HF6LM16 | 60-21HF6HM2 | 60-21HF6HM4 |
| 20-21HF9LM4 | 20-21HF9LM6 | 20-21HF9LM9 | 20-21HF9LM12 | 20-21HF9LM16 | 60-21HF9HM2 | 60-21HF9HM4 |
| 20-21HF16LM4 | 20-21HF16LM6 | 20-21HF16LM9 | 20-21HF16LM12 | 20-21HF16LM16 | 30-21HF16HM2 | 30-21HF16HM4 |
| 20-21XF4LM4 | 20-21XF4LM6 | 20-21XF4LM9 | 20-21XF4LM12 | 20-21XF4LM16 | 60-21XF4HM2 | 60-21XF4HM4 |
| 20-21XF6LM4 | 20-21XF6LM6 | 20-21XF6LM9 | 20-21XF6LM12 | 20-21XF6LM16 | 60-21XF6HM2 | 60-21XF6HM4 |
| 20-21NFALM4 | 20-21NFALM6 | 20-21NFALM9 | 20-21NFALM12 | 20-21NFALM16 | 30-21NFAHM2 | 30-21NFAHM4 |
| 20-21NFBLM4 | 20-21NFBLM6 | 20-21NFBLM9 | 20-21NFBLM12 | 20-21NFBLM16 | 30-21NFBHM2 | 30-21NFBHM4 |
| 20-21NFCLM4 | 20-21NFCLM6 | 20-21NFCLM9 | 20-21NFCLM12 | 20-21NFCLM16 | 30-21NFCM2 | 30-21NFCM4 |
| 20-21NFDLM4 | 20-21NFDLM6 | 20-21NFDLM9 | 20-21NFDLM12 | 20-21NFDLM16 | 30-21NFDHM2 | 30-21NFDHM4 |
| 10-21NFFLM4 | 10-21NFFLM6 | 10-21NFFLM9 | 10-21NFFLM12 | 10-21NFFLM16 | 10-21NFFHM2 | 10-21NFFHM4 |
| 10-21NFHLM4 | 10-21NFHLM6 | 10-21NFHLM9 | 10-21NFHLM12 | 10-21NFHLM16 | 10-21NFHHM2 | 10-21NFHHM4 |

| XM6 | NMA | NMB | NMC | NMD | NMF | NMH |
|----------------------------------------|-----------------------------|-----------------------------|-----------------------------|-----------------------------|-----------------------------|----------------|
| $\frac{3}{8}$ " Ultra High Pressure | $\frac{1}{8}$ " NPT Pipe | $\frac{1}{4}$ " NPT Pipe | $\frac{3}{8}$ " NPT Pipe | $\frac{1}{2}$ " NPT Pipe | $\frac{3}{4}$ " NPT Pipe | 1" NPT Pipe |
| 15-21AF1XM6 | 15-21AF1NMA | 15-21AF1NMB | 15-21AF1NMC | 15-21AF1NMD | 10-21AF1NMF | 10-21AF1NMH |
| 15-21AF2XM6 | 15-21AF2NMA | 15-21AF2NMB | 15-21AF2NMC | 15-21AF2NMD | 10-21AF2NMF | 10-21AF2NMH |
| 10-21AF4XM6 | 10-21AF4NMA | 10-21AF4NMB | 10-21AF4NMC | 10-21AF4NMD | 10-21AF4NMF | 10-21AF4NMH |
| 10-21AF6XM6 | 10-21AF6NMA | 10-21AF6NMB | 10-21AF6NMC | 10-21AF6NMD | 10-21AF6NMF | 10-21AF6NMH |
| 20-21LF4XM6 | 20-21LF4NMA | 20-21LF4NMB | 20-21LF4NMC | 20-21LF4NMD | 10-21LF4NMF | 10-21LF4NMH |
| 20-21LF6XM6 | 20-21LF6NMA | 20-21LF6NMB | 20-21LF6NMC | 20-21LF6NMD | 10-21LF6NMF | 10-21LF6NMH |
| 20-21LF9XM6 | 20-21LF9NMA | 20-21LF9NMB | 20-21LF9NMC | 20-21LF9NMD | 10-21LF9NMF | 10-21LF9NMH |
| 20-21LF12XM6 | 20-21LF12NMA | 20-21LF12NMB | 20-21LF12NMC | 20-21LF12NMD | 10-21LF12NMF | 10-21LF12NMH |
| 20-21LF16XM6 | 20-21LF16NMA | 20-21LF16NMB | 20-21LF16NMC | 20-21LF16NMD | 10-21LF16NMF | 10-21LF16NMH |
| 60-21HF2XM6 | 30-21HF2NMA | 30-21HF2NMB | 30-21HF2NMC | 30-21HF2NMD | 10-21HF2NMF | 10-21HF2NMH |
| 60-21HF4XM6 | 30-21HF4NMA | 30-21HF4NMB | 30-21HF4NMC | 30-21HF4NMD | 10-21HF4NMF | 10-21HF4NMH |
| 60-21HF6XM6 | 30-21HF6NMA | 30-21HF6NMB | 30-21HF6NMC | 30-21HF6NMD | 10-21HF6NMF | 10-21HF6NMH |
| 60-21HF9XM6 | 30-21HF9NMA | 30-21HF9NMB | 30-21HF9NMC | 30-21HF9NMD | 10-21HF9NMF | 10-21HF9NMH |
| 30-21HF16XM6 | 30-21HF16NMA | 30-21HF16NMB | 30-21HF16NMC | 30-21HF16NMD | 10-21HF16NMF | 10-21HF16NMH |
| 100-21XF4XM6 | 30-21XF4NMA | 30-21XF4NMB | 30-21XF4NMC | 30-21XF4NMD | 10-21XF4NMF | 10-21XF4NMH |
| 150-21XF6XM6 | 30-21XF6NMA | 30-21XF6NMB | 30-21XF6NMC | 30-21XF6NMD | 10-21XF6NMF | 10-21XF6NMH |
| 30-21NFXM6 | 15-21NFANMA | 15-21NFANMB | 15-21NFANMC | 15-21NFANMD | 10-21NFANMF | 10-21NFANMH |
| 30-21NFBXM6 | 15-21NFBNMA | 15-21NFBNMB | 15-21NFBNMC | 15-21NFBNMD | 10-21NFBNMF | 10-21NFBNMH |
| 30-21NFCXM6 | 15-21NFCNMA | 15-21NFCNMB | 15-21NFCNMC | 15-21NFCNMD | 10-21NFCNMF | 10-21NFCNMH |
| 30-21NFDXM6 | 15-21NFDNMA | 15-21NFDNMB | 15-21NFDNMC | 15-21NFDNMD | 10-21NFDNMF | 10-21NFDNMH |
| 10-21NFFXM6 | 10-21NFFNMA | 10-21NFFNMB | 10-21NFFNMC | 10-21NFFNMD | 10-21NFFNMF | 10-21NFFNMH |
| 10-21NFHXM6 | 10-21NFHNMA | 10-21NFHNMB | 10-21NFHNMC | 10-21NFHNMD | 10-21NFHNMF | 10-21NFHNMH |



High Pressure Equipment

Male to Male

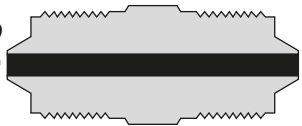

| | | AM1 | AM2 | AM4 | AM6 |
|--------------------------|------|------------------|-----------------|-----------------|-----------------|
| | | 1/16" Taper Seal | 1/8" Taper Seal | 1/4" Taper Seal | 3/8" Taper Seal |
| 1/16" TAPER SEAL | AM1 | 15-21AM1AM1 | 15-21AM1AM2 | 10-21AM1AM4 | 10-21AM1AM6 |
| 1/8" TAPER SEAL | AM2 | 15-21AM1AM2 | 15-21AM2AM2 | 10-21AM2AM4 | 10-21AM2AM6 |
| 1/4" TAPER SEAL | AM4 | 10-21AM1AM4 | 10-21AM2AM4 | 10-21AM4AM4 | 10-21AM4AM6 |
| 3/8" TAPER SEAL | AM6 | 10-21AM1AM6 | 10-21AM2AM6 | 10-21AM4AM6 | 10-21AM6AM6 |
| 1/4" MEDIUM PRESSURE | LM4 | 15-21AM1LM4 | 15-21AM2LM4 | 10-21AM4LM4 | 10-21AM6LM4 |
| 3/8" MEDIUM PRESSURE | LM6 | 15-21AM1LM6 | 15-21AM2LM6 | 10-21AM4LM6 | 10-21AM6LM6 |
| 9/16" MEDIUM PRESSURE | LM9 | 15-21AM1LM9 | 5-21AM2LM9 | 10-21AM4LM9 | 10-21AM6LM9 |
| 3/4" MEDIUM PRESSURE | LM12 | 15-21AM1LM12 | 15-21AM2LM12 | 10-21AM4LM12 | 10-21AM6LM12 |
| 1" MEDIUM PRESSURE | LM16 | 15-21AM1LM16 | 15-21AM2LM16 | 10-21AM4LM16 | 10-21AM6LM16 |
| 1/8" HIGH PRESSURE | HM2 | 15-21AM1HM2 | 15-21AM2HM2 | 10-21AM4HM2 | 10-21AM6HM2 |
| 1/4" HIGH PRESSURE | HM4 | 15-21AM1HM4 | 15-21AM2HM4 | 10-21AM4HM4 | 10-21AM6HM4 |
| 3/8" HIGH PRESSURE | HM6 | 15-21AM1HM6 | 15-21AM2HM6 | 10-21AM4HM6 | 10-21AM6HM6 |
| 9/16" HIGH PRESSURE | HM9 | 15-21AM1HM9 | 15-21AM2HM9 | 10-21AM4HM9 | 10-21AM6HM9 |
| 1" HIGH PRESSURE | HM16 | 15-21AM1HM16 | 15-21AM2HM16 | 10-21AM4HM16 | 10-21AM6HM16 |
| 1/4" ULTRA HIGH PRESSURE | XM4 | 15-21AM1XM4 | 15-21AM2XM4 | 10-21AM4XM4 | 10-21AM6XM4 |
| 3/8" ULTRA HIGH PRESSURE | XM6 | 15-21AM1XM6 | 15-21AM2XM6 | 10-21AM4XM6 | 10-21AM6XM6 |
| 1/8" NPT PIPE | NMA | 15-21AM1NMA | 15-21AM2NMA | 10-21AM4NMA | 10-21AM6NMA |
| 1/4" NPT PIPE | NMB | 15-21AM1NMB | 15-21AM2NMB | 10-21AM4NMB | 10-21AM6NMB |
| 3/8" NPT PIPE | NMC | 15-21AM1NMC | 15-21AM2NMC | 10-21AM4NMC | 10-21AM6NMC |
| 1/2" NPT PIPE | NMD | 15-21AM1NMD | 15-21AM2NMD | 10-21AM4NMD | 10-21AM6NMD |
| 3/4" NPT PIPE | NMF | 10-21AM1NMF | 10-21AM2NMF | 10-21AM4NMF | 10-21AM6NMF |
| 1" NPT PIPE | NMH | 10-21AM1NMH | 10-21AM2NMH | 10-21AM4NMH | 10-21AM6NMH |

Male to Male (continued)

| | | HM6 | HM9 | HM16 | XM4 |
|--------------------------|------|--------------------|---------------------|------------------|--------------------------|
| | | 3/8" High Pressure | 9/16" High Pressure | 1" High Pressure | 1/4" Ultra High Pressure |
| 1/16" TAPER SEAL | AM1 | 15-21AM1HM6 | 15-21AM1HM9 | 15-21AM1HM16 | 15-21AM1XM4 |
| 1/8" TAPER SEAL | AM2 | 15-21AM2HM6 | 15-21AM2HM9 | 15-21AM2HM16 | 15-21AM2XM4 |
| 1/4" TAPER SEAL | AM4 | 10-21AM4HM6 | 10-21AM4HM9 | 10-21AM4HM16 | 10-21AM4XM4 |
| 3/8" TAPER SEAL | AM6 | 10-21AM6HM6 | 10-21AM6HM9 | 10-21AM6HM16 | 10-21AM6XM4 |
| 1/4" MEDIUM PRESSURE | LM4 | 20-21LM4HM6 | 20-21LM4HM9 | 20-21LM4HM16 | 20-21LM4XM4 |
| 3/8" MEDIUM PRESSURE | LM6 | 20-21LM6HM6 | 20-21LM6HM9 | 20-21LM6HM16 | 20-21LM6XM4 |
| 9/16" MEDIUM PRESSURE | LM9 | 20-21LM9HM6 | 20-21LM9HM9 | 20-21LM9HM16 | 20-21LM9XM4 |
| 3/4" MEDIUM PRESSURE | LM12 | 20-21LM12HM6 | 20-21LM12HM9 | 20-21LM12HM16 | 20-21LM12XM4 |
| 1" MEDIUM PRESSURE | LM16 | 20-21LM16HM6 | 20-21LM16HM9 | 20-21LM16HM16 | 20-21LM16XM4 |
| 1/8" HIGH PRESSURE | HM2 | 60-21HM2HM6 | 60-21HM2HM9 | 60-21HM2HM16 | 60-21HM2XM4 |
| 1/4" HIGH PRESSURE | HM4 | 60-21HM4HM6 | 60-21HM4HM9 | 60-21HM4HM16 | 60-21HM4XM4 |
| 3/8" HIGH PRESSURE | HM6 | 60-21HM6HM6 | 60-21HM6HM9 | 60-21HM6HM16 | 60-21HM6XM4 |
| 9/16" HIGH PRESSURE | HM9 | 60-21HM9HM6 | 60-21HM9HM9 | 30-21HM9HM16 | 60-21HM9XM4 |
| 1" HIGH PRESSURE | HM16 | 30-21HM6HM16 | 30-21HM9HM16 | 30-21HM16HM16 | 30-21HM16XM4 |
| 1/4" ULTRA HIGH PRESSURE | XM4 | 60-21HM6XM4 | 60-21HM9XM4 | 60-21HM16XM4 | 100-21XM4XM4 |
| 3/8" ULTRA HIGH PRESSURE | XM6 | 60-21HM6XM6 | 60-21HM9XM6 | 60-21HM16XM6 | 100-21XM4XM6 |
| 1/8" NPT PIPE | NMA | 30-21HM6NMA | 30-21HM9NMA | 30-21HM16NMA | 30-21XM4NMA |
| 1/4" NPT PIPE | NMB | 30-21HM6NMB | 30-21HM9NMB | 30-21HM16NMB | 30-21XM4NMB |
| 3/8" NPT PIPE | NMC | 30-21HM6NMC | 30-21HM9NMC | 30-21HM16NMC | 30-21XM4NMC |
| 1/2" NPT PIPE | NMD | 30-21HM6NMD | 30-21HM9NMD | 30-21HM16NMD | 30-21XM4NMD |
| 3/4" NPT PIPE | NMF | 10-21HM6NMF | 10-21HM9NMF | 10-21HM16NMF | 10-21XM4NMF |
| 1" NPT PIPE | NMH | 10-21HM6NMH | 10-21HM9NMH | 10-21HM16NMH | 10-21XM4NMH |

Adapter Selection Guide

| LM4 | LM6 | LM9 | LM12 | LM16 | HM2 | HM4 |
|------------------------------------|------------------------------------|-------------------------------------|------------------------------------|-----------------------|----------------------------------|----------------------------------|
| $\frac{1}{4}$ " Medium Pressure | $\frac{3}{8}$ " Medium Pressure | $\frac{9}{16}$ " Medium Pressure | $\frac{3}{4}$ " Medium Pressure | 1" Medium Pressure | $\frac{1}{8}$ " High Pressure | $\frac{1}{4}$ " High Pressure |
| 15-21AM1LM4 | 15-21AM1LM6 | 15-21AM1LM9 | 15-21AM1LM12 | 15-21AM1LM16 | 15-21AM1HM2 | 15-21AM1HM4 |
| 15-21AM2LM4 | 15-21AM2LM6 | 15-21AM2LM9 | 15-21AM2LM12 | 15-21AM2LM16 | 15-21AM2HM2 | 15-21AM2HM4 |
| 10-21AM4LM4 | 10-21AM4LM6 | 10-21AM4LM9 | 10-21AM4LM12 | 10-21AM4LM16 | 10-21AM4HM2 | 10-21AM4HM4 |
| 10-21AM6LM4 | 10-21AM6LM6 | 10-21AM6LM9 | 10-21AM6LM12 | 10-21AM6LM16 | 10-21AM6HM2 | 10-21AM6HM4 |
| 20-21LM4LM4 | 20-21LM4LM6 | 10-21LM4LM9 | 20-21LM4LM12 | 20-21LM4LM16 | 20-21LM4HM2 | 20-21LM4HM4 |
| 20-21LM4LM6 | 20-21LM6LM6 | 20-21LM6LM9 | 20-21LM6LM12 | 20-21LM6LM16 | 20-21LM6HM2 | 20-21LM6HM4 |
| 20-21LM4LM9 | 20-21LM6LM9 | 20-21LM9LM9 | 20-21LM9LM12 | 20-21LM9LM16 | 20-21LM9HM2 | 20-21LM9HM4 |
| 20-21LM4LM12 | 20-21LM6LM12 | 20-21LM9LM12 | 20-21LM12LM12 | 20-21LM12LM16 | 20-21LM12HM2 | 20-21LM12HM4 |
| 20-21LM4LM16 | 20-21LM6LM16 | 20-21LM9LM16 | 20-21LM12LM16 | 20-21LM16LM16 | 20-21LM16HM2 | 20-21LM16HM4 |
| 20-21LM4HM2 | 20-21LM6HM2 | 20-21LM9HM2 | 20-21LM12HM2 | 20-21LM16HM2 | 60-21HM2HM2 | 60-21HM2HM4 |
| 20-21LM4HM4 | 20-21LM6HM4 | 20-21LM9HM4 | 20-21LM12HM4 | 20-21LM16HM4 | 60-21HM2HM4 | 60-21HM4HM4 |
| 20-21LM4HM6 | 20-21LM6HM6 | 20-21LM9HM6 | 20-21LM12HM6 | 20-21LM16HM6 | 60-21HM2HM6 | 60-21HM4HM6 |
| 20-21LM4HM9 | 20-21LM6HM9 | 20-21LM9HM9 | 20-21LM12HM9 | 20-21LM16HM9 | 60-21HM2HM9 | 60-21HM4HM9 |
| 20-21LM4HM16 | 20-21LM6HM16 | 20-21LM9HM16 | 20-21LM12HM16 | 20-21LM16HM16 | 30-21HM2HM16 | 30-21HM4HM16 |
| 20-21LM4XM4 | 20-21LM6XM4 | 20-21LM9XM4 | 20-21LM12XM4 | 20-21LM16XM4 | 60-21HM2XM4 | 60-21HM4XM4 |
| 20-21LM4XM6 | 20-21LM6XM6 | 20-21LM9XM6 | 20-21LM12XM6 | 20-21LM16XM6 | 60-21HM2XM6 | 60-21HM4XM6 |
| 20-21LM4NMA | 20-21LM6NMA | 20-21LM9NMA | 20-21LM12NMA | 20-21LM16NMA | 30-21HM2NMA | 30-21HM4NMA |
| 20-21LM4NMB | 20-21LM6NMB | 20-21LM9NMB | 20-21LM12NMB | 20-21LM16NMB | 30-21HM2NMB | 30-21HM4NMB |
| 20-21LM4NMC | 20-21LM6NMC | 20-21LM9NMC | 20-21LM12NMC | 20-21LM16NMC | 30-21HM2NMC | 30-21HM4NMC |
| 20-21LM4NMD | 20-21LM6NMD | 20-21LM9NMD | 20-21LM12NMD | 20-21LM16NMD | 30-21HM2NMD | 30-21HM4NMD |
| 10-21LM4NMF | 10-21LM6NMF | 10-21LM9NMF | 10-21LM12NMF | 10-21LM16NMF | 10-21HM2NMF | 10-21HM4NMF |
| 10-21LM4NMH | 10-21LM6NMH | 10-21LM9NMH | 10-21LM12NMH | 10-21LM16NMH | 10-21HM2NMH | 10-21HM4NMH |

| XM6 | NMA | NMB | NMC | NMD | NMF | NMH |
|----------------------------------------|-----------------------------|-----------------------------|-----------------------------|-----------------------------|-----------------------------|----------------|
| $\frac{3}{8}$ " Ultra High Pressure | $\frac{1}{8}$ " NPT Pipe | $\frac{1}{4}$ " NPT Pipe | $\frac{3}{8}$ " NPT Pipe | $\frac{1}{2}$ " NPT Pipe | $\frac{3}{4}$ " NPT Pipe | 1" NPT Pipe |
| 15-21AM1XM6 | 15-21AM1NMA | 15-21AM1NMB | 15-21AMANMC | 15-21AMANMD | 10-21AM1NMF | 10-21AM1NMH |
| 15-21AM2XM6 | 15-21AM2NMA | 15-21AM2NMB | 15-21AM2NMC | 15-21AM2NMD | 10-21AM2NMF | 10-21AM2NMH |
| 10-21AM4XM6 | 10-21AM4NMA | 10-21AM4NMB | 10-21AM4NMC | 10-21AM4NMD | 10-21AM4NMF | 10-21AM4NMH |
| 10-21AM6XM6 | 10-21AM6NMA | 10-21AM6NMB | 10-21AM6NMC | 10-21AM6NMD | 10-21AM6NMF | 10-21AM6NMH |
| 20-21LM4XM6 | 20-21LM4NMA | 20-21LM4NMB | 20-21LM4NMC | 20-21LM4NMD | 10-21LM4NMF | 10-21LM4NMH |
| 20-21LM6XM6 | 20-21LM6NMA | 20-21LM6NMB | 20-21LM6NMC | 20-21LM6NMD | 10-21LM6NMF | 10-21LM6NMH |
| 20-21LM9XM6 | 20-21LM9NMA | 20-21LM9NMB | 20-21LM9NMC | 20-21LM9NMD | 10-21LM9NMF | 10-21LM9NMH |
| 20-21LM12XM6 | 20-21LM12NMA | 20-21LM12NMB | 20-21LM12NMC | 20-21LM12NMD | 10-21LM12NMF | 10-21LM12NMH |
| 20-21LM16XM6 | 20-21LM16NMA | 20-21LM16NMB | 20-21LM16NMC | 20-21LM16NMD | 10-21LM16NMF | 10-21LM16NMH |
| 60-21HM2XM6 | 30-21HM2NMA | 30-21HM2NMB | 30-21HM2NMC | 30-21HM2NMD | 10-21HM2NMF | 10-21HM2NMH |
| 60-21HM4XM6 | 30-21HM4NMA | 30-21HM4NMB | 30-21HM4NMC | 30-21HM4NMD | 10-21HM4NMF | 10-21HM4NMH |
| 60-21HM6XM6 | 30-21HM6NMA | 30-21HM6NMB | 30-21HM6NMC | 30-21HM6NMD | 10-21HM6NMF | 10-21HM6NMH |
| 60-21HM9XM6 | 30-21HM9NMA | 30-21HM9NMB | 30-21HM9NMC | 30-21HM9NMD | 10-21HM9NMF | 10-21HM9NMH |
| 30-21HM16XM6 | 30-21HM16NMA | 30-21HM16NMB | 30-21HM16NMC | 30-21HM16NMD | 10-21HM16NMF | 10-21HM16NMH |
| 100-21XM4XM6 | 30-21XM4NMA | 30-21XM4NMB | 30-21XM4NMC | 30-21XM4NMD | 10-21XM4NMF | 10-21XM4NMH |
| 150-21XM6XM6 | 30-21XM6NMA | 30-21XM6NMB | 30-21XM6NMC | 30-21XM6NMD | 10-21XM6NMF | 10-21XM6NMH |
| 30-21XM6NMA | 15-21NMANMA | 15-21NMANMA | 15-21NMANMC | 15-21NMANMD | 10-21NMANMF | 10-21NMANMH |
| 30-21XM6NMB | 15-21NMANMB | 15-21NMBNMB | 15-21NMBNMC | 15-21NMBNMD | 10-21NMBNMF | 10-21NMBNMH |
| 30-21XM6NMC | 15-21NMANMC | 15-21NMBNMC | 15-21NMCNMC | 15-21NMCNMD | 10-21NMCNMF | 10-21NMCNMH |
| 30-21XM6NMD | 15-21NMANMD | 15-21NMBNMD | 15-21NMCNMD | 15-21NMDNMD | 10-21NMDNMF | 10-21NMDNMH |
| 10-21XM6NMF | 10-21NMANMF | 10-21NMBNMF | 10-21NMCNMF | 10-21NMDNMF | 10-21NMFNMF | 10-21NMFNMH |
| 10-21XM6NMH | 10-21NMANMH | 10-21NMBNMH | 10-21NMCNMH | 10-21NMDNMH | 10-21NMFNMH | 10-21NMHNMH |



High Pressure Equipment



Adapters: Female to Male

A complete range of adapters is offered for flexibility in going from tube to tube and from tube to pipe.

All standard adapter bodies are made from high tensile 316 stainless steel. Standard tubing glands and collars (sleeves) are provided with adapters unless otherwise specified.

Female Taper Seal to Male Taper Seal

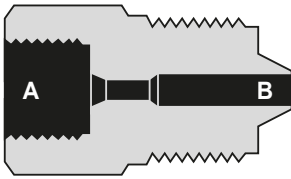

| Catalog No. | Pressure Rating psi | Connections | A | B | Length | Hex Size |
|-------------|---------------------|------------------------------------|-----|-----|--------|----------|
| 15-21AF1AM2 | 15,000 | 1/16" O.D. TUBE TO 1/8" TAPER SEAL | AF1 | AM2 | 15/16" | 5/8" |
| 10-21AF1AM4 | 10,000 | 1/16" O.D. TUBE TO 1/4" TAPER SEAL | AF1 | AM4 | 1 1/4" | 3/4" |
| 10-21AF1AM6 | 10,000 | 1/16" O.D. TUBE TO 3/8" TAPER SEAL | AF1 | AM6 | 1 1/4" | 3/4" |
| 10-21AF2AM4 | 10,000 | 1/8" O.D. TUBE TO 1/4" TAPER SEAL | AF2 | AM4 | 1 1/4" | 3/4" |
| 10-21AF2AM6 | 10,000 | 1/8" O.D. TUBE TO 3/8" TAPER SEAL | AF2 | AM6 | 1 1/4" | 3/4" |

Female Taper Seal to Male High Pressure

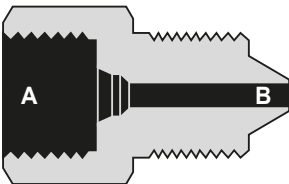

| Catalog No. | Pressure Rating psi | Connections | A | B | Length | Hex Size |
|-------------|---------------------|-------------------------------|-----|-----|---------|----------|
| 15-21AF1HM2 | 15,000 | 1/16" T.S. TO 1/8" H.P. MALE | AF1 | HM2 | 7/8" | 1/2" |
| 15-21AF1HM4 | 15,000 | 1/16" T.S. TO 1/4" H.P. MALE | AF1 | HM4 | 1 1/4" | 5/8" |
| 15-21AF1HM6 | 15,000 | 1/16" T.S. TO 3/8" H.P. MALE | AF1 | HM6 | 1 3/4" | 3/4" |
| 15-21AF1HM9 | 15,000 | 1/16" T.S. TO 9/16" H.P. MALE | AF1 | HM9 | 2 1/8" | 1 1/8" |
| 15-21AF2HM2 | 15,000 | 1/8" T.S. TO 1/8" H.P. MALE | AF2 | HM2 | 1 1/8" | 5/8" |
| 15-21AF2HM4 | 15,000 | 1/8" T.S. TO 1/4" H.P. MALE | AF2 | HM4 | 1 1/4" | 5/8" |
| 15-21AF2HM6 | 15,000 | 1/8" T.S. TO 3/8" H.P. MALE | AF2 | HM6 | 1 3/4" | 3/4" |
| 15-21AF2HM9 | 15,000 | 1/8" T.S. TO 9/16" H.P. MALE | AF2 | HM9 | 2 1/8" | 1 1/8" |
| 10-21AF4HM2 | 10,000 | 1/4" T.S. TO 1/8" H.P. MALE | AF4 | HM2 | 1 7/16" | 1" |
| 10-21AF4HM4 | 10,000 | 1/4" T.S. TO 1/4" H.P. MALE | AF4 | HM4 | 1 1/2" | 1" |
| 10-21AF4HM6 | 10,000 | 1/4" T.S. TO 3/8" H.P. MALE | AF4 | HM6 | 1 5/8" | 1" |
| 10-21AF4HM9 | 10,000 | 1/4" T.S. TO 9/16" H.P. MALE | AF4 | HM9 | 2 1/8" | 1 1/8" |
| 10-21AF6HM2 | 10,000 | 3/8" T.S. TO 1/8" H.P. MALE | AF6 | HM2 | 1 1/2" | 1" |
| 10-21AF6HM4 | 10,000 | 3/8" T.S. TO 1/4" H.P. MALE | AF6 | HM4 | 1 1/2" | 1" |
| 10-21AF6HM6 | 10,000 | 3/8" T.S. TO 3/8" H.P. MALE | AF6 | HM6 | 1 3/4" | 1" |
| 10-21AF6HM9 | 10,000 | 3/8" T.S. TO 9/16" H.P. MALE | AF6 | HM9 | 2 1/8" | 1 1/8" |

Female to Male Adapters

Female Taper Seal to Male Pipe

| Catalog No. | Pressure Rating psi | Connections | A | B | Length | Hex Size |
|-------------|---------------------|-----------------------------|-----|-----|--------|----------|
| 15-21AF1NMA | 15,000 | 1/16" T.S. TO 1/8" NPT MALE | AF1 | NMA | 1" | 1/2" |
| 15-21AF1NMB | 15,000 | 1/16" T.S. TO 1/4" NPT MALE | AF1 | NMB | 1 1/4" | 5/8" |
| 15-21AF1NMC | 15,000 | 1/16" T.S. TO 3/8" NPT MALE | AF1 | NMC | 1 3/8" | 3/4" |
| 15-21AF1NMD | 15,000 | 1/16" T.S. TO 1/2" NPT MALE | AF1 | NMD | 1 3/4" | 1" |
| 15-21AF1NMF | 15,000 | 1/16" T.S. TO 3/4" NPT MALE | AF1 | NMF | 1 5/8" | 1 3/8" |
| 15-21AF1NMH | 15,000 | 1/16" T.S. TO 1" NPT MALE | AF1 | NMH | 1 5/8" | 1 3/8" |
| 15-21AF2NMA | 15,000 | 1/8" T.S. TO 1/8" NPT MALE | AF2 | NMA | 1 1/4" | 3/4" |
| 15-21AF2NMB | 15,000 | 1/8" T.S. TO 1/4" NPT MALE | AF2 | NMB | 1 1/4" | 5/8" |
| 15-21AF2NMC | 15,000 | 1/8" T.S. TO 3/8" NPT MALE | AF2 | NMC | 1 3/8" | 3/4" |
| 15-21AF2NMD | 15,000 | 1/8" T.S. TO 1/2" NPT MALE | AF2 | NMD | 1 3/4" | 1" |
| 15-21AF2NMF | 15,000 | 1/8" T.S. TO 3/4" NPT MALE | AF2 | NMF | 1 5/8" | 1 3/8" |
| 15-21AF2NMH | 15,000 | 1/8" T.S. TO 1" NPT MALE | AF2 | NMH | 1 5/8" | 1 3/8" |
| 10-21AF4NMA | 10,000 | 1/4" T.S. TO 1/8" NPT MALE | AF4 | NMA | 1 1/2" | 1" |
| 10-21AF4NMB | 10,000 | 1/4" T.S. TO 1/4" NPT MALE | AF4 | NMB | 1 5/8" | 1" |
| 10-21AF4NMC | 10,000 | 1/4" T.S. TO 3/8" NPT MALE | AF4 | NMC | 1 5/8" | 1" |
| 10-21AF4NMD | 10,000 | 1/4" T.S. TO 1/2" NPT MALE | AF4 | NMD | 1 3/4" | 1" |
| 10-21AF4NMF | 10,000 | 1/4" T.S. TO 3/4" NPT MALE | AF4 | NMF | 1 1/2" | 1 3/8" |
| 10-21AF4NMH | 10,000 | 1/4" T.S. TO 1" NPT MALE | AF4 | NMH | 1 7/8" | 1 3/8" |
| 10-21AF6NMA | 10,000 | 3/8" T.S. TO 1/8" NPT MALE | AF6 | NMA | 1 1/2" | 1" |
| 10-21AF6NMB | 10,000 | 3/8" T.S. TO 1/4" NPT MALE | AF6 | NMB | 1 5/8" | 1" |
| 10-21AF6NMC | 10,000 | 3/8" T.S. TO 3/8" NPT MALE | AF6 | NMC | 1 5/8" | 1" |
| 10-21AF6NMD | 10,000 | 3/8" T.S. TO 1/2" NPT MALE | AF6 | NMD | 1 3/4" | 1" |
| 10-21AF6NMF | 10,000 | 3/8" T.S. TO 3/4" NPT MALE | AF6 | NMF | 1 7/8" | 1 3/8" |
| 10-21AF6NMH | 10,000 | 3/8" T.S. TO 1" NPT MALE | AF6 | NMH | 1 7/8" | 1 3/8" |

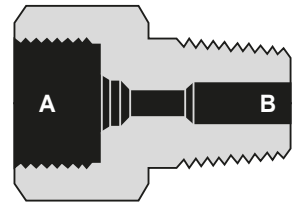

Female High Pressure to Male High Pressure

| Catalog No. | Pressure Rating psi | Connections | A | B | Length | Hex Size |
|-------------|---------------------|------------------------------|-----|-----|--------|----------|
| 60-21HF2HM4 | 60,000 | 1/8" O.D. TUBE TO 1/4" H.P. | HF2 | HM4 | 1 1/4" | 5/8" |
| 60-21HF2HM6 | 60,000 | 1/8" O.D. TUBE TO 3/8" H.P. | HF2 | HM6 | 1 3/4" | 3/4" |
| 60-21HF2HM9 | 60,000 | 1/8" O.D. TUBE TO 9/16" H.P. | HF2 | HM9 | 2 1/8" | 1 1/8" |
| 60-21HF4HM2 | 60,000 | 1/4" O.D. TUBE TO 1/8" H.P. | HF4 | HM2 | 1 3/8" | 3/4" |
| 60-21HF4HM6 | 60,000 | 1/4" O.D. TUBE TO 3/8" H.P. | HF4 | HM6 | 1 3/4" | 3/4" |
| 60-21HF4HM9 | 60,000 | 1/4" O.D. TUBE TO 9/16" H.P. | HF4 | HM9 | 2 1/8" | 1 1/8" |
| 60-21HF6HM2 | 60,000 | 1/4" O.D. TUBE TO 1/8" H.P. | HF6 | HM2 | 1 1/2" | 1" |
| 60-21HF6HM4 | 60,000 | 3/8" O.D. TUBE TO 1/4" H.P. | HF6 | HM4 | 1 1/2" | 1" |
| 60-21HF6HM9 | 60,000 | 3/8" O.D. TUBE TO 9/16" H.P. | HF6 | HM9 | 2 1/8" | 1 1/8" |
| 60-21HF9HM4 | 60,000 | 9/16" O.D. TUBE TO 1/4" H.P. | HF9 | HM4 | 1 3/4" | 1 3/8" |
| 60-21HF9HM6 | 60,000 | 9/16" O.D. TUBE TO 3/8" H.P. | HF9 | HM6 | 1 7/8" | 1 3/8" |

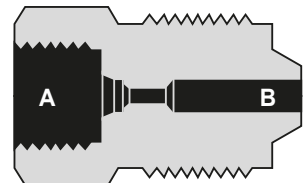



High Pressure Equipment

Female Medium Pressure to Male Medium Pressure

| Catalog No. | Pressure Rating psi | Connections | A | B | Length | Hex Size |
|---------------|---------------------|-------------------------------------|---------|------|--------|----------|
| 20-21LF4LM6 | 20,000 | 1/4" M.P. FEMALE to 3/8" M.P. MALE | LF4 | LM6 | 1 3/4" | 3/4" |
| 20-21LF4LM9 | 20,000 | 1/4" M.P. FEMALE to 9/16" M.P. MALE | LF4 | LM9 | 1 7/8" | 7/8" |
| 20-21LF6LM4 | 20,000 | 3/8" M.P. FEMALE to 1/4" M.P. MALE | LF6 | LM4 | 1 3/4" | 3/4" |
| 20-21LF6LM9 | 20,000 | 3/8" M.P. FEMALE to 9/16" M.P. MALE | LF6 | LM9 | 1 7/8" | 7/8" |
| 20-21LF9LM4 | 20,000 | 9/16" M.P. FEMALE to 1/4" M.P. MALE | LF9 | LM4 | 2 1/8" | 1" |
| 20-21LF9LM6 | 20,000 | 9/16" M.P. FEMALE to 3/8" M.P. MALE | LF9 | LM6 | 2 1/8" | 1" |
| 20-21LF12LM4 | 20,000 | 3/4" M.P. FEMALE to 1/4" M.P. MALE | LF12 | LM4 | 2 1/4" | 1 3/8" |
| 20-21LF12LM6 | 20,000 | 3/4" M.P. FEMALE to 3/8" M.P. MALE | LF12 | LM6 | 2 3/8" | 1 3/8" |
| 20-21LF12LM9 | 20,000 | 3/4" M.P. FEMALE to 9/16" M.P. MALE | LF12 | LM9 | 2 7/8" | 1 3/8" |
| 20-21LF12LM16 | 20,000 | 3/4" M.P. FEMALE to 1" M.P. MALE | LF12 | LM16 | 3 3/4" | 1 3/8" |
| 20-21LF4LM12 | 20,000 | 1/4" M.P. FEMALE to 3/4" M.P. MALE | LF4 | LM12 | 2" | 1 1/8" |
| 20-21LF6LM12 | 20,000 | 3/8" M.P. FEMALE to 3/4" M.P. MALE | LF6 | LM12 | 2" | 1 1/8" |
| 20-21LF9LM12 | 20,000 | 9/16" M.P. FEMALE to 3/4" M.P. MALE | LF9 | LM12 | 2 1/2" | 1 1/8" |
| 20-21LF16LM4 | 20,000 | 1" M.P. FEMALE to 1/4" M.P. MALE | LF16-30 | LM4 | 2 3/4" | 1 3/4" |
| 20-21LF16LM6 | 20,000 | 1" M.P. FEMALE to 3/8" M.P. MALE | LF16-30 | LM6 | 2 7/8" | 1 3/4" |
| 20-21LF16LM9 | 20,000 | 1" M.P. FEMALE to 9/16" M.P. MALE | LF16-30 | LM9 | 3" | 1 3/4" |
| 20-21LF16LM12 | 20,000 | 1" M.P. FEMALE to 3/4" M.P. MALE | LF16-30 | LM12 | 3 1/4" | 1 3/4" |
| 20-21LF4LM16 | 20,000 | 1/4" M.P. FEMALE to 1" M.P. MALE | LF4 | LM16 | 3" | 1" |
| 20-21LF6LM16 | 20,000 | 3/8" M.P. FEMALE to 1" M.P. MALE | LF6 | LM16 | 3 1/8" | 1" |
| 20-21LF9LM16 | 20,000 | 9/16" M.P. FEMALE to 1" M.P. MALE | LF9 | LM16 | 3 3/8" | 1" |

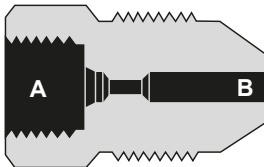

Female Medium Pressure to Male High Pressure

| Catalog No. | Pressure Rating psi | Connections | A | B | Length | Hex Size |
|----------------|---------------------|--------------------------------------|------|-----|--------|----------|
| 20-21LF4HM4 | 20,000 | 1/4" M.P. FEMALE to 1/4" H.P. MALE | LF4 | HM4 | 1 3/8" | 3/4" |
| 20-21LF4HM6 | 20,000 | 1/4" M.P. FEMALE to 3/8" H.P. MALE | LF4 | HM6 | 1 3/4" | 3/4" |
| 20-21LF4HM9 | 20,000 | 1/4" M.P. FEMALE to 9/16" H.P. MALE | LF4 | HM9 | 2 1/8" | 1 1/8" |
| 20-21LF6HM4 | 20,000 | 3/8" M.P. FEMALE to 1/4" H.P. MALE | LF6 | HM4 | 1 3/4" | 3/4" |
| 20-21LF6HM6 | 20,000 | 3/8" M.P. FEMALE to 3/8" H.P. MALE | LF6 | HM6 | 1 3/4" | 3/4" |
| 20-21LF6HM9 | 20,000 | 3/8" M.P. FEMALE to 9/16" H.P. MALE | LF6 | HM9 | 2 1/8" | 1 1/8" |
| 20-21LF9HM4 | 20,000 | 9/16" M.P. FEMALE to 1/4" H.P. MALE | LF9 | HM4 | 1 7/8" | 1" |
| 20-21LF9HM6 | 20,000 | 9/16" M.P. FEMALE to 3/8" H.P. MALE | LF9 | HM6 | 2 1/8" | 1" |
| 20-21LF9HM9 | 20,000 | 9/16" M.P. FEMALE to 9/16" H.P. MALE | LF9 | HM9 | 2 1/8" | 1 1/8" |
| 20-21LF12HM4 | 20,000 | 3/4" M.P. FEMALE to 1/4" H.P. MALE | LF12 | HM4 | 2 1/2" | 1 3/8" |
| 20-21LF12HM6 | 20,000 | 3/4" M.P. FEMALE to 3/8" H.P. MALE | LF12 | HM6 | 2 3/8" | 1 3/8" |
| 20-21LF12HM9 | 20,000 | 3/4" M.P. FEMALE to 9/16" H.P. MALE | LF12 | HM9 | 2 5/8" | 1 3/8" |
| * 20-21LF16HM4 | 20,000 | 1" M.P. FEMALE to 1/4" H.P. MALE | LF16 | HM4 | 2 5/8" | 1 3/4" |
| * 20-21LF16HM6 | 20,000 | 1" M.P. FEMALE to 3/8" H.P. MALE | LF16 | HM6 | 2 7/8" | 1 3/4" |
| * 20-21LF16HM9 | 20,000 | 1" M.P. FEMALE to 9/16" H.P. MALE | LF16 | HM9 | 3 1/8" | 1 3/4" |

* Can be rated to 30,000 psi if used with 1" O.D. x 7/16" I.D. tubing.

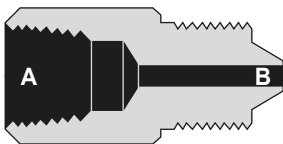

Female to Male Adapters

Female Medium Pressure to Male Pipe

| Catalog No. | Pressure Rating psi | Connections | A | B | Length | Hex Size |
|--------------|------------------------|------------------------------------|---------|-----|---------|----------|
| 20-21LF4NMA | 15,000 | 1/4" M.P. FEMALE to 1/8" NPT MALE | LF4 | NMA | 1 7/16" | 3/4" |
| 20-21LF4NMB | 15,000 | 1/4" M.P. FEMALE to 1/4" NPT MALE | LF4 | NMB | 1 5/8" | 3/4" |
| 20-21LF4NMC | 15,000 | 1/4" M.P. FEMALE to 3/8" NPT MALE | LF4 | NMC | 1 5/8" | 3/4" |
| 20-21LF4NMD | 15,000 | 1/4" M.P. FEMALE to 1/2" NPT MALE | LF4 | NMD | 1 3/4" | 1" |
| 10-21LF4NMF | 10,000 | 1/4" M.P. FEMALE to 3/4" NPT MALE | LF4 | NMF | 1 7/8" | 1 3/8" |
| 10-21LF4NMH | 10,000 | 1/4" M.P. FEMALE to 1" NPT MALE | LF4 | NMH | 1 7/8" | 1 3/8" |
| 20-21LF6NMA | 15,000 | 3/8" M.P. FEMALE to 1/8" NPT MALE | LF6 | NMA | 1 7/16" | 3/4" |
| 20-21LF6NMB | 15,000 | 3/8" M.P. FEMALE to 1/4" NPT MALE | LF6 | NMB | 1 5/8" | 3/4" |
| 20-21LF6NMC | 15,000 | 3/8" M.P. FEMALE to 3/8" NPT MALE | LF6 | NMC | 1 5/8" | 3/4" |
| 20-21LF6NMD | 15,000 | 3/8" M.P. FEMALE to 1/2" NPT MALE | LF6 | NMD | 1 3/4" | 1" |
| 10-21LF6NMF | 10,000 | 3/8" M.P. FEMALE to 3/4" NPT MALE | LF6 | NMF | 1 7/8" | 1 3/8" |
| 10-21LF6NMH | 10,000 | 3/8" M.P. FEMALE to 1" NPT MALE | LF6 | NMH | 1 7/8" | 1 3/8" |
| 20-21LF9NMA | 15,000 | 9/16" M.P. FEMALE to 1/8" NPT MALE | LF9 | NMA | 1 7/8" | 1" |
| 20-21LF9NMB | 15,000 | 9/16" M.P. FEMALE to 1/4" NPT MALE | LF9 | NMB | 1 7/8" | 1" |
| 20-21LF9NMC | 15,000 | 9/16" M.P. FEMALE to 3/8" NPT MALE | LF9 | NMC | 1 7/8" | 1" |
| 20-21LF9NMD | 15,000 | 9/16" M.P. FEMALE to 1/2" NPT MALE | LF9 | NMD | 1 7/8" | 1" |
| 10-21LF9NMF | 10,000 | 9/16" M.P. FEMALE to 3/4" NPT MALE | LF9 | NMF | 1 7/8" | 1 3/8" |
| 10-21LF9NMH | 10,000 | 9/16" M.P. FEMALE to 1" NPT MALE | LF9 | NMH | 1 7/8" | 1 3/8" |
| 20-21LF12NMA | 15,000 | 3/4" M.P. FEMALE to 1/8" NPT MALE | LF12 | NMA | 2 1/2" | 1 3/8" |
| 20-21LF12NMB | 15,000 | 3/4" M.P. FEMALE to 1/4" NPT MALE | LF12 | NMB | 2 1/2" | 1 3/8" |
| 20-21LF12NMC | 15,000 | 3/4" M.P. FEMALE to 3/8" NPT MALE | LF12 | NMC | 2 1/2" | 1 3/8" |
| 20-21LF12NMD | 15,000 | 3/4" M.P. FEMALE to 1/2" NPT MALE | LF12 | NMD | 2 1/2" | 1 3/8" |
| 10-21LF12NMF | 10,000 | 3/4" M.P. FEMALE to 3/4" NPT MALE | LF12 | NMF | 2 1/2" | 1 3/8" |
| 10-21LF12NMH | 10,000 | 3/4" M.P. FEMALE to 1" NPT MALE | LF12 | NMH | 2 1/2" | 1 3/8" |
| 20-21LF16NMA | 15,000 | 1" M.P. FEMALE to 1/8" NPT MALE | LF16-30 | NMA | 2 1/2" | 1 3/4" |
| 20-21LF16NMB | 15,000 | 1" M.P. FEMALE to 1/4" NPT MALE | LF16-30 | NMB | 2 1/2" | 1 3/4" |
| 20-21LF16NMC | 15,000 | 1" M.P. FEMALE to 3/8" NPT MALE | LF16-30 | NMC | 2 1/2" | 1 3/4" |
| 20-21LF16NMD | 15,000 | 1" M.P. FEMALE to 1/2" NPT MALE | LF16-30 | NMD | 2 1/2" | 1 3/4" |
| 10-21LF16NMF | 10,000 | 1" M.P. FEMALE to 3/4" NPT MALE | LF16-30 | NMF | 2 1/2" | 1 3/4" |
| 10-21LF16NMH | 10,000 | 1" M.P. FEMALE to 1" NPT MALE | LF16-30 | NMH | 2 1/2" | 1 3/4" |

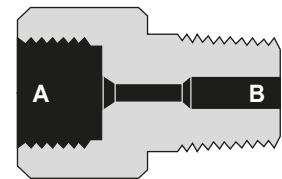



High Pressure Equipment

Female Pipe to Male High Pressure

| Catalog No. | Pressure Rating psi | Connections | A | B | Length | Hex Size |
|-------------|---------------------|-----------------------------|-----|-----|--------|----------|
| 30-21NFAHM2 | 15,000 | 1/8" NPT TO 1/8" H.P. MALE | NFA | HM2 | 1 5/8" | 3/4" |
| 30-21NFBHM2 | 15,000 | 1/4" NPT TO 1/8" H.P. MALE | NFB | HM2 | 1 5/8" | 3/4" |
| 30-21NFCM2 | 15,000 | 3/8" NPT TO 1/8" H.P. MALE | NFC | HM2 | 1 3/4" | 1" |
| 30-21NFAHM4 | 15,000 | 1/8" NPT TO 1/4" H.P. MALE | NFA | HM4 | 1 5/8" | 3/4" |
| 30-21NFBHM4 | 15,000 | 1/4" NPT TO 1/4" H.P. MALE | NFB | HM4 | 1 3/4" | 3/4" |
| 30-21NFCM4 | 15,000 | 3/8" NPT TO 1/4" H.P. MALE | NFC | HM4 | 1 3/4" | 1" |
| 30-21NFDHM4 | 15,000 | 1/2" NPT TO 1/4" H.P. MALE | NFD | HM4 | 2 1/8" | 1 1/8" |
| 30-21NFAHM6 | 15,000 | 1/8" NPT TO 3/8" H.P. MALE | NFA | HM6 | 1 5/8" | 3/4" |
| 30-21NFBHM6 | 15,000 | 1/4" NPT TO 3/8" H.P. MALE | NFB | HM6 | 1 3/4" | 3/4" |
| 30-21NFCM6 | 15,000 | 3/8" NPT TO 3/8" H.P. MALE | NFC | HM6 | 1 3/4" | 1" |
| 30-21NFDHM6 | 15,000 | 1/2" NPT TO 3/8" H.P. MALE | NFD | HM6 | 2 1/8" | 1 1/8" |
| 10-21NFFHM6 | 10,000 | 3/4" NPT TO 3/8" H.P. MALE | NFF | HM6 | 2 1/2" | 1 5/8" |
| 30-21NFAHM9 | 15,000 | 1/8" NPT TO 9/16" H.P. MALE | NFA | HM9 | 2 1/8" | 1 1/8" |
| 30-21NFBHM9 | 15,000 | 1/4" NPT TO 9/16" H.P. MALE | NFB | HM9 | 2 1/8" | 1 1/8" |
| 30-21NFCM9 | 15,000 | 3/8" NPT TO 9/16" H.P. MALE | NFC | HM9 | 2 1/8" | 1 1/8" |
| 30-21NFDHM9 | 15,000 | 1/2" NPT TO 9/16" H.P. MALE | NFD | HM9 | 2 1/8" | 1 1/8" |
| 10-21NFFHM9 | 10,000 | 3/4" NPT TO 9/16" H.P. MALE | NFF | HM9 | 2 1/4" | 1 3/8" |
| 10-21NFHHM9 | 10,000 | 1" NPT TO 9/16" H.P. MALE | NFH | HM9 | 2" | 1 7/8" |

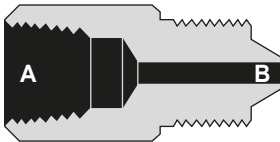

Female High Pressure to Male Medium Pressure

| Catalog No. | Pressure Rating psi | Connections | A | B | Length | Hex Size |
|--------------|---------------------|--------------------------------------|-----|---------|--------|----------|
| 20-21HF4LM4 | 20,000 | 1/4" H.P. FEMALE TO 1/4" M.P. MALE | HF4 | LM4 | 1 3/4" | 3/4" |
| 20-21HF4LM6 | 20,000 | 1/4" H.P. FEMALE TO 3/8" M.P. MALE | HF4 | LM6 | 1 3/4" | 3/4" |
| 20-21HF4LM9 | 20,000 | 1/4" H.P. FEMALE TO 9/16" M.P. MALE | HF4 | LM9 | 1 7/8" | 7/8" |
| 20-21HF6LM4 | 20,000 | 3/8" H.P. FEMALE TO 1/4" M.P. MALE | HF6 | LM4 | 1 7/8" | 1" |
| 20-21HF6LM6 | 20,000 | 3/8" H.P. FEMALE TO 3/8" M.P. MALE | HF6 | LM6 | 1 7/8" | 1" |
| 20-21HF6LM9 | 20,000 | 3/8" H.P. FEMALE TO 9/16" M.P. MALE | HF6 | LM9 | 2" | 1" |
| 20-21HF9LM4 | 20,000 | 9/16" H.P. FEMALE TO 1/4" M.P. MALE | HF9 | LM4 | 2 1/8" | 1 3/8" |
| 20-21HF9LM6 | 20,000 | 9/16" H.P. FEMALE TO 3/8" M.P. MALE | HF9 | LM6 | 2 1/8" | 1 3/8" |
| 20-21HF9LM9 | 20,000 | 9/16" H.P. FEMALE TO 9/16" M.P. MALE | HF9 | LM9 | 2 3/8" | 1 3/8" |
| 20-21HF4LM12 | 20,000 | 1/4" H.P. FEMALE TO 3/4" M.P. MALE | HF4 | LM12 | 2 1/4" | 1 1/8" |
| 20-21HF6LM12 | 20,000 | 3/8" H.P. FEMALE TO 3/4" M.P. MALE | HF6 | LM12 | 2 1/4" | 1 1/8" |
| 20-21HF9LM12 | 20,000 | 9/16" H.P. FEMALE TO 3/4" M.P. MALE | HF9 | LM12 | 2 1/2" | 1 3/8" |
| 20-21HF4LM16 | 20,000 | 1/4" H.P. FEMALE TO 1" M.P. MALE | HF4 | LM16 | 3" | 1" |
| 20-21HF6LM16 | 20,000 | 3/8" H.P. FEMALE TO 1" M.P. MALE | HF6 | LM16 | 3 1/4" | 1" |
| 20-21HF9LM16 | 20,000 | 9/16" H.P. FEMALE TO 1" M.P. MALE | HF9 | LM16 | 3 3/8" | 1 3/8" |
| 20-21HF4LM16 | 20,000 | 1/4" H.P. FEMALE TO 1" M.P. MALE | HF4 | LM16-30 | 3" | 1" |
| 20-21HF6LM16 | 20,000 | 3/8" H.P. FEMALE TO 1" M.P. MALE | HF6 | LM16-30 | 3 1/4" | 1" |
| 20-21HF9LM16 | 20,000 | 9/16" H.P. FEMALE TO 1" M.P. MALE | HF9 | LM16-30 | 3 3/8" | 1 3/8" |

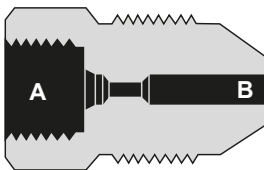

Female to Male Adapters

Female High Pressure to Male Pipe

| Catalog No. | Pressure Rating psi | Connections | A | B | Length | Hex Size |
|-------------|---------------------|-----------------------------|-----|-----|--------|----------|
| 30-21HF2NMA | 15,000 | 1/8" H.P. TO 1/8" NPT MALE | HF2 | NMA | 1 1/4" | 5/8" |
| 30-21HF2NMB | 15,000 | 1/8" H.P. TO 1/4" NPT MALE | HF2 | NMB | 1 1/4" | 5/8" |
| 30-21HF2NMC | 15,000 | 1/8" H.P. TO 3/8" NPT MALE | HF2 | NMC | 1 3/8" | 3/4" |
| 30-21HF2NMD | 15,000 | 1/8" H.P. TO 1/2" NPT MALE | HF2 | NMD | 1 1/2" | 1" |
| 10-21HF2NMF | 10,000 | 1/8" H.P. TO 3/4" NPT MALE | HF2 | NMF | 1 3/4" | 1 3/8" |
| 10-21HF2NMH | 10,000 | 1/8" H.P. TO 1" NPT MALE | HF2 | NMH | 1 3/4" | 1 3/8" |
| 30-21HF4NMA | 15,000 | 1/4" H.P. TO 1/8" NPT MALE | HF4 | NMA | 1 1/4" | 3/4" |
| 30-21HF4NMB | 15,000 | 1/4" H.P. TO 1/4" NPT MALE | HF4 | NMB | 1 3/8" | 3/4" |
| 30-21HF4NMC | 15,000 | 1/4" H.P. TO 3/8" NPT MALE | HF4 | NMC | 1 3/8" | 3/4" |
| 30-21HF4NMD | 15,000 | 1/4" H.P. TO 1/2" NPT MALE | HF4 | NMD | 1 3/4" | 1" |
| 10-21HF4NMF | 10,000 | 1/4" H.P. TO 3/4" NPT MALE | HF4 | NMF | 1 3/4" | 1 3/8" |
| 10-21HF4NMH | 10,000 | 1/4" H.P. TO 1" NPT MALE | HF4 | NMH | 1 5/8" | 1 3/8" |
| 30-21HF6NMA | 15,000 | 3/8" H.P. TO 1/8" NPT MALE | HF6 | NMA | 1 1/2" | 1" |
| 30-21HF6NMB | 15,000 | 3/8" H.P. TO 1/4" NPT MALE | HF6 | NMB | 1 5/8" | 1" |
| 30-21HF6NMC | 15,000 | 3/8" H.P. TO 3/8" NPT MALE | HF6 | NMC | 1 5/8" | 1" |
| 30-21HF6NMD | 15,000 | 3/8" H.P. TO 1/2" NPT MALE | HF6 | NMD | 1 3/4" | 1" |
| 10-21HF6NMF | 10,000 | 3/8" H.P. TO 3/4" NPT MALE | HF6 | NMF | 1 7/8" | 1 3/8" |
| 10-21HF6NMH | 10,000 | 3/8" H.P. TO 1" NPT MALE | HF6 | NMH | 1 7/8" | 1 3/8" |
| 30-21HF9NMA | 15,000 | 9/16" H.P. TO 1/8" NPT MALE | HF9 | NMA | 1 1/2" | 1 3/8" |
| 30-21HF9NMB | 15,000 | 9/16" H.P. TO 1/4" NPT MALE | HF9 | NMB | 1 5/8" | 1 3/8" |
| 30-21HF9NMC | 15,000 | 9/16" H.P. TO 3/8" NPT MALE | HF9 | NMC | 1 3/4" | 1 3/8" |
| 30-21HF9NMD | 15,000 | 9/16" H.P. TO 1/2" NPT MALE | HF9 | NMD | 1 7/8" | 1 3/8" |
| 10-21HF9NMF | 10,000 | 9/16" H.P. TO 3/4" NPT MALE | HF9 | NMF | 1 7/8" | 1 3/8" |
| 10-21HF9NMH | 10,000 | 9/16" H.P. TO 1" NPT MALE | HF9 | NMH | 2" | 1 3/8" |

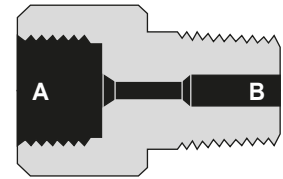

Female Pipe to Male Taper Seal

| Catalog No. | Pressure Rating psi | Connections | A | B | Hex Length | Size |
|-------------|---------------------|-----------------------------|-----|-----|------------|--------|
| 15-21NFAAM2 | 15,000 | 1/8" FNPT TO 1/8" MALE T.S. | NFA | AM2 | 1 1/2" | 5/8" |
| 15-21NFBAM2 | 15,000 | 1/4" FNPT TO 1/8" MALE T.S. | NFB | AM2 | 1 5/8" | 3/4" |
| 15-21NFCAM2 | 15,000 | 3/8" FNPT TO 1/8" MALE T.S. | NFC | AM2 | 1 3/4" | 1" |
| 10-21NFAAM4 | 10,000 | 1/8" FNPT TO 1/4" MALE T.S. | NFA | AM4 | 1 3/4" | 7/8" |
| 10-21NFBAM4 | 10,000 | 1/4" FNPT TO 1/4" MALE T.S. | NFB | AM4 | 1 3/4" | 1" |
| 10-21NFCAM4 | 10,000 | 3/8" FNPT TO 1/4" MALE T.S. | NFC | AM4 | 1 3/4" | 1" |
| 10-21NFDAM4 | 10,000 | 1/2" FNPT TO 1/4" MALE T.S. | NFD | AM4 | 2 1/8" | 1 1/8" |
| 10-21NFAAM6 | 10,000 | 1/8" FNPT TO 3/8" MALE T.S. | NFA | AM6 | 2" | 1" |
| 10-21NFBAM6 | 10,000 | 1/4" FNPT TO 3/8" MALE T.S. | NFB | AM6 | 2" | 1" |
| 10-21NFCAM6 | 10,000 | 3/8" FNPT TO 3/8" MALE T.S. | NFC | AM6 | 2" | 1" |
| 10-21NFDAM6 | 10,000 | 1/2" FNPT TO 3/8" MALE T.S. | NFD | AM6 | 2 1/8" | 1 1/8" |

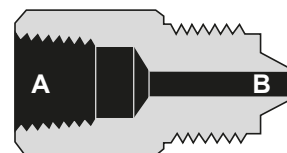



High Pressure Equipment

Female Pipe to Male Medium Pressure

| Catalog No. | Pressure Rating psi | Connections | A | B | Length | Hex Size |
|--------------|---------------------|---------------------------------------|-----|------|--------|----------|
| 20-21NFALM4 | 15,000 | 1/8" N.P.T. FEMALE to 1/4" M.P. MALE | NFA | LM4 | 1 3/4" | 3/4" |
| 20-21NFBLM4 | 15,000 | 1/4" N.P.T. FEMALE to 1/4" M.P. MALE | NFB | LM4 | 1 3/4" | 3/4" |
| 20-21NFCLM4 | 15,000 | 3/8" N.P.T. FEMALE to 1/4" M.P. MALE | NFC | LM4 | 2" | 1" |
| 20-21NFDLM4 | 15,000 | 1/2" N.P.T. FEMALE to 1/4" M.P. MALE | NFD | LM4 | 2 1/8" | 1 1/8" |
| 10-21NFFLM4 | 10,000 | 3/4" N.P.T. FEMALE to 1/4" M.P. MALE | NFF | LM4 | 2 3/8" | 1 3/8" |
| 20-21NFALM6 | 15,000 | 1/8" N.P.T. FEMALE to 3/8" M.P. MALE | NFA | LM6 | 1 7/8" | 3/4" |
| 20-21NFBLM6 | 15,000 | 1/4" N.P.T. FEMALE to 3/8" M.P. MALE | NFB | LM6 | 1 7/8" | 3/4" |
| 20-21NFCLM6 | 15,000 | 3/8" N.P.T. FEMALE to 3/8" M.P. MALE | NFC | LM6 | 2 1/8" | 1" |
| 20-21NFDLM6 | 15,000 | 1/2" N.P.T. FEMALE to 3/8" M.P. MALE | NFD | LM6 | 2 1/4" | 1 1/8" |
| 10-21NFFLM6 | 10,000 | 3/4" N.P.T. FEMALE to 3/8" M.P. MALE | NFF | LM6 | 2 1/2" | 1 3/8" |
| 10-21NFHLM6 | 10,000 | 1" N.P.T. FEMALE to 3/8" M.P. MALE | NFH | LM6 | 2 7/8" | 1 7/8" |
| 20-21NFALM9 | 15,000 | 1/8" N.P.T. FEMALE to 9/16" M.P. MALE | NFA | LM9 | 1 7/8" | 7/8" |
| 20-21NFBLM9 | 15,000 | 1/4" N.P.T. FEMALE to 9/16" M.P. MALE | NFB | LM9 | 1 7/8" | 7/8" |
| 20-21NFCLM9 | 15,000 | 3/8" N.P.T. FEMALE to 9/16" M.P. MALE | NFC | LM9 | 2 1/4" | 1" |
| 20-21NFDLM9 | 15,000 | 1/2" N.P.T. FEMALE to 9/16" M.P. MALE | NFD | LM9 | 2 3/8" | 1 1/8" |
| 10-21NFFLM9 | 10,000 | 3/4" N.P.T. FEMALE to 9/16" M.P. MALE | NFF | LM9 | 2 5/8" | 1 3/8" |
| 10-21NFHLM9 | 10,000 | 1" N.P.T. FEMALE to 9/16" M.P. MALE | NFH | LM9 | 3" | 1 7/8" |
| 20-21NFALM12 | 15,000 | 1/8" N.P.T. FEMALE to 3/4" M.P. MALE | NFA | LM12 | 2" | 1 1/8" |
| 20-21NFBLM12 | 15,000 | 1/4" N.P.T. FEMALE to 3/4" M.P. MALE | NFB | LM12 | 2" | 1 1/8" |
| 20-21NFCLM12 | 15,000 | 3/8" N.P.T. FEMALE to 3/4" M.P. MALE | NFC | LM12 | 2" | 1 1/8" |
| 20-21NFDLM12 | 15,000 | 1/2" N.P.T. FEMALE to 3/4" M.P. MALE | NFD | LM12 | 2 1/2" | 1 1/8" |
| 10-21NFFLM12 | 10,000 | 3/4" N.P.T. FEMALE to 3/4" M.P. MALE | NFF | LM12 | 2 3/4" | 1 1/2" |
| 10-21NFHLM12 | 10,000 | 1" N.P.T. FEMALE to 3/4" M.P. MALE | NFH | LM12 | 3" | 1 7/8" |
| 20-21NFALM16 | 15,000 | 1/8" N.P.T. FEMALE to 1" M.P. MALE | NFA | LM16 | 3" | 1" |
| 20-21NFBLM16 | 15,000 | 1/4" N.P.T. FEMALE to 1" M.P. MALE | NFB | LM16 | 3" | 1" |
| 20-21NFCLM16 | 15,000 | 3/8" N.P.T. FEMALE to 1" M.P. MALE | NFC | LM16 | 3" | 1" |
| 20-21NFDLM16 | 15,000 | 1/2" N.P.T. FEMALE to 1" M.P. MALE | NFD | LM16 | 3 3/4" | 1 1/8" |
| 10-21NFFLM16 | 10,000 | 3/4" N.P.T. FEMALE to 1" M.P. MALE | NFF | LM16 | 4 1/8" | 1 1/2" |
| 10-21NFHLM16 | 10,000 | 1" N.P.T. FEMALE to 1" M.P. MALE | NFH | LM16 | 4 3/8" | 1 7/8" |

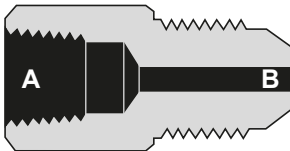

Male to Male Adapters

Adapters: Male to Male

Male to Male Adapters are available in the most commonly used sizes as listed below. These adapters permit the user to convert female connections to male connections, and are especially useful in confined installations or where rigidity is required. **Standard material** is high tensile Type 316 stainless steel.



Male Taper Seal to Male Taper Seal

| Catalog No. | Pressure Rating psi | Connections | A | B | Length | Hex Size |
|-------------|---------------------|--------------------------|-----|-----|--------|----------|
| 15-21AM1AM1 | 15,000 | 1/16" T.S. to 1/16" T.S. | AM1 | AM1 | 1 3/8" | 1/2" |
| 15-21AM2AM2 | 15,000 | 1/8" T.S. to 1/8" T.S. | AM2 | AM2 | 1 5/8" | 5/8" |
| 10-21AM2AM4 | 10,000 | 1/8" T.S. to 1/4" T.S. | AM2 | AM4 | 1 7/8" | 7/8" |
| 10-21AM4AM4 | 10,000 | 1/4" T.S. to 1/4" T.S. | AM4 | AM4 | 2 1/8" | 7/8" |
| 10-21AM4AM6 | 10,000 | 1/4" T.S. to 3/8" T.S. | AM4 | AM6 | 2 1/8" | 3/4" |
| 10-21AM6AM6 | 10,000 | 3/8" T.S. to 3/8" T.S. | AM6 | AM6 | 2 1/8" | 3/4" |

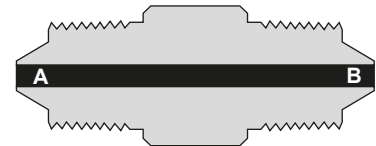

Male Taper Seal to Male Medium Pressure

| Catalog No. | Pressure Rating psi | Connections | A | B | Length | Hex Size |
|-------------|---------------------|-------------------------|-----|-----|---------|----------|
| 10-21AM4LM4 | 10,000 | 1/4" T.S. to 1/4" M.P. | AM4 | LM4 | 2 1/8" | 7/8" |
| 10-21AM4LM6 | 10,000 | 1/4" T.S. to 3/8" M.P. | AM4 | LM6 | 2 3/16" | 7/8" |
| 10-21AM4LM9 | 10,000 | 1/4" T.S. to 9/16" M.P. | AM4 | LM9 | 2 3/8" | 7/8" |
| 10-21AM6LM4 | 10,000 | 3/8" T.S. to 1/4" M.P. | AM6 | LM4 | 2 1/8" | 7/8" |
| 10-21AM6LM6 | 10,000 | 3/8" T.S. to 3/8" M.P. | AM6 | LM6 | 2 3/16" | 7/8" |
| 10-21AM6LM9 | 10,000 | 3/8" T.S. to 9/16" M.P. | AM6 | LM9 | 2 3/8" | 7/8" |
| 15-21AM2LM4 | 15,000 | 1/8" T.S. to 1/4" M.P. | AM2 | LM4 | 1 7/8" | 1/2" |
| 15-21AM2LM6 | 15,000 | 1/8" T.S. to 3/8" M.P. | AM2 | LM6 | 2" | 5/8" |
| 15-21AM2LM9 | 15,000 | 1/8" T.S. to 9/16" M.P. | AM2 | LM9 | 2 1/8" | 7/8" |

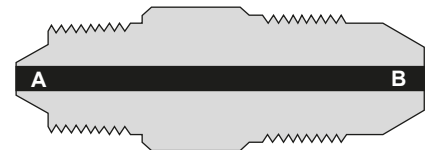

Male Taper Seal to Male Pipe

| Catalog No. | Pressure Rating psi | Connections | A | B | Length | Hex Size |
|-------------|---------------------|-----------------------------|-----|-----|---------|----------|
| 15-21AM1NMA | 15,000 | 1/16" T.S. to 1/8" NPT MALE | AM1 | NMA | 1 7/16" | 1/2" |
| 15-21AM1NMB | 15,000 | 1/16" T.S. to 1/4" NPT MALE | AM1 | NMB | 1 9/16" | 5/8" |
| 15-21AM2NMA | 15,000 | 1/8" T.S. to 1/8" NPT MALE | AM2 | NMA | 1 5/8" | 1/2" |
| 15-21AM2NMB | 15,000 | 1/8" T.S. to 1/4" NPT MALE | AM2 | NMB | 1 3/4" | 5/8" |
| 15-21AM4NMB | 15,000 | 1/4" T.S. to 1/4" NPT MALE | AM4 | NMB | 2" | 3/4" |

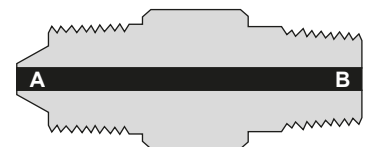



High Pressure Equipment

Male Taper Seal to Male High Pressure

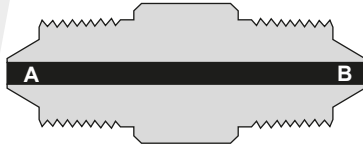

| Catalog No. | Pressure Rating psi | Connections | A | B | Length | Hex Size |
|-------------|---------------------|------------------------|-----|-----|---------|----------|
| 15-21AM2HM2 | 15,000 | 1/8" T.S. to 1/8" H.P. | AM2 | HM2 | 1 9/16" | 5/8" |
| 15-21AM2HM4 | 15,000 | 1/8" T.S. to 1/4" H.P. | AM2 | HM4 | 1 5/8" | 3/4" |
| 10-21AM4HM4 | 10,000 | 1/4" T.S. to 1/4" H.P. | AM4 | HM4 | 2" | 3/4" |

Male Medium Pressure to Male High Pressure

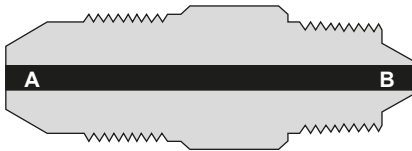

| Catalog No. | Pressure Rating psi | Connections | A | B | Length | Hex Size |
|-------------|---------------------|--------------------------|-----|-----|--------|----------|
| 20-21LM4HM2 | 20,000 | 1/4" M.P. to 1/8" H.P. | LM4 | HM2 | 1 7/8" | 5/8" |
| 20-21LM4HM9 | 20,000 | 1/4" M.P. to 9/16" H.P. | LM4 | HM9 | 2 3/8" | 1 1/8" |
| 20-21LM9HM4 | 20,000 | 9/16" M.P. to 1/4" H.P. | LM9 | HM4 | 2 1/4" | 7/8" |
| 20-21LM9HM9 | 20,000 | 9/16" M.P. to 9/16" H.P. | LM9 | HM9 | 2 3/8" | 1 1/8" |
| 20-21LM6HM4 | 20,000 | 3/8" M.P. to 1/4" H.P. | LM6 | HM4 | 2 1/8" | 5/8" |
| 20-21LM6HM9 | 20,000 | 3/8" M.P. to 9/16" H.P. | LM6 | HM9 | 2 1/2" | 1 1/8" |

Male Medium Pressure to Male Pipe (NPT)

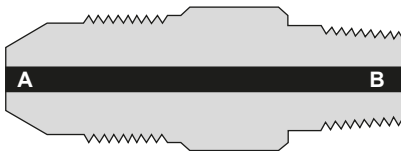

| Catalog No. | Pressure Rating psi | Connections | A | B | Length | Hex Size |
|--------------|---------------------|-----------------------------|------|-----|---------|----------|
| 20-21LM4NMB | 15,000 | 1/4" M.P. to 1/4" NPT MALE | LM4 | NMB | 2" | 5/8" |
| 20-21LM4NMD | 15,000 | 1/4" M.P. to 1/2" NPT MALE | LM4 | NMD | 2 1/8" | 7/8" |
| 20-21LM6NMB | 15,000 | 3/8" M.P. to 1/4" NPT MALE | LM6 | NMB | 2 1/16" | 3/4" |
| 20-21LM6NMC | 15,000 | 3/8" M.P. to 3/8" NPT MALE | LM6 | NMC | 2 1/16" | 3/4" |
| 20-21LM6NMD | 15,000 | 3/8" M.P. to 1/2" NPT MALE | LM6 | NMD | 2 3/16" | 7/8" |
| 20-21LM9NMA | 15,000 | 9/16" M.P. to 1/8" NPT MALE | LM9 | NMA | 2 1/8" | 7/8" |
| 20-21LM9NMB | 15,000 | 9/16" M.P. to 1/4" NPT MALE | LM9 | NMB | 2 1/4" | 7/8" |
| 20-21LM9NMC | 15,000 | 9/16" M.P. to 3/8" NPT MALE | LM9 | NMC | 2 1/4" | 7/8" |
| 20-21LM9NMD | 15,000 | 9/16" M.P. to 1/2" NPT MALE | LM9 | NMD | 2 3/8" | 7/8" |
| 10-21LM9NMF | 10,000 | 9/16" M.P. to 3/4" NPT MALE | LM9 | NMF | 2 5/8" | 1 1/8" |
| 10-21LM9NMH | 10,000 | 9/16" M.P. to 1" NPT MALE | LM9 | NMH | 2 5/8" | 1 3/8" |
| 20-21LM12NMA | 15,000 | 3/4" M.P. to 1/8" NPT MALE | LM12 | NMA | 2 3/8" | 1 1/8" |
| 20-21LM12NMB | 15,000 | 3/4" M.P. to 1/4" NPT MALE | LM12 | NMB | 2 1/2" | 1 1/8" |
| 20-21LM12NMC | 15,000 | 3/4" M.P. to 3/8" NPT MALE | LM12 | NMC | 2 1/2" | 1 1/8" |
| 20-21LM12NMD | 15,000 | 3/4" M.P. to 1/2" NPT MALE | LM12 | NMD | 2 5/8" | 1 1/8" |
| 10-21LM12NMF | 10,000 | 3/4" M.P. to 3/4" NPT MALE | LM12 | NMF | 2 3/4" | 1 1/8" |
| 10-21LM12NMH | 10,000 | 3/4" M.P. to 1" NPT MALE | LM12 | NMH | 3" | 1 3/8" |
| 20-21LM16NMA | 15,000 | 1" M.P. to 1/8" NPT MALE | LM16 | NMA | 3 5/8" | 1" |
| 20-21LM16NMB | 15,000 | 1" M.P. to 1/4" NPT MALE | LM16 | NMB | 3 3/4" | 1" |
| 20-21LM16NMC | 15,000 | 1" M.P. to 3/8" NPT MALE | LM16 | NMC | 3 3/4" | 1" |
| 20-21LM16NMD | 15,000 | 1" M.P. to 1/2" NPT MALE | LM16 | NMD | 3 7/8" | 1" |
| 10-21LM16NMF | 10,000 | 1" M.P. to 3/4" NPT MALE | LM16 | NMF | 3 7/8" | 1 1/8" |
| 10-21LM16NMH | 10,000 | 1" M.P. to 1" NPT MALE | LM16 | NMH | 4" | 1 3/8" |

Male to Male Adapters

Male Medium Pressure to Male Medium Pressure

| Catalog No. | Pressure Rating psi | Connections | A | B | Length | Hex Size |
|---------------|---------------------|--------------------------|------|------|--------|----------|
| 20-21LM4LM4 | 20,000 | 1/4" M.P. to 1/4" M.P. | LM4 | LM4 | 2" | 5/8" |
| 20-21LM4LM6 | 20,000 | 1/4" M.P. to 3/8" M.P. | LM4 | LM4 | 2 1/8" | 3/4" |
| 20-21LM6LM6 | 20,000 | 3/8" M.P. to 3/8" M.P. | LM6 | LM6 | 2 1/4" | 3/4" |
| 20-21LM6LM9 | 20,000 | 3/8" M.P. to 9/16" M.P. | LM6 | LM9 | 2 1/2" | 7/8" |
| 20-21LM9LM9 | 20,000 | 9/16" M.P. to 9/16" M.P. | LM9 | LM9 | 2 5/8" | 7/8" |
| 20-21LM4LM12 | 20,000 | 1/4" M.P. to 3/4" M.P. | LM4 | LM12 | 2 1/2" | 1 1/8" |
| 20-21LM6LM12 | 20,000 | 3/8" M.P. to 3/4" M.P. | LM6 | LM12 | 2 5/8" | 1 1/8" |
| 20-21LM9LM12 | 20,000 | 9/16" M.P. to 3/4" M.P. | LM9 | LM12 | 2 7/8" | 1 1/8" |
| 20-21LM4LM16 | 20,000 | 1/4" M.P. to 1" M.P. | LM4 | LM16 | 3 5/8" | 1" |
| 20-21LM6LM16 | 20,000 | 3/8" M.P. to 1" M.P. | LM6 | LM16 | 3 3/4" | 1" |
| 20-21LM9LM16 | 20,000 | 9/16" M.P. to 1" M.P. | LM9 | LM16 | 4" | 1" |
| 20-21LM12LM12 | 20,000 | 3/4" M.P. to 3/4" M.P. | LM12 | LM12 | 3" | 1 1/8" |
| 20-21LM12LM16 | 20,000 | 3/4" M.P. to 1" M.P. | LM12 | LM16 | 3 1/8" | 1 1/8" |

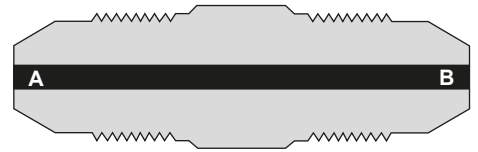

Male High Pressure to Male Pipe (NPT)

| Catalog No. | Pressure Rating psi | Connections | A | B | Length | Hex Size |
|-------------|---------------------|-----------------------------|-----|-----|--------|----------|
| 30-21HM2NMA | 15,000 | 1/8" H.P. to 1/8" NPT MALE | HM2 | NMA | 1 5/8" | 1/2" |
| 30-21HM2NMB | 15,000 | 1/8" H.P. to 1/4" NPT MALE | HM2 | NMB | 1 3/4" | 5/8" |
| 30-21HM4NMA | 15,000 | 1/4" H.P. to 1/8" NPT MALE | HM4 | NMA | 1 7/8" | 5/8" |
| 30-21HM4NMB | 15,000 | 1/4" H.P. to 1/4" NPT MALE | HM4 | NMB | 2" | 5/8" |
| 30-21HM4NMC | 15,000 | 1/4" H.P. to 3/8" NPT MALE | HM4 | NMC | 2" | 3/4" |
| 30-21HM4NMD | 15,000 | 1/4" H.P. to 1/2" NPT MALE | HM4 | NMD | 2 1/8" | 7/8" |
| 10-21HM4NMF | 10,000 | 1/4" H.P. to 3/4" NPT MALE | HM4 | NMF | 2 1/4" | 1 1/8" |
| 30-21HM6NMB | 15,000 | 3/8" H.P. to 1/4" NPT MALE | HM6 | NMB | 2 1/8" | 7/8" |
| 30-21HM6NMC | 15,000 | 3/8" H.P. to 3/8" NPT MALE | HM6 | NMC | 2 1/8" | 7/8" |
| 30-21HM9NMB | 15,000 | 9/16" H.P. to 1/4" NPT MALE | HM9 | NMB | 2 3/8" | 1 1/8" |
| 30-21HM9NMC | 15,000 | 9/16" H.P. to 3/8" NPT MALE | HM9 | NMC | 2 3/8" | 1 1/8" |
| 30-21HM9NMD | 15,000 | 9/16" H.P. to 1/2" NPT MALE | HM9 | NMD | 2 1/2" | 1 1/8" |
| 10-21HM9NMF | 10,000 | 9/16" H.P. to 3/4" NPT MALE | HM9 | NMF | 2 5/8" | 1 1/8" |
| 10-21HM9NMH | 10,000 | 9/16" H.P. to 1" NPT MALE | HM9 | NMH | 2 3/4" | 1 3/8" |

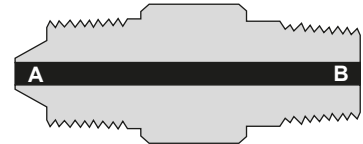

Male Pipe to Male Pipe

| Catalog No. | Pressure Rating psi | Connections | A | B | Length | Hex Size |
|-------------|---------------------|--------------------------------|-----|-----|--------|----------|
| 15-21NMBNMB | 15,000 | 1/4" NPT MALE to 1/4" NPT MALE | NMB | NMB | 1 7/8" | 5/8" |
| 15-21NMBNMC | 15,000 | 1/4" NPT MALE to 3/8" NPT MALE | NMB | NMB | 2" | 3/4" |
| 15-21NMCNMC | 15,000 | 3/8" NPT MALE to 3/8" NPT MALE | NMC | NMC | 2" | 3/4" |
| 15-21NMDNMD | 15,000 | 1/2" NPT MALE to 1/2" NPT MALE | NMD | NMD | 2 1/8" | 1" |

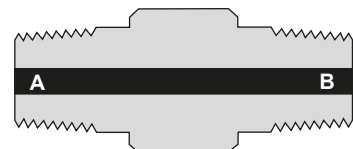



High Pressure Equipment

Male High Pressure to Male Medium Pressure

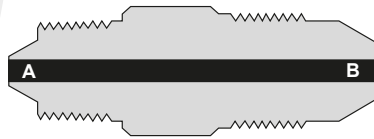

| Catalog No. | Pressure Rating psi | Connections | A | B | Length | Hex Size |
|--------------|---------------------|-------------------------|-----|------|--------|----------|
| 20-21HM4LM12 | 20,000 | 1/4" H.P. to 3/4" M.P. | HM4 | LM12 | 2 5/8" | 1 1/8" |
| 20-21HM6LM12 | 20,000 | 3/8" H.P. to 3/4" M.P. | HM6 | LM12 | 2 3/4" | 1 1/8" |
| 20-21HM9LM12 | 20,000 | 9/16" H.P. to 3/4" M.P. | HM9 | LM12 | 3" | 1 1/8" |
| 20-21HM4LM16 | 20,000 | 1/4" H.P. to 1" M.P. | HM4 | LM16 | 3 5/8" | 1" |
| 20-21HM6LM16 | 20,000 | 3/8" H.P. to 1" M.P. | HM6 | LM16 | 4" | 1" |
| 20-21HM9LM16 | 20,000 | 9/16" H.P. to 1" M.P. | HM9 | LM16 | 4" | 1 1/8" |

Male High Pressure to Male High Pressure

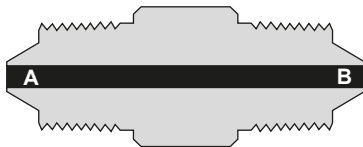

| Catalog No. | Pressure Rating psi | Connections | A | B | Length | Hex Size |
|--------------|---------------------|--------------------------|-----|------|----------|----------|
| 60-21HM2HM2 | 60,000 | 1/8" H.P. to 1/8" H.P. | HM2 | HM2 | 1 1/2" | 1/2" |
| 60-21HM2HM4 | 60,000 | 1/8" H.P. to 1/4" H.P. | HM2 | HM4 | 1 5/8" | 5/8" |
| 60-21HM4HM4 | 60,000 | 1/4" H.P. to 1/4" H.P. | HM4 | HM4 | 1 11/16" | 5/8" |
| 60-21HM4HM6 | 60,000 | 1/4" H.P. to 3/8" H.P. | HM4 | HM6 | 2 1/16" | 3/4" |
| 60-21HM4HM9 | 60,000 | 1/4" H.P. to 9/16" H.P. | HM4 | HM9 | 2 1/4" | 1 1/8" |
| 60-21HM6HM6 | 60,000 | 3/8" H.P. to 3/8" H.P. | HM6 | HM6 | 2 1/4" | 3/4" |
| 60-21HM6HM9 | 60,000 | 3/8" H.P. to 9/16" H.P. | HM6 | HM9 | 2 1/2" | 1 1/8" |
| 60-21HM9HM9 | 60,000 | 9/16" H.P. to 9/16" H.P. | HM9 | HM9 | 2 5/8" | 1 1/8" |
| 30-21HM4HM16 | 30,000 | 1/4" H.P. to 1" M.P. | HM4 | HM16 | 3 5/8" | 1" |
| 30-21HM6HM16 | 30,000 | 3/8" H.P. to 1" M.P. | HM6 | HM16 | 4" | 1" |
| 30-21HM9HM16 | 30,000 | 9/16" H.P. to 1" M.P. | HM9 | HM16 | 4" | 1 1/8" |

NPT Fittings

A complete line of couplings and adapters with NPT threaded connections are now available. These fittings feature 316 cold-worked stainless steel construction, with other materials available. HiP maintains an inventory of these fittings for quick ship requirements.



NPT Straight Couplings

| Catalog No. | Pressure Rating psi | Connections | A | B | Length | Hex Size |
|-------------|---------------------|-----------------------------------|-----|-----|--------|----------|
| 15-21NFA | 15,000 | 1/8" FEMALE NPT x 1/8" FEMALE NPT | NFA | NFA | 1 1/4" | 3/4" |
| 15-21NFB | 15,000 | 1/4" FEMALE NPT x 1/4" FEMALE NPT | NFB | NFB | 1 3/4" | 1" |
| 15-21NFC | 15,000 | 3/8" FEMALE NPT x 3/8" FEMALE NPT | NFC | NFC | 1 3/8" | 1" |
| 15-21NFD | 15,000 | 1/2" FEMALE NPT x 1/2" FEMALE NPT | NFD | NFD | 1 7/8" | 1 3/8" |
| 10-21NFF | 10,000 | 3/4" FEMALE NPT x 3/4" FEMALE NPT | NFF | NFF | 2 1/2" | 1 3/8" |
| 10-21NFH | 10,000 | 1" FEMALE NPT x 1" FEMALE NPT | NFH | NFH | 2 1/2" | 1 3/4" |

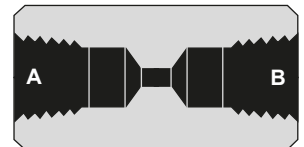

NPT Reducer Couplings

| Catalog No. | Pressure Rating psi | Connections | A | B | Length | Hex Size |
|-------------|---------------------|-----------------------------------|-----|-----|--------|----------|
| 15-21NFBNFC | 15,000 | 1/4" FEMALE NPT x 3/8" FEMALE NPT | NFB | NFC | 1 1/2" | 1" |
| 15-21NFBNFD | 15,000 | 1/4" FEMALE NPT x 1/2" FEMALE NPT | NFB | NFD | 2" | 1 3/8" |
| 15-21NFCNFD | 15,000 | 3/8" FEMALE NPT x 1/2" FEMALE NPT | NFC | NFD | 2" | 1 3/8" |

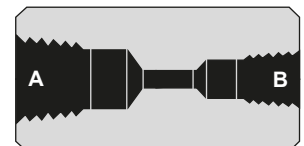

Adapters: Male to Male NPT

| Catalog No. | Pressure Rating psi | Connections | A | B | Length | Hex Size |
|-------------|---------------------|-------------------------------|-----|-----|--------|----------|
| 15-21NMANMA | 15,000 | 1/8" MALE NPT x 1/8" MALE NPT | NMA | NMA | 1 3/4" | 1/2" |
| 15-21NMBNMB | 15,000 | 1/4" MALE NPT x 1/4" MALE NPT | NMB | NMB | 1 7/8" | 5/8" |
| 15-21NMCNMC | 15,000 | 3/8" MALE NPT x 3/8" MALE NPT | NMC | NMC | 2" | 3/4" |
| 15-21NMDNMD | 15,000 | 1/2" MALE NPT x 1/2" MALE NPT | NMD | NMD | 2 1/8" | 1" |
| 10-21NMFNMF | 10,000 | 3/4" MALE NPT x 3/4" MALE NPT | NMF | NMF | 2 3/8" | 1 1/8" |
| 10-21NMHNMH | 10,000 | 1" MALE NPT x 1" MALE NPT | NMH | NMH | 2 5/8" | 1 3/8" |
| 15-21NMBNMC | 15,000 | 1/4" MALE NPT x 3/8" MALE NPT | NMB | NMC | 2" | 3/4" |
| 15-21NMBNMD | 15,000 | 1/4" MALE NPT x 1/2" MALE NPT | NMB | NMD | 2" | 7/8" |
| 15-21NMCNMD | 15,000 | 3/8" MALE NPT x 1/2" MALE NPT | NMC | NMD | 2" | 1" |

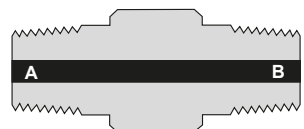



High Pressure Equipment

Adapters: Female to Male NPT

| Catalog No. | Pressure Rating psi | Connections | A | B | Length | Hex Size |
|-------------|---------------------|---------------------------------|-----|-----|--------|----------|
| 15-21NFANMA | 15,000 | 1/8" FEMALE NPT x 1/8" MALE NPT | NFA | NMA | 1 1/2" | 3/4" |
| 15-21NFANMB | 15,000 | 1/8" FEMALE NPT x 1/4" MALE NPT | NFA | NMB | 1 3/4" | 3/4" |
| 15-21NFANMC | 15,000 | 1/8" FEMALE NPT x 3/8" MALE NPT | NFA | NMC | 1 5/8" | 3/4" |
| 15-21NFANMD | 15,000 | 1/8" FEMALE NPT x 1/2" MALE NPT | NFA | NMD | 1 3/4" | 7/8" |
| 15-21NFBNMA | 15,000 | 1/4" FEMALE NPT x 1/8" MALE NPT | NFB | NMA | 1 5/8" | 3/4" |
| 15-21NFBNMB | 15,000 | 1/4" FEMALE NPT x 1/4" MALE NPT | NFB | NMB | 1 5/8" | 1" |
| 15-21NFBNMC | 15,000 | 1/4" FEMALE NPT x 3/8" MALE NPT | NFB | NMC | 1 5/8" | 1" |
| 15-21NFBNMD | 15,000 | 1/4" FEMALE NPT x 1/2" MALE NPT | NFB | NMD | 1 3/4" | 1" |
| 15-21NFCNMB | 15,000 | 3/8" FEMALE NPT x 1/4" MALE NPT | NFC | NMB | 1 7/8" | 1" |
| 15-21NFCNMD | 15,000 | 3/8" FEMALE NPT x 1/2" MALE NPT | NFC | NMD | 1 3/4" | 1" |
| 15-21NFDNMA | 15,000 | 1/2" FEMALE NPT x 1/8" MALE NPT | NFD | NMA | 2" | 1 3/8" |
| 15-21NFDNMB | 15,000 | 1/2" FEMALE NPT x 1/4" MALE NPT | NFD | NMB | 2" | 1 3/8" |
| 15-21NFDNMC | 15,000 | 1/2" FEMALE NPT x 3/8" MALE NPT | NFD | NMC | 1 3/4" | 1 3/8" |
| 15-21NFDNMD | 15,000 | 1/2" FEMALE NPT x 1/2" MALE NPT | NFD | NMD | 2 1/4" | 1 1/8" |
| 10-21NFFNMD | 10,000 | 3/4" FEMALE NPT x 1/2" MALE NPT | NFF | NMD | 2 3/8" | 1 3/8" |
| 10-21NFFNMH | 10,000 | 3/4" FEMALE NPT x 1" MALE NPT | NFF | NMH | 2 3/8" | 1 3/8" |
| 10-21NFHNMD | 10,000 | 1" FEMALE NPT x 1/2" MALE NPT | NFH | NMD | 2 3/4" | 1 7/8" |
| 10-21NFHNMF | 10,000 | 1" FEMALE NPT x 3/4" MALE NPT | NFH | NMF | 2 3/4" | 1 7/8" |

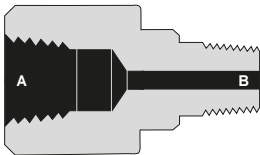

Hose Fittings

We now offer a line of hose adapters designed to easily and safely mate with standard type "M" fittings. Our new hose adapters are rated to the maximum working pressure of the hose or hose-end connection. Our hose fittings are constructed of 316 cold-worked stainless steel with other materials available. HiP maintains an inventory of these fittings for quick ship requirements.



High Pressure to Hose

| Catalog No. | Pressure Rating psi | Connections | A | B | Length | Hex Size |
|--------------|---------------------|-------------------------|-----|-------|--------|----------|
| 40-21HM4HA9 | 40,000 | 1/4" H.P. x 9/16" HOSE | HM4 | 9/16" | 1 3/4" | 3/4" |
| 30-21HM4HA12 | 30,000 | 1/4" H.P. x 3/4" HOSE | HM4 | 3/4" | 1 7/8" | 7/8" |
| 26-21HM4HA16 | 26,000 | 1/4" H.P. x 1" HOSE | HM4 | 1" | 2" | 1 1/8" |
| 40-21HM6HA9 | 40,000 | 3/8" H.P. x 9/16" HOSE | HM6 | 9/16" | 2" | 7/8" |
| 30-21HM6HA12 | 30,000 | 3/8" H.P. x 3/4" HOSE | HM6 | 3/4" | 2 1/8" | 7/8" |
| 26-21HM6HA16 | 26,000 | 3/8" H.P. x 1" HOSE | HM6 | 1" | 2 1/4" | 1 1/8" |
| 40-21HM9HA9 | 40,000 | 9/16" H.P. x 9/16" HOSE | HM9 | 9/16" | 2 1/4" | 1 1/8" |
| 30-21HM9HA12 | 30,000 | 9/16" H.P. x 3/4" HOSE | HM9 | 3/4" | 2 3/8" | 1 1/8" |
| 26-21HM9HA16 | 26,000 | 9/16" H.P. x 1" HOSE | HM9 | 1" | 2 3/8" | 1 1/8" |

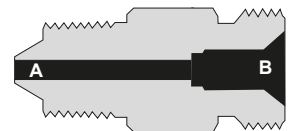

Medium Pressure to Hose

| Catalog No. | Pressure Rating psi | Connections | A | B | Length | Hex Size |
|---------------|---------------------|--------------------------|------|---------|--------|----------|
| 20-21LM4HA9 | 20,000 | 1/4" M.P. x 9/16" HOSE | LM4 | 9/16" | 1 7/8" | 3/4" |
| 20-21LM4HA12 | 20,000 | 1/4" M.P. x 3/4" HOSE | LM4 | 3/4" | 2" | 1" |
| 20-21LM4HA16 | 20,000 | 1/4" M.P. x 1" HOSE | LM4 | 1" | 2 1/8" | 1 1/8" |
| 20-21LM6HA9 | 20,000 | 3/8" M.P. x 9/16" HOSE | LM6 | 9/16" | 1 7/8" | 3/4" |
| 20-21LM6HA12 | 20,000 | 3/8" M.P. x 3/4" HOSE | LM6 | 3/4" | 2" | 1" |
| 20-21LM6HA16 | 20,000 | 3/8" M.P. x 1" HOSE | LM6 | 1" | 2 1/8" | 1 1/8" |
| 20-21LM9HA9 | 20,000 | 9/16" M.P. x 9/16" HOSE | LM9 | 9/16" | 2 1/8" | 1" |
| 20-21LM9HA12 | 20,000 | 9/16" M.P. x 3/4" HOSE | LM9 | 3/4" | 2 1/4" | 1" |
| 20-21LM9HA16 | 20,000 | 9/16" M.P. x 1" HOSE | LM9 | 1" | 2 1/4" | 1 1/8" |
| 20-21LM12HA9 | 20,000 | 3/4" M.P. x 9/16" HOSE | LM12 | 9/16" | 2 1/4" | 1 1/8" |
| 20-21LM12HA12 | 20,000 | 3/4" M.P. x 3/4" HOSE | LM12 | 3/4" | 2 3/8" | 1 1/8" |
| 20-21LM12HA16 | 20,000 | 3/4" M.P. x 1" HOSE | LM12 | 1" | 2 3/8" | 1 1/8" |
| 20-21LM12HA21 | 20,000 | 3/4" M.P. x 1 5/16" HOSE | LM12 | 1 5/16" | 2 3/4" | 1 1/2" |
| 20-21LM16HA9 | 20,000 | 1" M.P. x 9/16" HOSE | LM16 | 9/16" | 3 5/8" | 1 1/8" |
| 20-21LM16HA12 | 20,000 | 1" M.P. x 3/4" HOSE | LM16 | 3/4" | 3 3/4" | 1 1/8" |
| 20-21LM16HA16 | 20,000 | 1" M.P. x 1" HOSE | LM16 | 1" | 3 3/4" | 1 1/8" |
| 20-21LM16HA21 | 20,000 | 1" M.P. x 1 5/16" HOSE | LM16 | 1 5/16" | 4" | 1 1/2" |

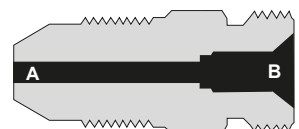



High Pressure Equipment

NPT to Hose

| Catalog No. | Pressure Rating psi | Connections | A | B | Length | Hex Size |
|--------------|---------------------|----------------------------|-----|-------|--------|----------|
| 15-21NMBHA9 | 15,000 | 1/4" NPT MALE x 9/16" HOSE | NMB | 9/16" | 1 5/8" | 5/8" |
| 15-21NMBHA12 | 15,000 | 1/4" NPT MALE x 3/4" HOSE | NMB | 3/4" | 1 7/8" | 7/8" |
| 15-21NMBHA16 | 15,000 | 1/4" NPT MALE x 1" HOSE | NMB | 1" | 1 7/8" | 1" |
| 15-21NMCHA9 | 15,000 | 3/8" NPT MALE x 9/16" HOSE | NMC | 9/16" | 1 5/8" | 3/4" |
| 15-21NMCHA12 | 15,000 | 3/8" NPT MALE x 3/4" HOSE | NMC | 3/4" | 1 7/8" | 7/8" |
| 15-21NMCHA16 | 15,000 | 3/8" NPT MALE x 1" HOSE | NMC | 1" | 1 7/8" | 1" |
| 15-21NMDHA9 | 15,000 | 1/2" NPT MALE x 9/16" HOSE | NMD | 9/16" | 1 7/8" | 7/8" |
| 15-21NMDHA12 | 15,000 | 1/2" NPT MALE x 3/4" HOSE | NMD | 3/4" | 2" | 7/8" |
| 15-21NMDHA16 | 15,000 | 1/2" NPT MALE x 1" HOSE | NMD | 1" | 2" | 1" |
| 10-21NMFHA12 | 10,000 | 3/4" NPT MALE x 3/4" HOSE | NMF | 3/4" | 2" | 1 1/8" |
| 10-21NMFHA16 | 10,000 | 3/4" NPT MALE x 1" HOSE | NMF | 1" | 2" | 1 1/8" |
| 10-21NMHHA16 | 10,000 | 1" NPT MALE x 1" HOSE | NMH | 1" | 2 1/4" | 1 3/8" |



Hose to Hose

| Catalog No. | Pressure Rating psi | Connections | A | B | Length | Hex Size |
|---------------|---------------------|-------------------------|-------|-------|--------|----------|
| 26-21HA9HA9 | 26,000 | 9/16" HOSE x 9/16" HOSE | 9/16" | 9/16" | 1 1/2" | 3/4" |
| 26-21HA9HA12 | 26,000 | 9/16" HOSE x 3/4" HOSE | 9/16" | 3/4" | 1 5/8" | 7/8" |
| 26-21HA9HA16 | 26,000 | 9/16" HOSE x 1" HOSE | 9/16" | 1" | 1 3/4" | 1 1/8" |
| 26-21HA12HA12 | 26,000 | 3/4" HOSE x 3/4" HOSE | 3/4" | 3/4" | 1 3/4" | 7/8" |
| 26-21HA12HA16 | 26,000 | 3/4" HOSE x 1" HOSE | 3/4" | 1" | 1 7/8" | 1 1/8" |
| 26-21HA16HA16 | 26,000 | 1" HOSE x 1" HOSE | 1" | 1" | 1 7/8" | 1 1/8" |

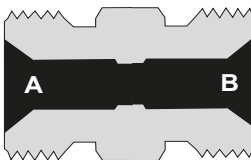



Straight Couplings Reducer Couplings

A complete range of couplings is offered for flexibility in going from tube to tube and from tube to pipe.

All standard coupling bodies are made from high tensile 316 stainless steel. Standard tubing glands and collars (sleeves) are provided with adapters unless otherwise specified.

Taper Seal Straight Couplings

| Catalog No. | Pressure Rating psi | Connections | A | B | Length | Hex Size |
|-------------|---------------------|-------------------|-----|-----|--------|----------|
| 15-21AF1 | 15,000 | 1/16" O.D. TUBING | AF1 | AF1 | 1" | 3/8" |
| 15-21AF2 | 15,000 | 1/8" O.D. TUBING | AF2 | AF2 | 1 1/8" | 3/4" |
| 10-21AF4 | 10,000 | 1/4" O.D. TUBING | AF4 | AF4 | 1 3/8" | 1" |
| 10-21AF6 | 10,000 | 3/8" O.D. TUBING | AF6 | AF6 | 1 3/4" | 1" |

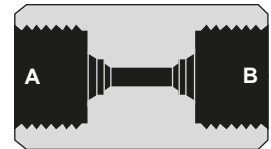

Female Taper Seal to Female NPT

| Catalog No. | Pressure Rating psi | Connections | A | B | Length | Hex Size |
|-------------|---------------------|-----------------------------|-----|-----|--------|----------|
| 15-21AF1NFA | 15,000 | 1/16" O.D. TUBE TO 1/8" NPT | AF1 | NFA | 1 1/8" | 5/8" |
| 15-21AF1NFB | 15,000 | 1/16" O.D. TUBE TO 1/4" NPT | AF1 | NFB | 1 1/8" | 3/4" |
| 15-21AF1NFC | 15,000 | 1/16" O.D. TUBE TO 3/8" NPT | AF1 | NFC | 1 3/8" | 1" |
| 15-21AF1NFD | 15,000 | 1/16" O.D. TUBE TO 1/2" NPT | AF1 | NFD | 1 3/4" | 1 1/8" |
| 15-21AF2NFA | 15,000 | 1/8" O.D. TUBE TO 1/8" NPT | AF2 | NFA | 1 1/4" | 5/8" |
| 15-21AF2NFB | 15,000 | 1/8" O.D. TUBE TO 1/4" NPT | AF2 | NFB | 1 1/4" | 3/4" |
| 15-21AF2NFC | 15,000 | 1/8" O.D. TUBE TO 3/8" NPT | AF2 | NFC | 1 1/2" | 1" |
| 15-21AF2NFD | 15,000 | 1/8" O.D. TUBE TO 1/2" NPT | AF2 | NFD | 1 3/4" | 1 1/8" |
| 10-21AF4NFA | 10,000 | 1/4" O.D. TUBE TO 1/8" NPT | AF4 | NFA | 1 5/8" | 1" |
| 10-21AF4NFB | 10,000 | 1/4" O.D. TUBE TO 1/4" NPT | AF4 | NFB | 1 3/4" | 1" |
| 10-21AF4NFC | 10,000 | 1/4" O.D. TUBE TO 3/8" NPT | AF4 | NFC | 1 7/8" | 1" |
| 10-21AF4NFD | 10,000 | 1/4" O.D. TUBE TO 1/2" NPT | AF4 | NFD | 1 7/8" | 1 1/8" |
| 10-21AF4NFF | 10,000 | 1/4" O.D. TUBE TO 3/4" NPT | AF4 | NFF | 2 3/8" | 1 3/8" |
| 10-21AF4NFH | 10,000 | 1/4" O.D. TUBE TO 1" NPT | AF4 | NFH | 2 5/8" | 1 7/8" |
| 10-21AF6NFA | 10,000 | 3/8" O.D. TUBE TO 1/8" NPT | AF6 | NFA | 1 5/8" | 1" |
| 10-21AF6NFB | 10,000 | 3/8" O.D. TUBE TO 1/4" NPT | AF6 | NFB | 1 3/4" | 1" |
| 10-21AF6NFC | 10,000 | 3/8" O.D. TUBE TO 3/8" NPT | AF6 | NFC | 1 7/8" | 1" |
| 10-21AF6NFD | 10,000 | 3/8" O.D. TUBE TO 1/2" NPT | AF6 | NFD | 2 1/8" | 1 1/8" |
| 10-21AF6NFF | 10,000 | 3/8" O.D. TUBE TO 3/4" NPT | AF6 | NFF | 2 3/8" | 1 3/8" |
| 10-21AF6NFH | 10,000 | 3/8" O.D. TUBE TO 1" NPT | AF6 | NFH | 2 5/8" | 1 7/8" |

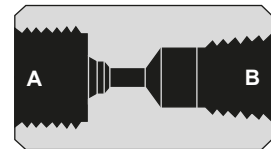



High Pressure Equipment

Female Taper Seal to Female High Pressure

| Catalog No. | Pressure Rating psi | Connections | A | B | Length | Hex Size |
|-------------|---------------------|-------------------------------|-----|-----|--------|----------|
| 15-21AF1HF2 | 15,000 | 1/16" O.D. TUBE TO 1/8" H.P. | AF1 | HF2 | 1 1/8" | 5/8" |
| 15-21AF1HF4 | 15,000 | 1/16" O.D. TUBE TO 1/4" H.P. | AF1 | HF4 | 1 1/4" | 3/4" |
| 15-21AF1HF6 | 15,000 | 1/16" O.D. TUBE TO 3/8" H.P. | AF1 | HF6 | 1 3/8" | 1" |
| 15-21AF1HF9 | 15,000 | 1/16" O.D. TUBE TO 9/16" H.P. | AF1 | HF9 | 2 3/8" | 1 3/8" |
| 15-21AF2HF2 | 15,000 | 1/8" O.D. TUBE TO 1/8" H.P. | AF2 | HF2 | 1 1/8" | 3/4" |
| 15-21AF2HF4 | 15,000 | 1/8" O.D. TUBE TO 1/4" H.P. | AF2 | HF4 | 1 1/4" | 3/4" |
| 15-21AF2HF6 | 15,000 | 1/8" O.D. TUBE TO 3/8" H.P. | AF2 | HF6 | 1 7/8" | 1" |
| 15-21AF2HF9 | 15,000 | 1/8" O.D. TUBE TO 9/16" H.P. | AF2 | HF9 | 2 3/8" | 1 3/8" |
| 10-21AF4HF2 | 10,000 | 1/4" O.D. TUBE TO 1/8" H.P. | AF4 | HF2 | 1 3/8" | 1" |
| 10-21AF4HF4 | 10,000 | 1/4" O.D. TUBE TO 1/4" H.P. | AF4 | HF4 | 1 1/2" | 1" |
| 10-21AF4HF6 | 10,000 | 1/4" O.D. TUBE TO 3/8" H.P. | AF4 | HF6 | 1 7/8" | 1" |
| 10-21AF4HF9 | 10,000 | 1/4" O.D. TUBE TO 9/16" H.P. | AF4 | HF9 | 2 3/8" | 1 3/8" |
| 10-21AF6HF2 | 10,000 | 3/8" O.D. TUBE TO 1/8" H.P. | AF6 | HF2 | 1 1/2" | 1" |
| 10-21AF6HF4 | 10,000 | 3/8" O.D. TUBE TO 1/4" H.P. | AF6 | HF4 | 1 3/4" | 1" |
| 10-21AF6HF6 | 10,000 | 3/8" O.D. TUBE TO 3/8" H.P. | AF6 | HF6 | 1 7/8" | 1" |
| 10-21AF6HF9 | 10,000 | 3/8" O.D. TUBE TO 9/16" H.P. | AF6 | HF9 | 2 3/8" | 1 3/8" |

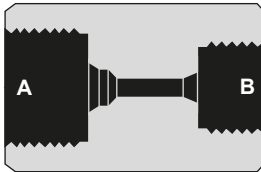

Taper Seal Reducer Couplings

| Catalog No. | Pressure Rating psi | Connections | A | B | Length | Hex Size |
|-------------|---------------------|------------------------------|-----|-----|--------|----------|
| 15-21AF1AF2 | 15,000 | 1/16" O.D. TO 1/8" O.D. TUBE | AF1 | AF2 | 1 1/8" | 5/8" |
| 10-21AF1AF4 | 10,000 | 1/16" O.D. TO 1/4" O.D. TUBE | AF1 | AF4 | 1 3/8" | 1" |
| 10-21AF1AF6 | 10,000 | 1/16" O.D. TO 3/8" O.D. TUBE | AF1 | AF6 | 1 3/8" | 1" |
| 10-21AF2AF4 | 10,000 | 1/8" O.D. TO 1/4" O.D. TUBE | AF2 | AF4 | 1 1/2" | 1" |
| 10-21AF2AF6 | 10,000 | 1/8" O.D. TO 3/8" O.D. TUBE | AF2 | AF6 | 1 1/2" | 1" |
| 10-21AF4AF6 | 10,000 | 1/4" O.D. TO 3/8" O.D. TUBE | AF4 | AF6 | 1 3/4" | 1" |

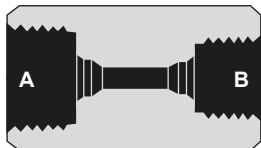

Female Medium Pressure to Female Medium Pressure

| Catalog No. | Pressure Rating psi | Connections | A | B | Length | Hex Size |
|---------------|---------------------|-------------------------|------|------|--------|----------|
| 20-21LF4LF6 | 20,000 | 1/4" M.P. to 3/8" M.P. | LF4 | LF6 | 1 3/4" | 3/4" |
| 20-21LF4LF9 | 20,000 | 1/4" M.P. to 9/16" M.P. | LF4 | LF9 | 2 1/8" | 1" |
| 20-21LF6LF9 | 20,000 | 3/8" M.P. to 9/16" M.P. | LF6 | LF9 | 2 1/8" | 1" |
| 20-21LF4LF12 | 20,000 | 1/4" M.P. to 3/4" M.P. | LF4 | LF12 | 2 1/2" | 1 3/8" |
| 20-21LF6LF12 | 20,000 | 3/8" M.P. to 3/4" M.P. | LF6 | LF12 | 2 1/2" | 1 3/8" |
| 20-21LF9LF12 | 20,000 | 9/16" M.P. to 3/4" M.P. | LF9 | LF12 | 2 1/2" | 1 3/8" |
| 20-21LF4LF16 | 20,000 | 1/4" M.P. to 1" M.P. | LF4 | LF16 | 3 1/2" | 1 3/4" |
| 20-21LF6LF16 | 20,000 | 3/8" M.P. to 1" M.P. | LF6 | LF16 | 3 1/2" | 1 3/4" |
| 20-21LF9LF16 | 20,000 | 9/16" M.P. to 1" M.P. | LF9 | LF16 | 3 1/2" | 1 3/4" |
| 20-21LF12LF16 | 20,000 | 3/4" M.P. to 1" M.P. | LF12 | LF16 | 3 1/2" | 1 3/4" |

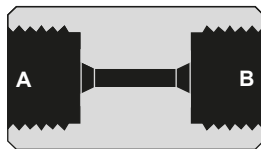

Female Medium Pressure to Female Pipe

| Catalog No. | Pressure Rating psi | Connections | A | B | Length | Hex Size |
|--------------|---------------------|-------------------------------|------|------|--------|----------|
| 20-21LF4NFA | 15,000 | 1/4" M.P. to 1/8" NPT FEMALE | LF4 | NFA | 1 5/8" | 3/4" |
| 20-21LF4NFB | 15,000 | 1/4" M.P. to 1/4" NPT FEMALE | LF4 | NFB | 1 5/8" | 3/4" |
| 20-21LF4NFC | 15,000 | 1/4" M.P. to 3/8" NPT FEMALE | LF4 | NFC | 2" | 1" |
| 20-21LF4NFD | 15,000 | 1/4" M.P. to 1/2" NPT FEMALE | LF4 | NFD | 2" | 1 1/8" |
| 10-21LF4NFF | 10,000 | 1/4" M.P. to 3/4" NPT FEMALE | LF4 | NFF | 2 3/8" | 1 3/8" |
| 10-21LF4NFH | 10,000 | 1/4" M.P. to 1" NPT FEMALE | LF4 | NFH | 2 5/8" | 1 7/8" |
| 20-21LF6NFA | 15,000 | 3/8" M.P. to 1/8" NPT FEMALE | LF6 | NFA | 1 3/4" | 3/4" |
| 20-21LF6NFB | 15,000 | 3/8" M.P. to 1/4" NPT FEMALE | LF6 | NFB | 1 3/4" | 3/4" |
| 20-21LF6NFC | 15,000 | 3/8" M.P. to 3/8" NPT FEMALE | LF6 | NFC | 2 1/8" | 1" |
| 20-21LF6NFD | 15,000 | 3/8" M.P. to 1/2" NPT FEMALE | LF6 | NFD | 2 1/8" | 1 1/8" |
| 10-21LF6NFF | 10,000 | 3/8" M.P. to 3/4" NPT FEMALE | LF6 | NFIF | 2 3/8" | 1 3/8" |
| 10-21LF6NFH | 10,000 | 3/8" M.P. to 1" NPT FEMALE | LF6 | NFH | 2 3/4" | 1 7/8" |
| 20-21LF9NFA | 15,000 | 9/16" M.P. to 1/8" NPT FEMALE | LF9 | NFA | 2 1/8" | 1" |
| 20-21LF9NFB | 15,000 | 9/16" M.P. to 1/4" NPT FEMALE | LF9 | NFB | 2 1/8" | 1" |
| 20-21LF9NFC | 15,000 | 9/16" M.P. to 3/8" NPT FEMALE | LF9 | NFC | 2 1/8" | 1" |
| 20-21LF9NFD | 15,000 | 9/16" M.P. to 1/2" NPT FEMALE | LF9 | NFD | 2 1/4" | 1 1/8" |
| 10-21LF9NFF | 10,000 | 9/16" M.P. to 3/4" NPT FEMALE | LF9 | NFF | 2 1/2" | 1 3/8" |
| 10-21LF9NFH | 10,000 | 9/16" M.P. to 1" NPT FEMALE | LF9 | NFH | 2 7/8" | 1 7/8" |
| 20-21LF12NFA | 15,000 | 3/4" M.P. to 1/8" NPT FEMALE | LF12 | NFA | 2 1/2" | 1 3/8" |
| 20-21LF12NFB | 15,000 | 3/4" M.P. to 1/4" NPT FEMALE | LF12 | NFB | 2 1/2" | 1 3/8" |
| 20-21LF12NFC | 15,000 | 3/4" M.P. to 3/8" NPT FEMALE | LF12 | NFC | 2 1/2" | 1 3/8" |
| 20-21LF12NFD | 15,000 | 3/4" M.P. to 1/2" NPT FEMALE | LF12 | NFD | 2 1/2" | 1 3/8" |
| 10-21LF12NFF | 10,000 | 3/4" M.P. to 3/4" NPT FEMALE | LF12 | NFF | 2 3/4" | 1 1/2" |
| 10-21LF12NFH | 10,000 | 3/4" M.P. to 1" NPT FEMALE | LF12 | NFH | 3" | 1 7/8" |
| 20-21LF16NFA | 15,000 | 1" M.P. to 1/8" NPT FEMALE | LF16 | NFA | 3" | 1 3/4" |
| 20-21LF16NFB | 15,000 | 1" M.P. to 1/4" NPT FEMALE | LF16 | NFB | 3" | 1 3/4" |
| 20-21LF16NFC | 15,000 | 1" M.P. to 3/8" NPT FEMALE | LF16 | NFC | 3" | 1 3/4" |
| 20-21LF16NFD | 15,000 | 1" M.P. to 1/2" NPT FEMALE | LF16 | NFD | 3" | 1 3/4" |
| 10-21LF16NFF | 10,000 | 1" M.P. to 3/4" NPT FEMALE | LF16 | NFF | 3 1/4" | 1 3/4" |
| 10-21LF16NFH | 10,000 | 1" M.P. to 1" NPT FEMALE | LF16 | NFH | 3 1/4" | 1 3/4" |

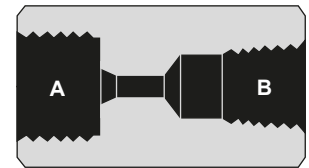

Medium Pressure Straight Couplings

| Catalog No. | Pressure Rating psi | Connections | A | B | Length | Hex Size |
|-------------|---------------------|-------------------|------|------|---------|----------|
| 20-21LF4 | 20,000 | 1/4" O.D. TUBING | LF4 | LF4 | 1 9/16" | 5/8" |
| 20-21LF6 | 20,000 | 3/8" O.D. TUBING | LF6 | LF6 | 1 3/4" | 3/4" |
| 20-21LF9 | 20,000 | 9/16" O.D. TUBING | LF9 | LF9 | 2 1/8" | 1" |
| 20-21LF12 | 20,000 | 3/4" O.D. TUBING | LF12 | LF12 | 2 1/2" | 1 3/8" |
| 20-21LF16 | 20,000 | 1" O.D. TUBING | LF16 | LF16 | 3 1/2" | 1 3/4" |

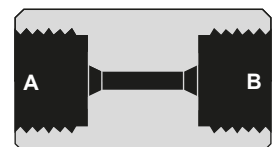



High Pressure Equipment

Female Medium Pressure to Female High Pressure

| Catalog No. | Pressure Rating psi | Connections | A | B | Length | Hex Size |
|----------------|---------------------|--------------------------|------|-----|--------|----------|
| 20-21LF4HF4 | 20,000 | 1/4" M.P. to 1/4" H.P. | LF4 | HF4 | 1 5/8" | 3/4" |
| 20-21LF4HF6 | 20,000 | 1/4" M.P. to 3/8" H.P. | LF4 | HF6 | 1 7/8" | 1" |
| 20-21LF4HF9 | 20,000 | 1/4" M.P. to 9/16" H.P. | LF4 | HF9 | 2 3/8" | 1 3/8" |
| 20-21LF6HF4 | 20,000 | 3/8" M.P. to 1/4" H.P. | LF6 | HF4 | 1 3/4" | 3/4" |
| 20-21LF6HF6 | 20,000 | 3/8" M.P. to 3/8" H.P. | LF6 | HF6 | 1 7/8" | 1" |
| 20-21LF6HF9 | 20,000 | 3/8" M.P. to 9/16" H.P. | LF6 | HF9 | 2 3/8" | 1 3/8" |
| 20-21LF9HF4 | 20,000 | 9/16" M.P. to 1/4" H.P. | LF9 | HF4 | 2 1/8" | 1" |
| 20-21LF9HF6 | 20,000 | 9/16" M.P. to 3/8" H.P. | LF9 | HF6 | 2 1/8" | 1" |
| 20-21LF9HF9 | 20,000 | 9/16" M.P. to 9/16" H.P. | LF9 | HF9 | 2 3/8" | 1 3/8" |
| 20-21LF12HF4 | 20,000 | 3/4" M.P. to 1/4" H.P. | LF12 | HF4 | 2 1/2" | 1 3/8" |
| 20-21LF12HF6 | 20,000 | 3/4" M.P. to 3/8" H.P. | LF12 | HF6 | 2 1/2" | 1 3/8" |
| 20-21LF12HF9 | 20,000 | 3/4" M.P. to 9/16" H.P. | LF12 | HF9 | 2 1/2" | 1 3/8" |
| * 20-21HF16HF4 | 20,000 | 1" M.P. to 1/4" H.P. | HF16 | HF4 | 3 1/2" | 1 3/4" |
| * 20-21HF16HF6 | 20,000 | 1" M.P. to 3/8" H.P. | HF16 | HF6 | 3 1/2" | 1 3/4" |
| * 20-21HF16HF9 | 20,000 | 1" M.P. to 9/16" H.P. | HF16 | HF9 | 3 1/2" | 1 3/4" |

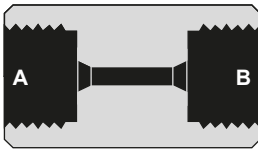

* Can be rated to 30,000 psi if used with 1" O.D. x 7/16" I.D. tubing.

High Pressure Straight Couplings

| Catalog No. | Pressure Rating psi | Connections | A | B | Length | Hex Size |
|-------------|---------------------|-------------------|------|------|--------|----------|
| 60-21HF2 | 60,000 | 1/8" O.D. TUBING | HF2 | HF2 | 1 1/8" | 3/4" |
| 60-21HF4 | 60,000 | 1/4" O.D. TUBING | HF4 | HF4 | 1 3/4" | 1" |
| 60-21HF6 | 60,000 | 3/8" O.D. TUBING | HF6 | HF6 | 2" | 1" |
| 60-21HF9 | 60,000 | 9/16" O.D. TUBING | HF9 | HF9 | 2 3/8" | 1 3/8" |
| 30-21HF16 | 30,000 | 1" O.D. TUBING | HF16 | HF16 | 3 1/2" | 1 3/4" |

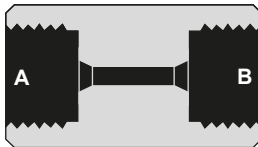

High Pressure Reducer Couplings

| Catalog No. | Pressure Rating psi | Connections | A | B | Length | Hex Size |
|-------------|---------------------|-------------------------------|-----|-----|--------|----------|
| 60-21HF2HF4 | 60,000 | 1/8" O.D. TO 1/4" O.D. TUBE | HF2 | HF4 | 1 1/4" | 3/4" |
| 60-21HF2HF6 | 60,000 | 1/8" O.D. TO 3/8" O.D. TUBE | HF2 | HF6 | 1 5/8" | 1" |
| 60-21HF2HF9 | 60,000 | 1/16" O.D. TO 9/16" O.D. TUBE | HF2 | HF9 | 1 3/4" | 1 3/8" |
| 60-21HF4HF6 | 60,000 | 1/4" O.D. TO 3/8" O.D. TUBE | HF4 | HF6 | 1 5/8" | 1" |
| 60-21HF4HF9 | 60,000 | 1/4" O.D. TO 9/16" O.D. TUBE | HF4 | HF9 | 1 3/4" | 1 3/8" |
| 60-21HF6HF9 | 60,000 | 3/8" O.D. TO 9/16" O.D. TUBE | HF6 | HF9 | 2" | 1 3/8" |

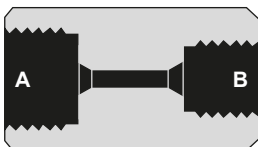

Female High Pressure to Female NPT Pipe

| Catalog No. | Pressure Rating psi | Connections | A | B | Length | Hex Size |
|-------------|---------------------|-----------------------------|-----|-----|--------|----------|
| 30-21HF2NFA | 15,000 | 1/8" O.D. TUBE TO 1/8" NPT | HF2 | NFA | 1 1/2" | 3/4" |
| 30-21HF2NFB | 15,000 | 1/8" O.D. TUBE TO 1/4" NPT | HF2 | NFB | 1 1/2" | 3/4" |
| 30-21HF2NFC | 15,000 | 1/8" O.D. TUBE TO 3/8" NPT | HF2 | NFC | 1 1/2" | 1" |
| 30-21HF2NFD | 15,000 | 1/8" O.D. TUBE TO 1/2" NPT | HF2 | NFD | 1 3/4" | 1 1/8" |
| 10-21HF2NFF | 10,000 | 1/8" O.D. TUBE TO 3/4" NPT | HF2 | NFF | 2" | 1 3/8" |
| 10-21HF2NFH | 10,000 | 1/8" O.D. TUBE TO 1" NPT | HF2 | NFH | 2 1/2" | 1 3/4" |
| 30-21HF4NFA | 15,000 | 1/4" O.D. TUBE TO 1/8" NPT | HF4 | NFA | 1 1/2" | 1" |
| 30-21HF4NFB | 15,000 | 1/4" O.D. TUBE TO 1/4" NPT | HF4 | NFB | 1 1/2" | 1" |
| 30-21HF4NFC | 15,000 | 1/4" O.D. TUBE TO 3/8" NPT | HF4 | NFC | 1 7/8" | 1" |
| 30-21HF4NFD | 15,000 | 1/4" O.D. TUBE TO 1/2" NPT | HF4 | NFD | 1 7/8" | 1 1/8" |
| 10-21HF4NFF | 10,000 | 1/4" O.D. TUBE TO 3/4" NPT | HF4 | NFF | 2" | 1 3/8" |
| 10-21HF4NFH | 10,000 | 1/4" O.D. TUBE TO 1" NPT | HF4 | NFH | 2 1/2" | 1 3/4" |
| 30-21HF6NFA | 15,000 | 3/8" O.D. TUBE TO 1/8" NPT | HF6 | NFA | 1 7/8" | 1" |
| 30-21HF6NFB | 15,000 | 3/8" O.D. TUBE TO 1/4" NPT | HF6 | NFB | 1 7/8" | 1" |
| 30-21HF6NFC | 15,000 | 3/8" O.D. TUBE TO 3/8" NPT | HF6 | NFC | 1 7/8" | 1" |
| 30-21HF6NFD | 15,000 | 3/8" O.D. TUBE TO 1/2" NPT | HF6 | NFD | 1 7/8" | 1 1/8" |
| 10-21HF6NFF | 10,000 | 3/8" O.D. TUBE TO 3/4" NPT | HF6 | NFF | 2 1/8" | 1 3/8" |
| 10-21HF6NFH | 10,000 | 3/8" O.D. TUBE TO 1" NPT | HF6 | NFH | 2 5/8" | 1 7/8" |
| 30-21HF9NFA | 15,000 | 9/16" O.D. TUBE TO 1/8" NPT | HF9 | NFA | 2 3/8" | 1 3/8" |
| 30-21HF9NFB | 15,000 | 9/16" O.D. TUBE TO 1/4" NPT | HF9 | NFB | 2 3/8" | 1 3/8" |
| 30-21HF9NFC | 15,000 | 9/16" O.D. TUBE TO 3/8" NPT | HF9 | NFC | 2 3/8" | 1 3/8" |
| 30-21HF9NFD | 15,000 | 9/16" O.D. TUBE TO 1/2" NPT | HF9 | NFD | 2 3/8" | 1 3/8" |
| 10-21HF9NFF | 10,000 | 9/16" O.D. TUBE TO 3/4" NPT | HF9 | NFF | 2 3/8" | 1 3/8" |
| 10-21HF9NFH | 10,000 | 9/16" O.D. TUBE TO 1" NPT | HF9 | NFH | 2 5/8" | 2" |

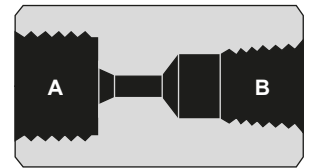

High Pressure Equipment offers an extensive selection of couplings and adapters to meet virtually every requirement.



High Pressure Equipment

Thermocouple Adapters

The $\frac{1}{16}$ " O.D. and $\frac{1}{8}$ " O.D. tubing sizes of the Taper Seal connections are ideally suited for use with thermocouples for pressures up to 15,000 psi.

These connectors do not bite into the outer wall of the thermocouple, but rather clamp onto the tubing (or thermocouple) similar to a machine collet. A thread lubricant is recommended on the gland nut when initially making up the connection, but such lubrication can later be removed if desired. Material is high tensile 316 stainless steel. Standard glands and sleeves are provided unless otherwise specified.

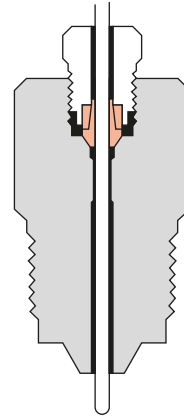

Adapters for $\frac{1}{16}$ " TCs

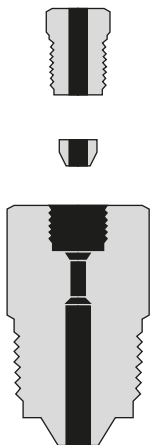

| Catalog No. | Pressure Rating psi | Male End of Adapter | Length | Hex Size |
|---------------|---------------------|--------------------------------|------------------|------------------|
| 15-21AF1AM2-T | 15,000 | $\frac{1}{8}$ " TAPER SEAL | $\frac{7}{8}$ " | $\frac{1}{2}$ " |
| 10-21AF1AM4-T | 10,000 | $\frac{1}{4}$ " TAPER SEAL | $1\frac{1}{4}$ " | $\frac{3}{4}$ " |
| 10-21AF1AM6-T | 10,000 | $\frac{3}{8}$ " TAPER SEAL | $1\frac{1}{4}$ " | $\frac{3}{4}$ " |
| 15-21AF1HM2-T | 15,000 | $\frac{1}{8}$ " HIGH PRESSURE | $\frac{7}{8}$ " | $\frac{1}{2}$ " |
| 15-21AF1HM4-T | 15,000 | $\frac{1}{4}$ " HIGH PRESSURE | $1\frac{1}{4}$ " | $\frac{5}{8}$ " |
| 15-21AF1HM6-T | 15,000 | $\frac{3}{8}$ " HIGH PRESSURE | $1\frac{3}{4}$ " | $\frac{3}{4}$ " |
| 15-21AF1HM9-T | 15,000 | $\frac{9}{16}$ " HIGH PRESSURE | $2\frac{1}{8}$ " | $1\frac{1}{8}$ " |
| 15-21AF1NMA-T | 15,000 | $\frac{1}{8}$ " NPT | 1" | $\frac{1}{2}$ " |
| 15-21AF1NMB-T | 15,000 | $\frac{1}{4}$ " NPT | $1\frac{1}{4}$ " | $\frac{5}{8}$ " |
| 15-21AF1NMC-T | 15,000 | $\frac{3}{8}$ " NPT | $1\frac{3}{8}$ " | $\frac{3}{4}$ " |
| 15-21AF1NMD-T | 15,000 | $\frac{1}{2}$ " NPT | $1\frac{3}{4}$ " | 1" |
| 10-21AF1NMF-T | 10,000 | $\frac{3}{4}$ " NPT | $1\frac{7}{8}$ " | $1\frac{3}{8}$ " |
| 10-21AF1NMH-T | 10,000 | 1" NPT | $1\frac{5}{8}$ " | $1\frac{3}{8}$ " |

Adapters for $\frac{1}{8}$ " TCs

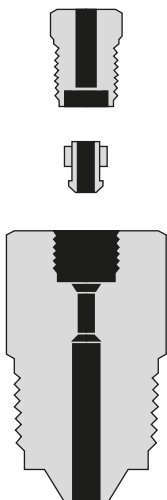

| Catalog No. | Pressure Rating psi | Male End of Adapter | Length | Hex Size |
|---------------|---------------------|--------------------------------|------------------|------------------|
| 10-21AF2AM4-T | 10,000 | $\frac{1}{4}$ " TAPER SEAL | $1\frac{1}{4}$ " | $\frac{3}{4}$ " |
| 10-21AF2AM6-T | 10,000 | $\frac{3}{8}$ " TAPER SEAL | $1\frac{1}{4}$ " | $\frac{3}{4}$ " |
| 15-21AF2HM4-T | 15,000 | $\frac{1}{4}$ " HIGH PRESSURE | $1\frac{1}{4}$ " | $\frac{5}{8}$ " |
| 15-21AF2HM6-T | 15,000 | $\frac{3}{8}$ " HIGH PRESSURE | $1\frac{3}{4}$ " | $\frac{3}{4}$ " |
| 15-21AF2HM9-T | 15,000 | $\frac{9}{16}$ " HIGH PRESSURE | $2\frac{1}{8}$ " | $1\frac{1}{8}$ " |
| 15-21AF2NMA-T | 15,000 | $\frac{1}{8}$ " NPT | $1\frac{1}{4}$ " | $\frac{3}{4}$ " |
| 15-21AF2NMB-T | 15,000 | $\frac{1}{4}$ " NPT | $1\frac{1}{4}$ " | $\frac{5}{8}$ " |
| 15-21AF2NMC-T | 15,000 | $\frac{3}{8}$ " NPT | $1\frac{3}{8}$ " | $\frac{3}{4}$ " |
| 15-21AF2NMD-T | 15,000 | $\frac{1}{2}$ " NPT | $1\frac{3}{4}$ " | 1" |
| 10-21AF2NMF-T | 10,000 | $\frac{3}{4}$ " NPT | $1\frac{7}{8}$ " | $1\frac{3}{8}$ " |
| 10-21AF2NMH-T | 10,000 | 1" NPT | $1\frac{5}{8}$ " | $1\frac{3}{8}$ " |

Pressure Gauges



Standard pressure gauges as shown are available from stock for immediate delivery. Gauge models 4PG5 through 6PG50 are standard with a High Pressure $\frac{1}{4}$ " O.D. tubing connection (HF4), while models 6PG75, 6PG100 and 6PG150 have an Ultra High Pressure $\frac{3}{8}$ " O.D. tubing connection (XF6). These coned and threaded connections are machined directly into the bottom inlet of the gauges. Adapters for other size connections are available from stock.

These gauges have a solid front separating the dial face from the pressure tube in order to provide maximum safety. Bourdon tube and socket are 316 S.S. on all gauges. Both styles include a safety blowout back. 5,000 psi to 30,000 psi gauges have laminated safety glass, while the 50,000 psi to 150,000 psi style have a removable polycarbonate plastic front window. Gauges may be used intermittently to 100 percent of dial reading.

Accuracy on 5,000 psi and 10,000 psi models is $\frac{1}{2}$ % of full scale reading. Accuracy on 20,000 psi through 30,000 psi models is 1% of full scale reading. Accuracy on 50,000 psi through 150,000 psi models is $\frac{1}{2}$ % of full scale reading.

PANEL MOUNTING: 4PG5, 4PG10, 6PG20, 6PG30

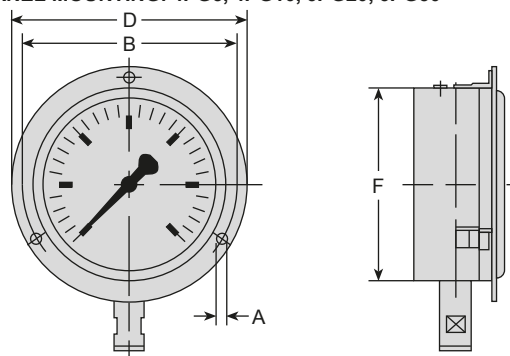

Standard Gauges In Stock

| Gauge Size | | | | Materials | |
|-------------|-----------|-----------|---------------------|-----------|------------------|
| Catalog No. | Range psi | Dial Size | Graduations | Mounting | Case |
| 4PG5 | 0-5,000 | 4" | 500 100 50 | Panel | 316 S.S. |
| 4PG10 | 0-10,000 | 4" | 1,000 500 100 | | |
| 6PG20 | 0-20,000 | 6" | 2,000 1,000 200 | | |
| 6PG30 | 0-30,000 | 6" | 3,000 1,000 200 | | |
| 6PG50 | 0-50,000 | 6" | 5,000 2,500 500 | * Surface | Heavy Duty Alum. |
| 6PG75 | 0-75,000 | 6" | 10,000 2,500 500 | | |
| 6PG100 | 0-100,000 | 6" | 10,000 5,000 1,000 | | |
| 6PG150 | 0-150,000 | 6" | 20,000 10,000 1,000 | | |

* Panel mount kit available. Contact factory.

SURFACE MOUNTING: 6PG50, 6PG75, 6PG100

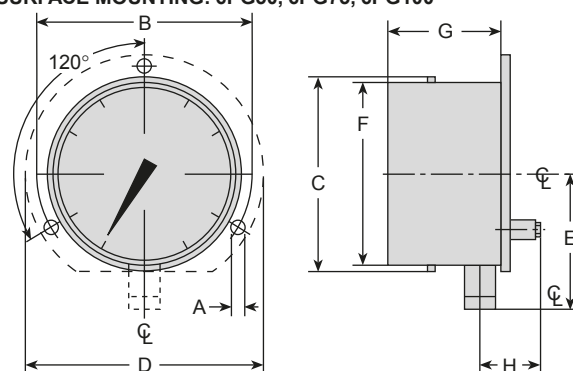

Dimensions

| Dial Size | A | B | C | D | E | F | G | H |
|---------------------------------|------------------|--------------------|------------------|--------------------|------------------|--------------------------------------|------------------|------------------|
| 4" 4PG5, 4PG10 | $\frac{3}{16}$ " | $4\frac{35}{64}$ " | — | $5\frac{3}{16}$ " | — | $3\frac{1}{8}$ " | — | — |
| 6" 6PG20, 6PG30 | $\frac{7}{32}$ " | 7" | — | $7\frac{11}{16}$ " | — | $6\frac{1}{4}$ " – $6\frac{5}{16}$ " | — | — |
| 6" 6PG50, 6PG75, 6PG100, 6PG150 | $\frac{9}{32}$ " | 7" | $6\frac{5}{8}$ " | $7\frac{5}{8}$ " | $4\frac{3}{8}$ " | $6\frac{3}{8}$ " | $3\frac{5}{8}$ " | $1\frac{3}{4}$ " |



High Pressure Equipment

Tooling

To ensure safe and leak-free operation of your pressure system, High Pressure Equipment Company provides complete installation instructions for the make-up of a coned and threaded connection. In addition to outlining the correct procedures, we offer coning and threading tools and female tubing connection tools.



| Index | Page |
|------------------------------------------|------|
| Reseating Tools | 9.2 |
| Coning Tools | 9.3 |
| Threading Tools | 9.3 |
| Coning & Threading Instructions | 9.4 |



High Pressure Equipment

Tooling

The coned and threaded tubing ends for the medium, high and ultra high pressure connections may be supplied by any of the following:

1. Standard length tubing nipples with ends prepared. Maintained in stock—ready for shipment.
2. Special length tubing nipples with ends prepared. Specify length required (up to 22 feet long). Add coning and threading charge to tubing price. (While not in stock, special length nipples can be furnished quickly for prompt delivery).
3. Preparation of tubing ends at your own facility by hand tooling as described in this section.

The coning and threading tools are designed for simple yet accurate preparation of tubing ends for the medium, high and ultra high pressure connections. A liberal amount of cutting fluid should be used, and a supply is furnished with each order for tooling. Interchangeable spare parts allow easy change over from one size tubing to another on both the coning and threading tools. Note that the reseating tool is not required for tubing preparation.

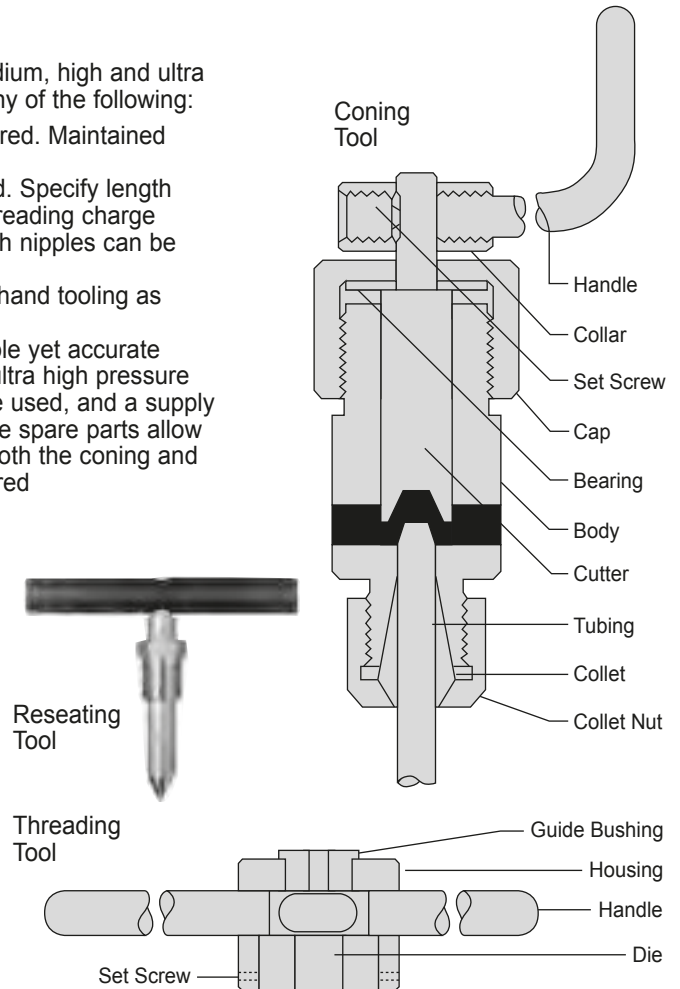
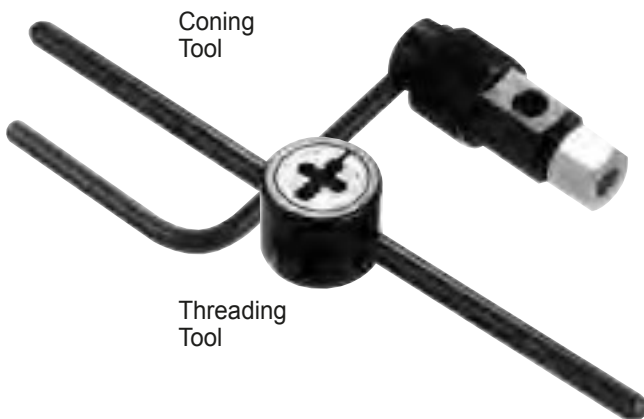

Reseating Tools

The reseating tools are available for repairing old or damaged tubing connection seats in valves or fittings. This tool is not required for tubing preparation.

| Catalog No. | For Tubing Connection |
|-------------|-----------------------|
| RTLF4 | LF4 |
| RTLF6 | LF6 |
| RTLF9 | LF9 |
| RTHF2 | HF2 |
| RTHF4 | HF4 |
| RTHF6 | HF6 |
| RTHF9 | HF9 |
| RTXF4 | XF4 |
| RTXF6 | XF6 |

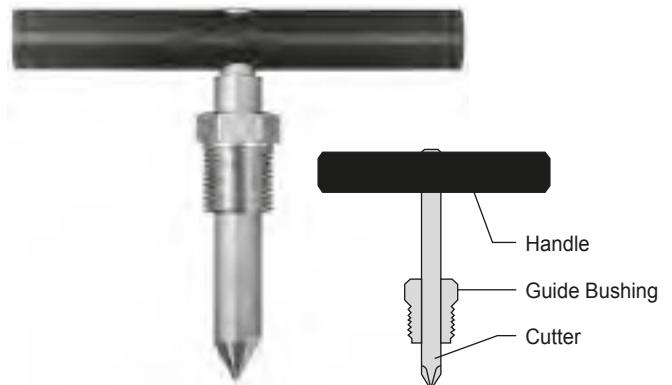

Coning Tools

The coning tool is designed for preparing a “cone” on the ends of Medium, High and Ultra High Pressure tubing. Included angle of the cone is approximately 57 to 59 degrees. The cutter and collet are interchangeable on all of the assemblies (except 2-HF9 and 2-LF9) to permit changing from one size tubing to another.

| Catalog No. | Tubing Size | Spare Cutter | Spare Collet |
|-------------|------------------------------------------------------------------------------------------------|--------------|--------------|
| 2-LF4 | $\frac{1}{4}$ " O.D. x .109" I.D. (20,000 psi) | 2-LF4L | 2-LF4P |
| 2-LF6 | $\frac{3}{8}$ " O.D. x .203 I.D. (20,000 psi) | 2-LF6L | 2-LF6P |
| 2-LF9 | $\frac{9}{16}$ " O.D. x .312 I.D. (20,000 psi) | 2-LF9L* | 2-LF9P |
| 2-HF2 | $\frac{1}{8}$ " O.D. x .020 I.D. (60,000 psi) $\frac{1}{8}$ " O.D. x .040 I.D. (30,000 psi) | 2-HF2L | 2-HF2P |
| 2-HF4 | $\frac{1}{4}$ " O.D. x .083 I.D. (60,000 psi) | 2-HF4L | 2-HF4P |
| 2-HF6 | $\frac{3}{8}$ " O.D. x $\frac{1}{8}$ " I.D. (60,000 psi) | 2-HF6L | 2-HF6P |
| 2-HF9 | $\frac{9}{16}$ " O.D. x $\frac{3}{16}$ " I.D. x (60,000 psi) | 2-HF9L* | 2-HF9P |
| 2-XF4 | $\frac{1}{4}$ " O.D. x $\frac{1}{16}$ " I.D. (100,000 psi) | 2-XF4L | 2-XF4P |
| 2-XF6 | $\frac{3}{8}$ " O.D. x $\frac{1}{16}$ " I.D. (150,000 psi) | 2-XF6L | 2-XF6P |

* Not interchangeable



Threading Tools

The threading tool is designed for preparing a left-hand thread onto Medium, High and Ultra High Pressure tubing ends. The threaded die and guide bushings are interchangeable on all of the assemblies (except 2-MHF2) to permit changing from one size tubing to another.

| Catalog No. | Tubing Size | Spare Threading Die | Spare Guide Bushing |
|-------------|-----------------------|-----------------------|---------------------|
| 2-MLF4 | $\frac{1}{4}$ " O.D. | $\frac{1}{4}$ "-28LH | 2-MLF4P |
| 2-MLF6 | $\frac{3}{8}$ " O.D. | $\frac{3}{8}$ "-24LH | 2-MLF6P |
| 2-MLF9 | $\frac{9}{16}$ " O.D. | $\frac{9}{16}$ "-18LH | 2-MLF9P |
| 2-MHF4 | $\frac{1}{4}$ " O.D. | $\frac{1}{4}$ "-28LH | 2-MHF4P |
| 2-MHF6 | $\frac{3}{8}$ " O.D. | $\frac{3}{8}$ "-24LH | 2-MHF6P |
| 2-MHF9 | $\frac{9}{16}$ " O.D. | $\frac{9}{16}$ "-18LH | 2-MHF9P |
| 2-MXF4 | $\frac{1}{4}$ " O.D. | $\frac{1}{4}$ "-28LH | 2-MXF4P |
| 2-MXF6 | $\frac{3}{8}$ " O.D. | $\frac{3}{8}$ "-24LH | 2-MXF6P |

* Not interchangeable





High Pressure Equipment

Coning and Threading Instructions

Coning Tubing Ends

The coning tool is designed for preparing a "cone" having an included angle of approximately 57 to 59 degrees on the ends of tubing. Operation is as follows:

1. Secure coning tool body in suitable vise.
You may wish to angle the tool in the vise in order to facilitate access to the collet nut and knurled cap.
2. Cut off tubing to desired length and deburr ends.
3. Rotate knurled cap clockwise into tool as far as it will go.
4. "Back off" knurled cap by rotating counterclockwise a number of complete rotations as indicated in the chart below. (A mark on the knurled cap may be useful).

| Tubing Size | "Back Off Turns" |
|-------------|------------------|
| 1/8" O.D. | 3 turns |
| 1/4" O.D. | 4 1/2 turns |
| 3/8" O.D. | 4 1/2 turns |
| 9/16" O.D. | 8 turns |

5. Insert tubing thru collet nut and collet until tubing stops up against inside cutter.
6. Tighten collet nut to secure tubing into position.
7. Turn knurled cap counterclockwise to remove cap and cutter from tool.
8. Apply a very liberal amount of "Sulflo" (sulphur based cutting compound) to the end of the cutter.
9. Screw cap and cutter back into the body until the cutter contacts the end of the tubing.
10. Rotate handle of cutting tool clockwise fairly rapidly with one hand while slowly rotating the knurled cap clockwise with the other hand in order to continuously feed the cutter into the tubing. Do not overly force the cutter against the tubing as it will bind. (You will quickly develop the proper feel). You will need to rotate the knurled cap a complete number of turns as per the chart below in order to complete the cone on the end of the tubing.

| Tubing Size | "Back Off Turns" |
|-------------|------------------|
| 1/8" O.D. | 2 1/2 turns |
| 1/4" O.D. | 3 1/2 turns |
| 3/8" O.D. | 4 turns |
| 9/16" O.D. | 7 1/2 turns |

11. After coning the tubing end, loosen the collet nut and remove tubing from the tool. Remove the knurled cap and cutter from the tool in order to clean off the Sulflo compound and steel chips in preparation for the next tube.

NOTES:

- A. Steps 3 and 4 (on left) are primarily a help in properly positioning the tubing in the tool. As you gain experience with the tool, you will be able to judge the proper position by sight in order to eliminate these steps.
- B. The 1/4" O.D. and 3/8" O.D. tubing sizes are relatively easy to cone. The 1/8" O.D. size is "delicate" (be especially careful not to force the cutter). The 9/16" O.D. size requires the most amount of firmness in the cutting.
- C. As with other tools, it is not uncommon for a collet to "stick" even after the collet nut has been released. Should this occur, simply tap the side of the collet nut firmly with the wrench to release the collet.

Threading the Tubing

The threading tool is designed to put a left hand thread onto the end of the tubing. Operation is as follows:

1. The coning tool (with the knurled cap and cutter removed) provides an ideal way to hold the tubing for the threading operation (see photo).
2. After securing the tubing, apply a liberal amount of Sulflo to the end of the tubing.
3. Place the threading tool (guide bushing side first) onto the tubing.
4. Place the palm of your hand firmly against the center of the threading tool and rotate your wrist counterclockwise. This will help "start" the die onto the tube. After you feel the die start onto the tubing, continue to rotate the threading tool using the handles.
5. Remove the threading tool and clean off Sulflo and chips.

NOTE:

The tubing collar should easily screw onto the tubing. If it feels too tight or loose, the die should be adjusted accordingly. Simply remove the die from the holder by loosening the outer set screw. The small adjustment screw located on the side of the die can be turned to precisely set the die.



High Pressure Equipment

Pressure Vessels and Reactors

High Pressure Equipment Company designs and manufactures a broad range of pressure vessels and reactors for both bench-scale and pilot plant applications. We have over 250 standard reactor designs which address varied size, material, pressure and temperature requirements.

There are many applications that demand ASME approval for work involving pressure vessels. To satisfy this need, HiP produces a variety of pressure vessels and reactors that meet the requirements of the ASME Pressure Vessel Code.

Complementing our standard product offering is our capability to provide a custom reactor designed to meet your specific needs. Our engineering and technical support will help you identify the specific options you need, ranging from exotic materials to unusual sizes and connections, and then incorporate the appropriate approvals, including ASME.









| Index | Page |
|--------------------------------------------------------|-------------|
| Pressure Vessel Selection . . . | 10.2-10.3 |
| O-Ring Seal Reactors | |
| Series OC | 10.4 |
| Confined Gasket Closure Reactors - Series GC | 10.5 |
| Bolted Closure Reactors | 10.6 |
| Clover Leaf Reactors | 10.7 |
| O-Ring Closure Reactors | |
| Series R | 10.8-10.9 |
| Tubular Reactors | |
| Series TOC | 10.10-10.11 |
| Micro Reactors | |
| Series MS | 10.12 |

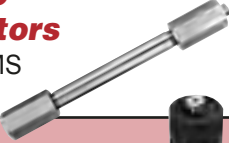

High Pressure Equipment

Reactor Selection Guide

| Reactor Design | Description | Standard Material | Maximum Temperature (degrees F) | Maximum Working Pressure (psi) | Standard Capacity |
|-------------------------------------------------------------------------------------------------------------------------------|--------------------------------------------------------------------------------------------------------------------------------------------------------------------------------------------------|-------------------|-----------------------------------|--------------------------------|----------------------|
| O-ring Seal Series OC  | Simple closure design allows for easy assembly/disassembly and reliable operation. Series OC are economical reactors ideal for low temperature gas or liquid service. | 316SS | 250 | 16,000 | 125 mL to 6,750 mL |
| Confined Gasket Closure Series GC  | Series GC is designed for studying high temperature and pressure reactions. The vessels utilize thrust bolts and a thrust ring to ensure positive seating of the gasket. | 316SS | 800 | 16,000 | 125 mL to 6,750 mL |
| Bolted Closure Series BC  | These versatile reactors are the standard of the industry for applications involving moderate pressure ranges. Standard O-rings may be used in place of the metal gasket for lower temperatures. | 316SS | 650 | 5,000 | 300 mL to 2 gal. |
| Clover Leaf Series CL  | Quick opening cover design needs only one-eighth of a turn rotation for sealing. Ideal for high pressure operations requiring repetitive opening/closing. | 4340 alloy steel | 250 | 30,000 | 1,000 mL to 3,700 mL |
| O-ring Closure Series R  | Designed for extremely high pressure/low temperature operation, series R reactors feature a threaded closure for easy assembly and disassembly. | 4340 alloy steel | 250 | 150,000 | 77 mL to 30 liters |
| Micro Reactors Series MS  | Series MS are fixed bed tubular reactors designed for a variety of applications such as small volume testing of components and miniature scale reaction tests. | 316SS | 800 | 30,000 | 2 mL to 64 mL |
| Tubular Reactors Series TOC  | This line of economical and versatile reactors satisfy many moderate pressure applications. Accumulators can be customized through a variety of options including piston separators. | 304SS | O-ring 250 confined gasket 800 | 10,000 | 50 mL to 15 liters |
| Custom Reactors | HiP makes every reactor to order, allowing for economical and timely customizing. We offer a broad range of exotic metals, sizes and connections to meet virtually any requirement. | — | — | — | — |

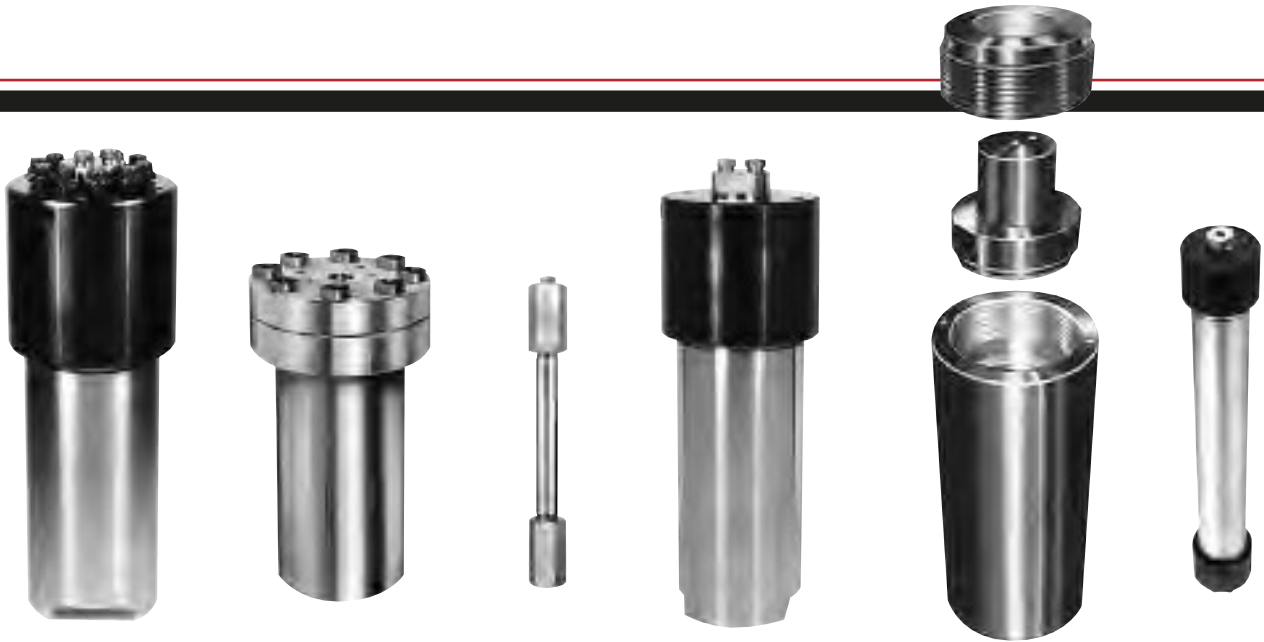

Pressure Vessel Volume Table (cubic inches)

| Inside Depth (inches) | Inside Diameter (inches) | | | | | | | | | | | | |
|-----------------------|--------------------------|-------|--------|-------|--------|-------|-------|-------|-------|-------|-------|-------|-------|
| | 1/2" | 1" | 1 1/2" | 2" | 2 1/2" | 3" | 4" | 5" | 6" | 7" | 8" | 9" | 10" |
| 4" | 0.7856 | 3.142 | 7.068 | 12.57 | 19.63 | 28.27 | 50.26 | 78.54 | 113.1 | 153.9 | 201.1 | 254.5 | 314.2 |
| 6" | 1.178 | 4.712 | 10.60 | 18.85 | 29.45 | 42.41 | 75.40 | 117.8 | 169.6 | 230.9 | 301.6 | 381.7 | 471.2 |
| 8" | 1.571 | 6.283 | 14.14 | 25.13 | 39.27 | 56.55 | 100.5 | 157.1 | 226.2 | 307.9 | 402.1 | 508.9 | 628.4 |
| 10" | 1.964 | 7.854 | 17.67 | 31.42 | 49.09 | 70.69 | 125.7 | 196.3 | 282.7 | 384.8 | 502.6 | 636.2 | 785.2 |
| 12" | 2.357 | 9.425 | 21.21 | 37.70 | 58.90 | 84.82 | 150.8 | 235.6 | 339.3 | 461.8 | 603.2 | 763.4 | 942.4 |
| 14" | 2.749 | 11.00 | 24.74 | 43.98 | 68.72 | 98.96 | 175.9 | 274.9 | 395.8 | 538.8 | 703.7 | 890.6 | 1100 |
| 16" | 3.142 | 12.57 | 28.27 | 50.27 | 78.54 | 113.1 | 201.1 | 314.2 | 452.4 | 615.8 | 804.2 | 1018 | 1257 |
| 18" | 3.535 | 14.14 | 31.81 | 56.55 | 88.36 | 127.2 | 226.2 | 353.4 | 508.9 | 692.7 | 904.8 | 1145 | 1415 |
| 20" | 3.928 | 15.71 | 35.34 | 62.83 | 98.17 | 141.4 | 251.3 | 392.7 | 565.5 | 769.7 | 1005 | 1272 | 1571 |
| 22" | 4.231 | 17.28 | 38.88 | 69.12 | 108.0 | 155.5 | 276.5 | 432.0 | 622.0 | 846.7 | 1106 | 1400 | 1728 |
| 24" | 4.714 | 18.85 | 42.41 | 75.40 | 117.8 | 169.6 | 301.6 | 471.2 | 678.6 | 923.6 | 1206 | 1527 | 1885 |
| 26" | 5.106 | 20.42 | 45.94 | 81.68 | 127.6 | 183.8 | 326.7 | 510.5 | 735.1 | 1001 | 1307 | 1654 | 2042 |
| 28" | 5.499 | 21.99 | 49.48 | 87.96 | 137.4 | 197.9 | 351.8 | 549.8 | 791.7 | 1078 | 1407 | 1781 | 2199 |

Volume Equivalents

1 in³ = 16.39 mL
 1 mL = 0.061 in³
 1 gal = 231 in³ = 0.134 ft³
 1 ft³ = 1728 in³ = 7.481 gal
 1 L = 61.02 in³ = 0.264 gal

Pressure Conversions

| | psi | atm | kg/cm ² |
|--------------------|--------|-------|--------------------|
| psi | 1 | 0.068 | 0.070 |
| atm | 14.696 | 1 | 1.033 |
| kg/cm ² | 14.224 | 0.968 | 1 |



High Pressure Equipment

OC Series O-Ring Seal Reactors



The OC Series provide a simple closure that is reliable and easy to assemble and disassemble. Standard material for the body and cover is Type 316 stainless steel. The standard O-ring material is BUNA-N. Temperature is limited by the O-ring to 250°F.

These reactors are suitable for either gas or liquid service. Capacities range from 125 mL to 6,750 mL.

Standard connections are for 1/4" O.D. high pressure (coned and threaded) tubing (HF4). Models OC-1 and OC-3 have one connection in the cover. All other models have two connections in the cover. Contact factory if other connections and/or locations are preferred.

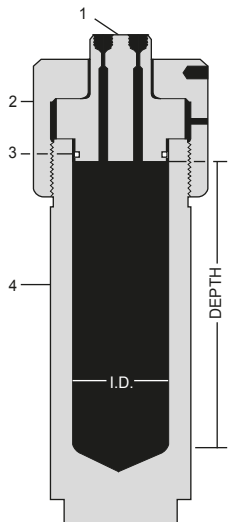

- 1. COVER
 - 2. CAP
 - 3. "O" RING
 - 4. BODY
- 316 S.S.
ALLOY STEEL
BUNA-N
316 S.S.

Series OC Reactors

| Catalog No. | I.D. | O.D. | Inside Depth | Capacity | Material | Working Pressure psi |
|-------------|--------|--------|--------------|----------|----------|----------------------|
| OC-1* | 1" | 2 1/2" | 10" | 125 mL | 316 S.S. | 13,800 |
| OC-3* | 1 1/2" | 2 1/2" | 10" | 280 mL | 316 S.S. | 7,750 |
| OC-5 | 1 1/2" | 4 3/8" | 10" | 280 mL | 316 S.S. | 16,000 |
| OC-7 | 1 1/2" | 4 3/8" | 21" | 600 mL | 316 S.S. | 16,000 |
| OC-9 | 2" | 4 3/8" | 10" | 500 mL | 316 S.S. | 12,500 |
| OC-11 | 2" | 4 3/8" | 21" | 1,040 mL | 316 S.S. | 12,500 |
| OC-13 | 2 1/2" | 4 3/8" | 10" | 800 mL | 316 S.S. | 9,200 |
| OC-15 | 2 1/2" | 4 3/8" | 21" | 1,160 mL | 316 S.S. | 9,200 |
| OC-17 | 3" | 6 7/8" | 10" | 1,150 mL | 316 S.S. | 13,000 |
| OC-19 | 3" | 6 7/8" | 21" | 2,430 mL | 316 S.S. | 13,000 |
| OC-21 | 3 1/2" | 6 7/8" | 10" | 1,575 mL | 316 S.S. | 10,500 |
| OC-23 | 3 1/2" | 6 7/8" | 21" | 3,300 mL | 316 S.S. | 10,500 |
| OC-25 | 4" | 6 7/8" | 10" | 2,060 mL | 316 S.S. | 8,500 |
| OC-27 | 4" | 6 7/8" | 21" | 4,325 mL | 316 S.S. | 8,500 |
| OC-29 | 4 1/2" | 6 7/8" | 10" | 2,600 mL | 316 S.S. | 6,500 |
| OC-31 | 4 1/2" | 6 7/8" | 21" | 5,475 mL | 316 S.S. | 6,500 |
| OC-33 | 5" | 6 7/8" | 10" | 3,200 mL | 316 S.S. | 5,000 |
| OC-35 | 5" | 6 7/8" | 21" | 6,750 mL | 316 S.S. | 5,000 |

* One (1) opening only in cover

Confined Gasket Closure Reactors

The Confined Gasket Closure reactors listed below are ideally suited for use at elevated temperatures and pressures as shown in the chart. Thrust bolts with a hardened thrust ring are supplied to insure positive seating of the gasket. Torque required on thrust bolts will range from 70 to 125 foot pounds, depending upon size of reactor, pressure, temperature and media being pressurized. Torquing of bolts should be done in a crisscross staggered pattern to insure uniform seating. A commercial high temperature lubricant should always be applied to the bolt threads and outside cap threads to facilitate removal of the closure.

Standard material for the body, cover and gasket is Type 316 stainless steel. These reactors are suitable for either gas or liquid service and capacities range from 125mL to 6,750 mL.

Standard connections supplied are for 1/4" O.D. high pressure (coned and threaded) tubing (HF4). Models GC-1 and GC-3 have one connection in the cover. All other models have two connections in the cover and a thermowell that extends two-thirds of the inside depth.

Included with each reactor are eye bolts for lifting and necessary collars and glands for the connections. Vise flats are machined on to the bottom of the body for securing while assembling or disassembling closure.



Series GC Reactors

| Catalog No. | I.D. | O.D. | Inside Depth | Capacity | Material | Working Pressure (psi) | | |
|-------------|--------|--------|--------------|----------|----------|------------------------|--------|--------|
| | | | | | | 100°F | 650°F | 800°F |
| GC-1 | 1" | 2 1/2" | 10" | 125 mL | 316 S.S. | 13,800 | 12,500 | 12,000 |
| GC-3 | 1 1/2" | 2 1/2" | 10" | 280 mL | 316 S.S. | 7,750 | 7,000 | 6,900 |
| GC-5 | 1 1/2" | 4 3/8" | 10" | 280 mL | 316 S.S. | 16,000 | 14,500 | 14,000 |
| GC-7 | 1 1/2" | 4 3/8" | 21" | 600 mL | 316 S.S. | 16,000 | 14,500 | 14,000 |
| GC-9 | 2" | 4 3/8" | 10" | 500 mL | 316 S.S. | 12,500 | 11,400 | 11,000 |
| GC-11 | 2" | 4 3/8" | 21" | 1,040 mL | 316 S.S. | 12,500 | 11,400 | 11,000 |
| GC-13 | 2 1/2" | 4 3/8" | 10" | 800 mL | 316 S.S. | 9,200 | 8,400 | 8,200 |
| GC-15 | 2 1/2" | 4 3/8" | 21" | 1,160 mL | 316 S.S. | 9,200 | 8,400 | 8,200 |
| GC-17 | 3" | 6 7/8" | 10" | 1,150 mL | 316 S.S. | 13,000 | 11,000 | 10,000 |
| GC-19 | 3" | 6 7/8" | 21" | 2,430 mL | 316 S.S. | 13,000 | 11,000 | 10,000 |
| GC-21 | 3 1/2" | 6 7/8" | 10" | 1,575 mL | 316 S.S. | 10,500 | 9,000 | 8,000 |
| GC-23 | 3 1/2" | 6 7/8" | 21" | 3,300 mL | 316 S.S. | 10,500 | 9,000 | 8,000 |
| GC-25 | 4" | 6 7/8" | 10" | 2,060 mL | 316 S.S. | 8,500 | 7,300 | 6,500 |
| GC-27 | 4" | 6 7/8" | 21" | 4,325 mL | 316 S.S. | 8,500 | 7,300 | 6,500 |
| GC-29 | 4 1/2" | 6 7/8" | 10" | 2,600 mL | 316 S.S. | 6,500 | 5,500 | 5,000 |
| GC-31 | 4 1/2" | 6 7/8" | 21" | 5,475 mL | 316 S.S. | 6,500 | 5,500 | 5,000 |
| GC-33 | 5" | 6 7/8" | 10" | 3,200 mL | 316 S.S. | 5,000 | 4,300 | 4,000 |
| GC-35 | 5" | 6 7/8" | 21" | 6,750 mL | 316 S.S. | 5,000 | 4,300 | 4,000 |

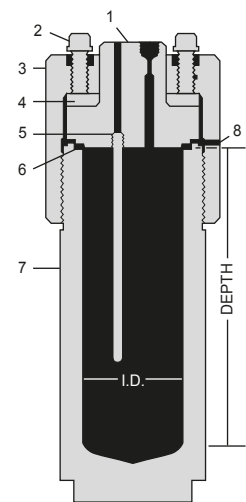

- 1. COVER 316 S.S. COMM.
- 2. SET SCREW ALLOY ST'L
- 3. CAP TOOL ST'L
- 4. THRUST RING COPPER
- 5. GASKET 316 S.S.
- 6. GASKET 316 S.S.
- 7. BODY 316 S.S.
- 8. WEEP HOLE



High Pressure Equipment



Bolted Closure Reactors

The Bolted Closure Reactors are designed for use up to 650°F (343°C) at the working pressures indicated. Standard material for the body, cover and gasket is Type 316 stainless steel. Standard O-rings may be used in place of the metal gasket when temperatures permit.

Standard connections include two high pressure (coned and threaded) tubing connections for 1/4" O.D. tubing (HF4) located in the cover. Contact factory if other connections and/or locations are preferred.

Other items available include:

- Heating mantle. Removable quartz fabric cylinder column type. 110 volt, single phase. Bolted closure reactors are supplied with mounting bolt holes on the bottom surface.
- Thermowell for use with 1/16" thermocouple
- Safety head located in side flange with rupture disc (see Page 3.7)

1. PRESSURE CONNECTION (2)
2. SOCKET CAP SCREW
3. COVER
4. GASKET
5. MAIN SEAL
6. BODY
7. THERMOCOUPLE WELL*
8. SAFETY HEAD*

* SUPPLIED AS EXTRA WHEN SPECIFIED

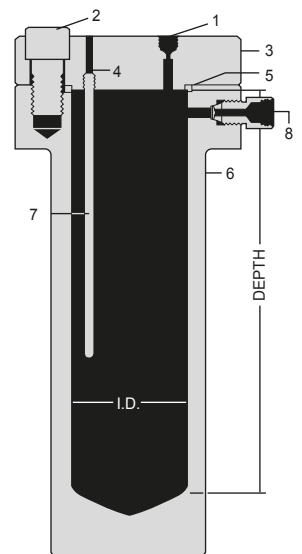

Bolted Closure Reactors

| Catalog No. | Capacity | Working Pressure psi | Temperature Rating °F | Inside Diameter | Inside Depth | Approx. Weight (pounds) | Approx. Torque (ft-lb) per Bolt | Material |
|-------------|----------|----------------------|-----------------------|-----------------|--------------|-------------------------|---------------------------------|----------|
| BC-1 | 300 mL | 5,000 | 650 | 2" | 6" | 21 | 40 | 316 S.S. |
| BC-2 | 1 liter | 5,000 | 650 | 3" | 9" | 50 | 75 | 316 S.S. |
| BC-3 | 2 liter | 5,000 | 650 | 3 1/2" | 12 1/2" | 68 | 105 | 316 S.S. |
| BC-4 | 1 gallon | 3,000 | 650 | 5" | 12" | 97 | 105 | 316 S.S. |
| BC-5 | 1 gallon | 5,000 | 650 | 5" | 12" | 152 | 175 | 316 S.S. |
| BC-6 | 2 gallon | 3,000 | 650 | 6 1/2" | 14" | 245 | 140 | 316 S.S. |

Clover Leaf Reactors

The "Clover Leaf" Closure Reactors provide maximum ease for quick opening or closing of the cover. The cover is simply inserted into the body and then rotated one-eighth of a turn. A safety locking pin is provided to insure that the cover is properly positioned and locked.

Standard material of construction for these reactors is heat treated 4340 alloy steel. Standard connections include two high pressure (coned and threaded) $\frac{1}{4}$ " O.D. tubing connections (HF4).

Mounting holes are provided in the top and bottom of the body for securing or lifting.



1. LOCK PIN
2. COVER
3. O-RING
4. BODY

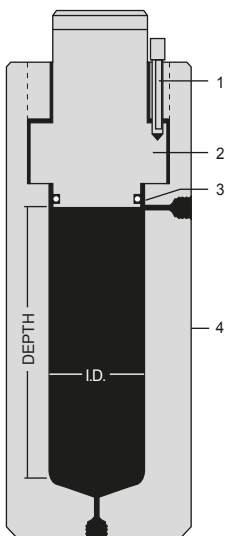

Clover Leaf Closure Reactors

| Catalog No. | Inside Diameter | Outside Diameter | Inside Depth | Working Pressure psi | Temperature Rating °F | Capacity | Material |
|----------------------|-----------------|-------------------|------------------|----------------------|-----------------------|----------------------------------|-------------|
| CL-1 CL-2 CL-3 | 3" | 6 $\frac{1}{2}$ " | 9" 18" 22" | 30,000 | 250 | 1,000 mL 2,000 mL 2,500 mL | Alloy Steel |
| CL-8 CL-9 | 4" | 9 $\frac{1}{2}$ " | 9" 18" | 30,000 | 250 | 1,850 mL 3,700 mL | Alloy Steel |



High Pressure Equipment

Series "R" Reactors O-Ring Closure

The Series "R" O-ring Closure Reactors are easily assembled and disassembled with minimal torque required for complete engagement.

Material of construction for standard models is Type 4340 alloy steel (or equivalent) properly heat treated for use at elevated pressures. (Some models can be provided in stainless steel construction at reduced pressures — consult factory).

Sealing is accomplished by a highly reliable combination of O-ring and separate metal back-up ring. The wedge shaped back-up ring is designed to expand and contract as pressure increases or decreases. Consequently, the O-ring is continuously confined with no clearance for extrusion. Minimal initial torque is required to effect a positive seal.

Temperature on these vessels must be restricted to 250°F maximum, due to the BUNA-N (nitrile) O-ring.
(continued on page 10.9)



O-Ring Closure Reactors (one piece cover)

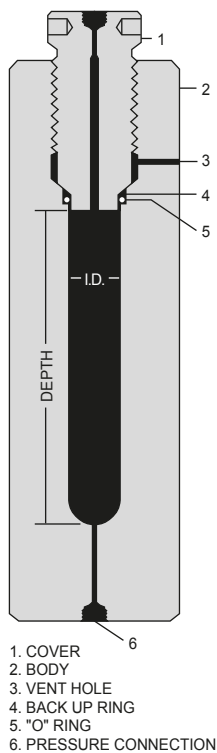

| I.D. | O.D. | Pressure Rating psi | Material | Inside Depth | | | | | |
|--------|---------|---------------------|--------------------------------|--------------|-------------|-------------|-------------|---------------------------------------------------------------------------------------|-----------|
| | | | | 6" | 10" | 12" | 16" | 20" | 24" |
| 1" | 3 1/8" | 30,000 | 4340 Alloy Steel or equivalent | R1-6-30 | R1-10-30 | R1-12-30 | R1-16-30 |  | |
| | 3 1/2" | 40,000 | | R1-6-40 | R1-10-40 | R1-12-40 | R1-16-40 | | |
| | 4 1/4" | 60,000 | | R1-6-60 | R1-10-60 | R1-12-60 | R1-16-60 | | |
| | 5 1/2" | 100,000 | | R1-6-100 | R1-10-100 | R1-12-100 | R1-16-100 | | |
| | 6 3/4" | 150,000 | | R1-6-150 | R1-10-150 | R1-12-150 | R1-16-150 | | |
| 1 1/2" | 3 5/8" | 20,000 | 4340 Alloy Steel or equivalent | R1.5-6-20 | R1.5-10-20 | R1.5-12-20 | R1.5-16-20 | | |
| | 4 1/8" | 30,000 | | R1.5-6-30 | R1.5-10-30 | R1.5-12-30 | R1.5-16-30 | | |
| | 4 3/4" | 40,000 | | R1.5-6-40 | R1.5-10-40 | R1.5-12-40 | R1.5-16-40 | | |
| | 6 1/2" | 60,000 | | R1.5-6-60 | R1.5-10-60 | R1.5-12-60 | R1.5-16-60 | | |
| | 8" | 100,000 | | R1.5-6-100 | R1.5-10-100 | R1.5-12-100 | R1.5-16-100 | | |
| | 10 1/2" | 150,000 | | R1.5-6-150 | R1.5-10-150 | R1.5-12-150 | R1.5-16-150 | | |
| 2" | 4 1/4" | 20,000 | 4340 Alloy Steel or equivalent | R2-6-20 | R2-10-20 | R2-12-20 | R2-16-20 | R2-20-20 | R2-24-20 |
| | 5" | 30,000 | | R2-6-30 | R2-10-30 | R2-12-30 | R2-16-30 | R2-20-30 | R2-24-30 |
| | 6 1/2" | 40,000 | | R2-6-40 | R2-10-40 | R2-12-40 | R2-16-40 | R2-20-40 | R2-24-40 |
| | 8 1/2" | 60,000 | | R2-6-60 | R2-10-60 | R2-12-60 | R2-16-60 | R2-20-60 | R2-24-60 |
| | 12" | 100,000 | | R2-6-100 | R2-10-100 | R2-12-100 | R2-16-100 | R2-20-100 | R2-24-100 |



Included with each vessel is a Tony Bar for removal of the cover nut and necessary eye bolt holes for lifting of the body and components. Outer surfaces are blackened to prevent rusting.

Vent holes are provided to prevent pressure build up behind the closure in the event of a worn or damaged seal.

Connections include a top and bottom high pressure coned and threaded 1/4" O.D. (HF4) tubing connection. Other sizes or locations for connections can easily be provided when preferred. Consult factory.

Closures are designed in one-piece (cover) for vessels up to 2" I.D. and two-piece (cover and main nut) for vessels larger than 2" I.D.

O-Ring Closure Reactors (two piece cover)

| I.D. | O.D. | Pressure Rating psi | Material | Inside Depth | | | | | |
|---------|---------|---------------------|--------------------------------|--------------|-----------|-----------|-----------|-----------|-----------|
| | | | | 6" | 10" | 12" | 16" | 20" | 24" |
| 3" | 6" | 20,000 | 4340 Alloy Steel or equivalent | R3-6-20 | R3-10-20 | R3-12-20 | R3-16-20 | R3-20-20 | R3-24-20 |
| | 7" | 30,000 | | R3-6-30 | R3-10-30 | R3-12-30 | R3-16-30 | R3-20-30 | R3-24-30 |
| | 8 1/2" | 40,000 | | R3-6-40 | R3-10-40 | R3-12-40 | R3-16-40 | R3-20-40 | R3-24-40 |
| | 11 1/2" | 60,000 | | R3-6-60 | R3-10-60 | R3-12-60 | R3-16-60 | R3-20-60 | R3-24-60 |
| | 15" | 100,000 | | R3-6-100 | R3-10-100 | R3-12-100 | R3-16-100 | R3-20-100 | R3-24-100 |
| 4" | 8" | 20,000 | | R4-6-20 | R4-10-20 | R4-12-20 | R4-16-20 | R4-20-20 | R4-24-20 |
| | 9 1/4" | 30,000 | | R4-6-30 | R4-10-30 | R4-12-30 | R4-16-30 | R4-20-30 | R4-24-30 |
| | 11" | 40,000 | | R4-6-40 | R4-10-40 | R4-12-40 | R4-16-40 | R4-20-40 | R4-24-40 |
| | 13" | 50,000 | | R4-6-50 | R4-10-50 | R4-12-50 | R4-16-50 | R4-20-50 | R4-24-50 |
| | 15" | 60,000 | | R4-6-60 | R4-10-60 | R4-12-60 | R4-16-60 | R4-20-60 | R4-24-60 |
| 5" | 9 1/4" | 20,000 | | R5-6-20 | R5-10-20 | R5-12-20 | R5-16-20 | R5-20-20 | R5-24-20 |
| | 11 1/4" | 30,000 | | R5-6-30 | R5-10-30 | R5-12-30 | R5-16-30 | R5-20-30 | R5-24-30 |
| | 13 1/4" | 40,000 | | R5-6-40 | R5-10-40 | R5-12-40 | R5-16-40 | R5-20-40 | R5-24-40 |
| | 15 1/4" | 50,000 | | R5-6-50 | R5-10-50 | R5-12-50 | R5-16-50 | R5-20-50 | R5-24-50 |
| | 6" | 9 1/2" | | 10,000 | R6-6-10 | R6-10-10 | R6-12-10 | R6-16-10 | R6-20-10 |
| 11 1/2" | | 20,000 | | R6-6-20 | R6-10-20 | R6-12-20 | R6-16-20 | R6-20-20 | R6-24-20 |
| 13 1/4" | | 30,000 | | R6-6-30 | R6-10-30 | R6-12-30 | R6-16-30 | R6-20-30 | R6-24-30 |
| 15" | | 40,000 | | R6-6-40 | R6-10-40 | R6-12-40 | R6-16-40 | R6-20-40 | R6-24-40 |
| | | 10 3/4" | | 10,000 | R7-6-10 | R7-10-10 | R7-12-10 | R7-16-10 | R7-20-10 |
| 7" | 13" | 20,000 | | R7-6-20 | R7-10-20 | R7-12-20 | R7-16-20 | R7-20-20 | |
| | 15 1/4" | 30,000 | | R7-6-30 | R7-10-30 | R7-12-30 | R7-16-30 | R7-20-30 | |
| | | 12 1/2" | | 10,000 | R8-6-10 | R8-10-10 | R8-12-10 | R8-16-10 | R8-20-10 |
| 8" | 14 1/4" | 20,000 | | R8-6-20 | R8-10-20 | R8-12-20 | R8-16-20 | R8-20-20 | |
| | 13" | 10,000 | | R9-6-10 | R9-10-10 | R9-12-10 | R9-16-10 | R9-20-10 | |
| 10" | 14 3/4" | 10,000 | | R10-6-10 | R10-10-10 | R10-12-10 | R10-16-10 | R10-20-10 | |

1. PRESSURE CONNECTION
2. MAIN UNIT NUT
3. BODY
4. VENT HOLE
5. COVER
6. BACK UP RING
7. "O" RING

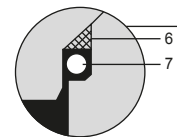
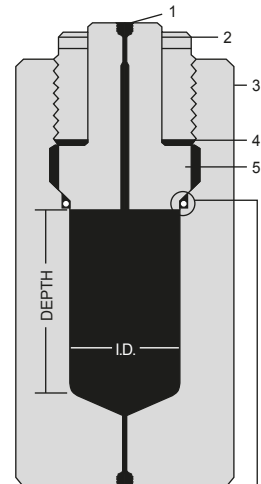

SEALING DETAIL



High Pressure Equipment

Tubular Series Reactors

The Tubular Series Reactors are double ended pressure vessels made from commercial quality cold drawn Type 304 stainless steel seamless tubing. Outside (non-wetted) caps are alloy steel. These are both economical and versatile vessels proven in demand for many applications. Finishes are commercial cold drawn finishes, with honed internal finishes.

Standard sizes are shown in the chart on page 10.11, but special lengths and modifications are easily supplied on request. One pressure connection for $\frac{1}{4}$ " O.D. high pressure coned and threaded tubing at each end is standard. Additional end connections are possible on the larger size models. Also, side connections and end cover thermowells can be supplied when required. Consult factory for special requirements.

O-Ring Closures are standard when temperatures do not exceed 250°F. This is an easily assembled closure requiring minimal torque for positive sealing. The standard O-ring material used is BUNA-N (nitrile) with various other O-ring materials available on request.

Confined Gasket Closures are available for temperatures up to 800°F. A 15% reduction in the listed working pressure is required at this elevated temperature level. These closures utilize a metal gasket (304 stainless steel) which can be torqued down for positive sealing. Torque requirements on the thrust bolts will range from 60 to 110 foot pounds depending on size, pressure, temperature and media being pressurized. These confined gasket closures are available for all models except the TOC1 and TOC3 series. When ordering, simply specify catalog number and add suffix "(W/Gasket)".

Piston Separators can be supplied with the O-ring closure vessels for use as compression cylinders. These are ideal for separating a liquid from a gas and other similar applications. The tubing body is supplied with a honed inside diameter surface to accommodate the piston. When ordering, simply specify catalog number and add suffix "(W/Piston)".



Tubular Series Reactors

| Tubing Size | | Pressure Rating psi | Material | Catalog Number (O-Ring Closure) | | | |
|-------------|------|------------------------|--------------------------------------------|---------------------------------|----------|----------|----------|
| I.D. | O.D. | | | 20"IL | 40"IL | 60"IL | 72"IL |
| 1" | 1½" | 5,000 | Body 304 S.S. Covers 316 S.S. | TOC1-20 | TOC1-40 | TOC1-60 | TOC1-72 |
| ¾" | 1½" | 10,000 | | TOC3-20 | TOC3-40 | TOC3-60 | TOC3-72 |
| 1¼" | 2" | 6,000 | | TOC5-20 | TOC5-40 | TOC5-60 | TOC5-72 |
| 1" | 2" | 10,000 | | TOC7-20 | TOC7-40 | TOC7-60 | TOC7-72 |
| 1¾" | 2½" | 4,000 | | TOC9-20 | TOC9-40 | TOC9-60 | TOC9-72 |
| 1½" | 2½" | 7,000 | | TOC11-20 | TOC11-40 | TOC11-60 | TOC11-72 |
| 2¼" | 3" | 3,000 | | TOC13-20 | TOC13-40 | TOC13-60 | TOC13-72 |
| 2" | 3" | 5,000 | | TOC15-20 | TOC15-40 | TOC15-60 | TOC15-72 |
| 2¾" | 3½" | 3,000 | | TOC17-20 | TOC17-40 | TOC17-60 | TOC17-72 |
| 2½" | 3½" | 4,500 | | TOC19-20 | TOC19-40 | TOC19-60 | TOC19-72 |
| 3¼" | 4" | 2,500 | | TOC21-20 | TOC21-40 | TOC21-60 | TOC21-72 |
| 3" | 4" | 4,000 | | TOC23-20 | TOC23-40 | TOC23-60 | TOC23-72 |
| 3½" | 4½" | 3,000 | | TOC25-20 | TOC25-40 | TOC25-60 | TOC25-72 |
| 3" | 4½" | 5,000 | | TOC27-20 | TOC27-40 | TOC27-60 | TOC27-72 |
| 4" | 5" | 3,000 | | TOC29-20 | TOC29-40 | TOC29-60 | TOC29-72 |
| 3½" | 5" | 5,000 | | TOC31-20 | TOC31-40 | TOC31-60 | TOC31-72 |

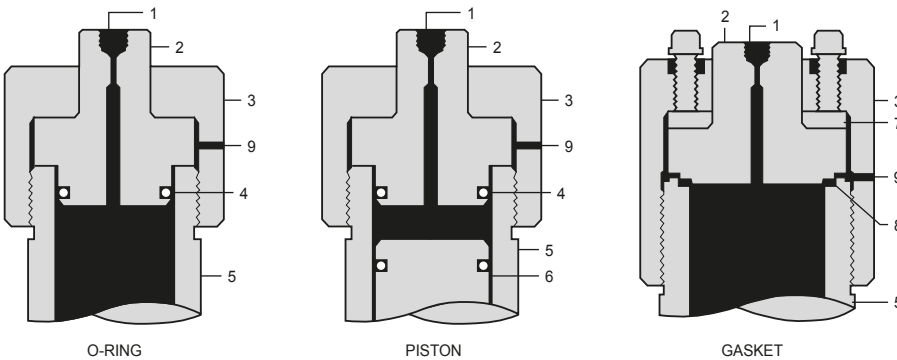
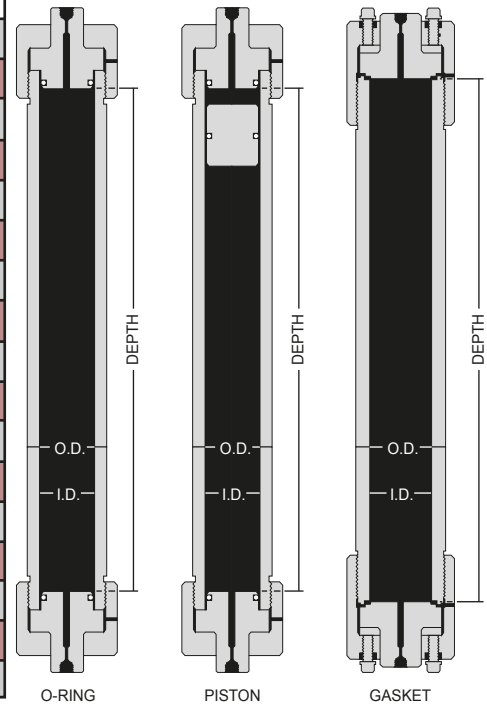

1. PRESSURE CONNECTION
2. COVER
3. CAP
4. "O" RING
5. BODY (BOTH ENDS ALIKE)
6. PISTON
7. THRUST RING
8. GASKET
9. WEEP HOLE

How To Order Tubular Series Reactors

With O-Ring Closure:

Specify catalog number, see ordering table above.

Note: Use of Buna-N O-ring limits maximum working temperature to 250°F. For higher temperatures to 800°F, order gasket closure.

With Piston Separators:

Specify catalog number, see ordering table above and add "(W/Piston)" as suffix.

Because of temperature limitations pistons are not normally ordered in combination with the gasket closure.

With Gasket Closure:

Specify catalog number, see ordering table above and add "(W/Gasket)" as suffix.
* Gasket closure is not available on 1½" O.D. tubing size vessels.

Example:
TOC15-20 (W/Gasket).



High Pressure Equipment

Series "MS" Micro Reactors

The Micro Reactors shown are designed for numerous applications including small volume testing of components and miniature scale reaction tests.

Standard material of construction is Type 316 stainless steel.

Operation at temperatures up to 800°F is made possible by the metal to metal seal construction. Working pressures should be reduced by approximately 15% at the maximum 800°F temperature level.

Connections are for 1/4" O.D. high pressure coned and threaded tubing (HF4). One connection is provided at each end. Other sizes or types of connections can be provided. Thermocouples can easily be installed with the use of thermocouple adapters (refer to section 8.0).

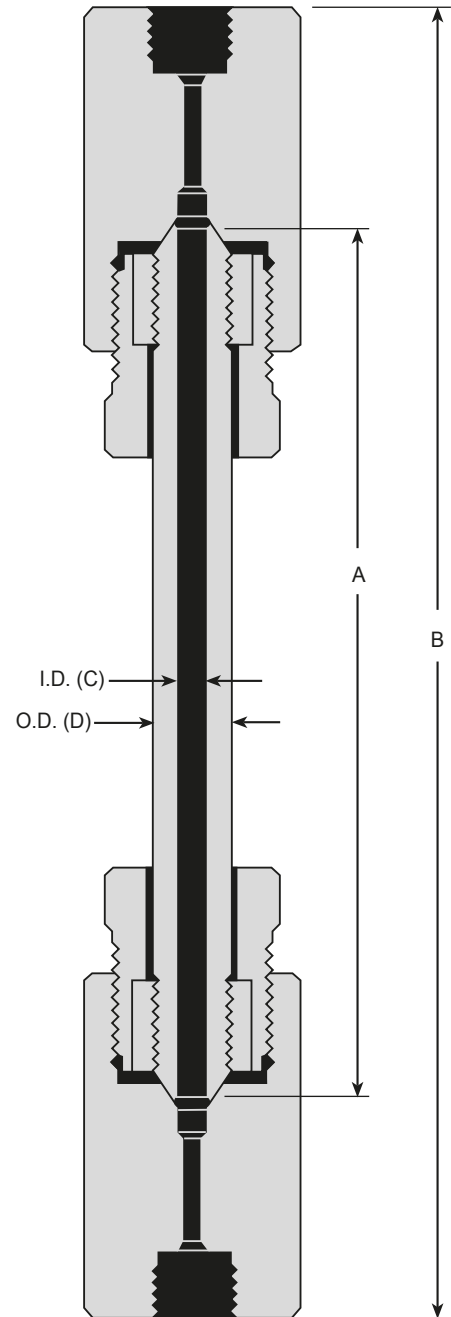

| Catalog No. | Capacity | Working Pressure psi | (C) Inside Diameter | (D) Outside Diameter | (A) Inside Depth | (B) Overall Length |
|-------------|-----------|----------------------|---------------------|----------------------|------------------|--------------------|
| MS-1 | 2 mL | 60,000 | 3/16" | 9/16" | 4" | 7" |
| MS-2 | 3 mL | | | | 6" | 9" |
| MS-3 | 4 mL | | | | 8" | 11" |
| MS-4 | 5 mL | | | | 10" | 13" |
| MS-5 | 6 mL | | | | 12" | 15" |
| MS-11 | 5 mL | 20,000 | 5/16" | 9/16" | 4" | 6 1/2" |
| MS-12 | 7 1/2 mL | | | | 6" | 8 1/2" |
| MS-13 | 10 mL | | | | 8" | 10 1/2" |
| MS-14 | 12 1/2 mL | | | | 10" | 12 1/2" |
| MS-15 | 15 mL | | | | 12" | 14 1/2" |
| MS-16 | 24 mL | 20,000 | 9/16" | 1" | 6" | 9" |
| MS-17 | 41 mL | | | | 10" | 13" |
| MS-18 | 65 mL | | | | 16" | 19" |
| MS-19 | 81 mL | | | | 20" | 23" |



High Pressure Equipment

Pumping Systems, Intensifiers, Gas Boosters and High Pressure Generators

High Pressure Equipment Company produces a number of components and systems for general industrial, elevated pressure applications.

Pumping Systems are air operated, hydraulic systems capable of producing output pressures up to 50,000 psi. These pumping systems are complete, self-contained and ready to operate; just connect to shop air supply.

Hydraulic Intensifiers feature a compression ratio of 10 to 1, which allows for output pressures as high as 150,000 psi when used in conjunction with a commercially available lower pressure pump (15,000 psi).

Gas Boosters and gas booster systems are an excellent method for increasing the pressures or flow rates for a variety of gases. These units offer compression ratios as high as 30 to 1 and output pressures up to 60,000 psi.

High Pressure Generators are manually operated piston screw pumps for compressing liquids and some gases in small volumes to develop pressure.



Index

Page

| | |
|--------------------------------|-----------|
| Pumping Systems | 11.2-11.4 |
| Intensifiers | 11.5 |
| Gas Boosters | 11.6-11.7 |
| High Pressure Generators . . . | 11.8-11.9 |



High Pressure Equipment

Air Operated Hydraulic Pumping Systems to 50,000 psi



- Model PS-10: 10,000 psi
- Model PS-20: 20,000 psi
- Model PS-30: 30,000 psi
- Model PS-40: 40,000 psi
- Model PS-50: 50,000 psi
- Model PS-90: 90,000 psi

High Pressure air operated hydraulic pumping systems are complete, self-contained units and ready to operate. Just hook up standard shop air supply (maximum 100 psi) to connection supplied on the side of the console. Discharge capacities range to 64 in³/min.

Standard Features

System includes hydraulic oil reservoir, oil filter, air operated hydraulic pump, pressure gauge, panel mounted high pressure valves, safety head assembly, panel mounted air regulator and gauge and air line filter and lubricator.

All components are enclosed in a steel console with only the back exposed.

Dimensions of standard systems are 26" wide, 24" deep and 40" high.

System Capabilities

The output pressure is predetermined by adjustment to the air regulator setting.

Output pressure is maintained constantly and pump compensates for pressure drops or losses.

Hydraulic input is gravity fed, however, if pump is used alone, the feed can be pressurized to the limit of the pump.

Within the pump the large diameter air piston drives a smaller piston to provide fluid flow at high pressure.

Air consumption will be approximately 56 CFM of free air at 100 psi input.

Reservoir = 4 gallon capacity, do not pressurize.

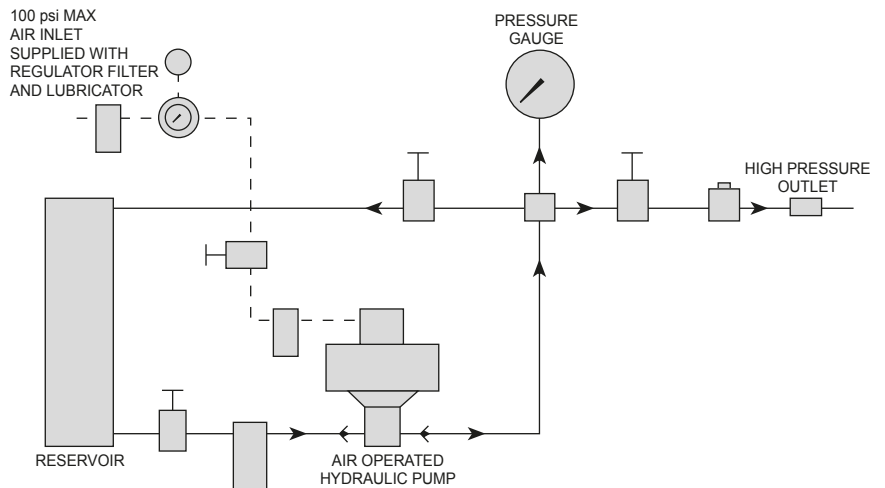

Standard Pumping System Specifications

Approximate Air to Hydraulic Pressure Ratio — Static Conditions

| | Model No. | Air psi | | | | | | | | | | |
|------------------------|-----------|----------------|--------|--------|--------|--------|--------|--------|--------|--------|--------|--------|
| | | 10 | 20 | 30 | 40 | 50 | 60 | 70 | 80 | 90 | 100 | 110 |
| Hydraulic Pressure psi | PS-10 | 1,500 | 3,200 | 5,200 | 7,100 | 9,000 | 10,800 | 12,500 | 14,500 | 16,300 | 18,000 | 19,800 |
| | PS-20 | 3,000 | 6,000 | 9,500 | 12,600 | 16,000 | 19,100 | 22,300 | 25,600 | 29,000 | 32,300 | 35,600 |
| | PS-30 | 4,000 | 8,800 | 13,700 | 18,000 | 22,500 | 27,000 | 31,500 | 36,500 | 41,400 | 45,800 | 50,300 |
| | PS-40 | 6,000 | 13,000 | 21,000 | 27,000 | 34,000 | 40,500 | 46,000 | 52,000 | 59,000 | 65,000 | 70,000 |
| | PS-50 | 6,000 | 13,000 | 21,000 | 27,000 | 34,000 | 40,500 | 46,000 | 52,000 | 59,000 | 65,000 | 70,000 |
| | PS-90 | Uses Dual Pump | | N/A | N/A | N/A | N/A | N/A | N/A | N/A | N/A | N/A |

Approximate Rate of Discharge — CIPM

| Model → | | PS-10 | | | PS-20 | | | PS-30 | | | PS-40 | | | PS-50 | | |
|------------|------------|-------|----|-----|-------|----|-----|-------|----|-----|-------|----|-----|-------|----|-----|
| Air psi → | | 60 | 80 | 100 | 60 | 80 | 100 | 60 | 80 | 100 | 60 | 80 | 100 | 60 | 80 | 100 |
| Pressure → | 10,000 psi | 27 | 52 | 64 | 31 | 40 | 44 | 28 | 33 | 35 | 19 | 23 | 24 | 19 | 23 | 24 |
| | 30,000 psi | 0 | 0 | 0 | 0 | 0 | 14 | 0 | 16 | 21 | 12 | 15 | 17 | 12 | 15 | 17 |
| | 40,000 psi | 0 | 0 | 0 | 0 | 0 | 0 | 0 | 0 | 14 | 2 | 12 | 15 | 2 | 12 | 15 |
| | 50,000 psi | 0 | 0 | 0 | 0 | 0 | 0 | 0 | 0 | 0 | 0 | 6 | 11 | 0 | 6 | 11 |



High Pressure Equipment

150,000 psi Pumping System

Model PS-150



The Model PS-150 Pumping System is designed for generating hydraulic pressure up to 150,000 psi by means of an air operated hydraulic pump and an intensifier. The 10 to 1 ratio intensifier is fully illustrated on facing page 11.5. This system is complete and ready to operate requiring only the connection of an air supply of approximately 80 psi.

The steel console is 26" wide, 24" deep, 40" high and includes manual valves, air regulator, filter and lubricator, air gauge, high pressure gauge, reservoir, oil filter, pump (0-16,000 psi), related high pressure tubing and fittings.

The 0-20,000 psi pressure gauge is connected to the low pressure side of the intensifier which has a ratio of 10 to 1. Pressure on the high pressure side of the intensifier is thus determined by multiplying the gauge reading by 10. A small variation must be allowed for friction from the intensifier packing.

The air operated hydraulic pump pressurizes the system to 16,000 psi with valves "A" and "B" closed and the intensifier piston is automatically positioned to the low pressure end of its stroke. With valves "A" and "C" closed, valve "B" is opened to allow the pump to pressurize the low pressure end of the intensifier. The fluid in the high pressure end of the intensifier is thus pressurized with a 10 to 1 ratio. If the intensifier reaches the end of its stroke before the desired pressure is achieved, the intensifier may be recycled. The intensifier output is approximately 1.2 cubic inches per stroke.

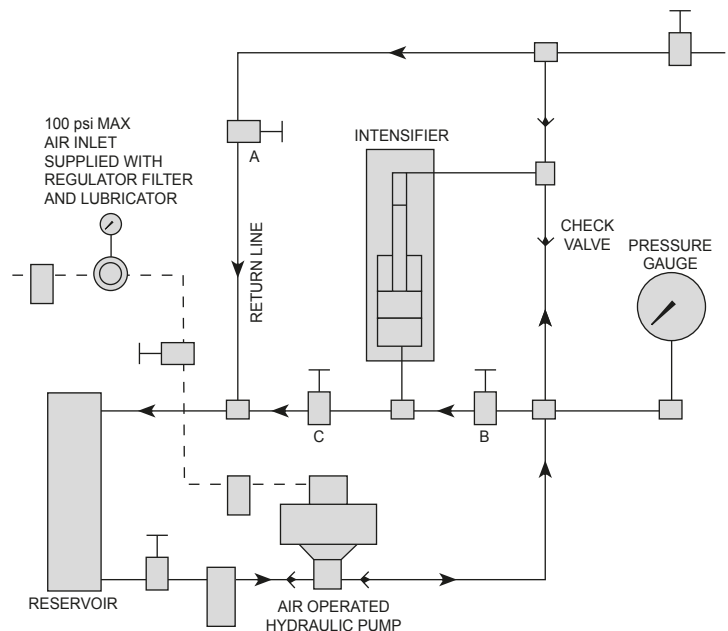

150,000 psi Hydraulic Intensifiers

The 150,000 psi Hydraulic Intensifier is designed with a ratio of areas on the two pistons of 10 to 1. Consequently, pressures up to 150,000 psi can be achieved by using a commercially available lower pressure (15,000 psi) pump.

Operation of this intensifier is illustrated in the typical installation shown in the schematic on facing page 11.4.

Material of construction for the pressure containing parts is 4340 alloy steel (or equivalent) properly heat treated for use at elevated pressures. Only non-corrosive type fluids should be used. The high pressure packing is housed in a separate removable stuffing box. This design permits improved concentricity and facilitates close tolerance machining of the packing area.

Capacity per stroke at the high pressure end is 1.2 cubic inches. Capacity at the low pressure end is 12.6 cubic inches per stroke. Piston travel is 4 inches. Weight is approximately 150 pounds.

Standard connections are for $\frac{1}{4}$ " O.D. tubing (HF4) on the low pressure end and $\frac{3}{8}$ " O.D. x $\frac{1}{16}$ " I.D. tubing (XF6) on the high pressure end.

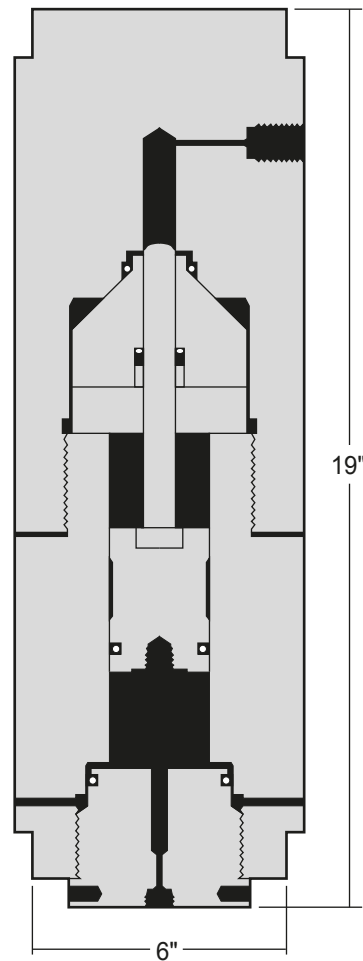



High Pressure Equipment

Gas Boosters

MODEL GBS - 30

30,000 psi Gas Booster System
(One-to-one ratio — 112 cubic inch
per stroke displacement)
(17-4PH stainless steel construction)

MODEL GBS - 60

60,000 psi Gas Booster System
(Thirty-to-one ratio — 4.7 cubic inch
per stroke displacement)
(4340 alloy steel construction)



The Model GBS-30 and GBS-60 Gas Booster Systems are complete and ready to operate. All that is required is an air supply for the pump (approximately 70 psi) and a commercially available container of compressed gas.

The steel console is 26" wide, 24" deep, 40" high and includes manual valves, air regulator, filter and lubricator, air gauge, high pressure gauge, reservoir, oil filter, pump, gas booster and related high pressure tubing and fittings.

Operation is by means of an air operated hydraulic pump which pressurizes one end of the gas booster which then compresses the gas in the opposite end of the booster. To accomplish this, the gas inlet valve is opened to permit gas to fill the gas end of the booster. Check valves are provided to permit gas flow in one direction only. With the gas outlet valve open, the hydraulic pump is operated in order to pressurize the hydraulic end of the booster. Thus, the gas is compressed in the booster. If required pressure is not reached by the end of the stroke, the gas booster can easily be recycled for additional strokes.

Note the gauge on these systems is connected to the hydraulic side of the booster. On the Model GBS-30 which has a 1 to 1 ratio, there is a direct reading of the pressure in the gas end of the booster. The Model GBS-60 has a 30 to 1 ratio and the gauge will accordingly indicate a reading of one-thirtieth (1/30) of the actual pressure in the gas end of the booster. An additional gauge can be furnished for connection to the gas end of the booster to provide direct pressure readings of the gas pressure.

Details of the gas boosters are shown on facing page 11.7.

These systems should not be used with hydrogen or oxygen.

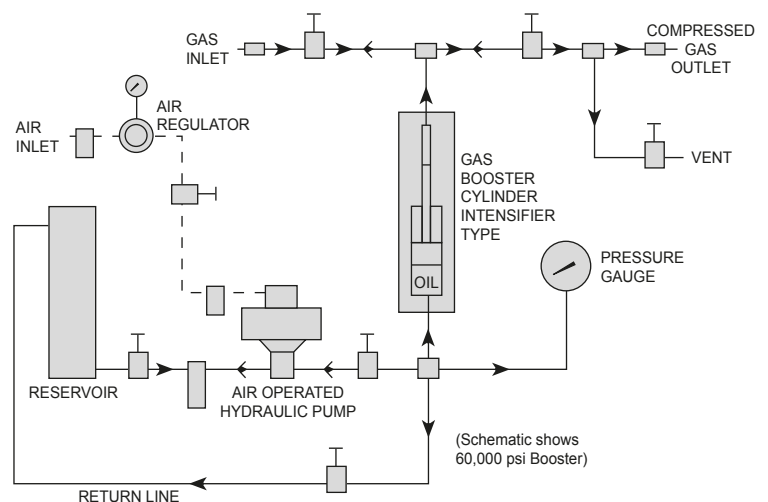

Model GB-30

30,000 psi

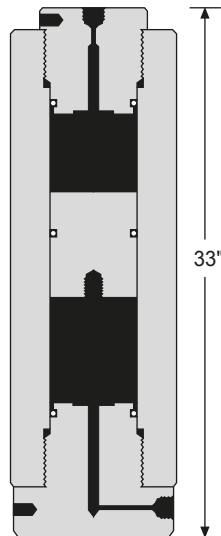

The Model GB-30 Gas Booster is rated for use up to 30,000 psi and has a one-to-one ratio. Displacement per stroke is 112 cubic inches (1835 ml).

Material of construction is 17-4PH stainless steel for the body and covers. The piston is supplied in brass with other materials available as an option. Standard O-ring material for the covers and piston is BUNA-N (nitrile).

Standard connections supplied are for 1/4" O.D. High Pressure tubing (HF4 connection) at each end.

The Model GB-30 can be supplied as a separate unit or with the complete system (Model GBS-30) shown on page 11.6.

The Model GB-30 should not be used with hydrogen or oxygen.

Model GB-60

60,000 psi

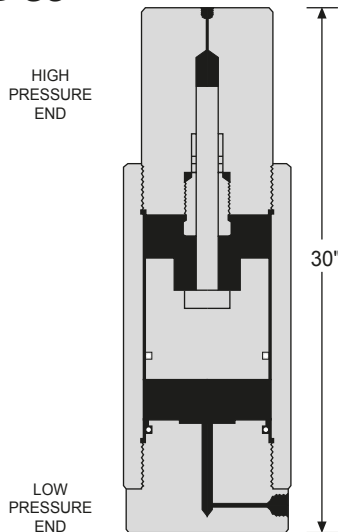

The Model GB-60 Gas Booster is rated for use up to 60,000 psi and has a thirty-to-one (30-1) ratio. Thus, 60,000 psi can be obtained at the high pressure end using only 2,000 psi inlet pressure. Displacement per stroke is 4.7 cubic inches (77 ml).

Material of construction is Type 4340 alloy steel (or equivalent) properly heat treated for use at high pressure. Other internal materials include 17-4PH stainless steel and aluminum bronze. Seals include BUNA-N (nitrile) O-rings and a Parker Poly Pak®.

Standard connections supplied are for 1/4" O.D. High Pressure tubing (HF4 on the high pressure end and AF4 on the low pressure end).

The Model GB-60 can be supplied as a separate unit or with the complete system (Model GBS-60) shown on page 11.6.

The Model GB-60 should not be used with hydrogen or oxygen.

Piston travel - 6"

Special Gas Boosters and Intensifiers

High Pressure Equipment Company has designed and supplied numerous gas boosters and intensifiers to meet the customer's special requirements. A price quotation can be made by advising us of the requirements including: media (gas or liquid) to be pressurized, maximum outlet pressure required, available inlet pressure and required displacement per stroke.



High Pressure Equipment

High Pressure Generators

The HiP High Pressure Generator is a manually operated piston screw pump. It is designed for any application where a liquid* is to be compressed within a small volume to develop pressure.

Pressure Ranges:

0-5,000 psi • 0-10,000 psi • 0-15,000 psi • 0-30,000 psi • 0-60,000 psi • 0-75,000 psi • 0-100,000 psi

All wetted parts are of 316 stainless steel and 17-4PH stainless steel. Parker Poly Pak® is standard.

The High Pressure Generator is easily mounted to a work bench and maximum pressures may be obtained with a minimum amount of effort by the operator. The standard connection is a High Pressure coned-and-threaded (HF4) opening for $\frac{1}{4}$ " O.D. tubing up to 60,000 psi and XF4 connections for pressures above 60,000 psi. Adapters are available with optional Teflon packing at no additional cost for other type connections including pipe.

Typical Applications:

- Testing of instruments, gauges, component parts
- Pressure measurement studies
- Injection of liquid catalysts
- Pressurizing chemicals
- A convenient source of high pressure in the laboratory

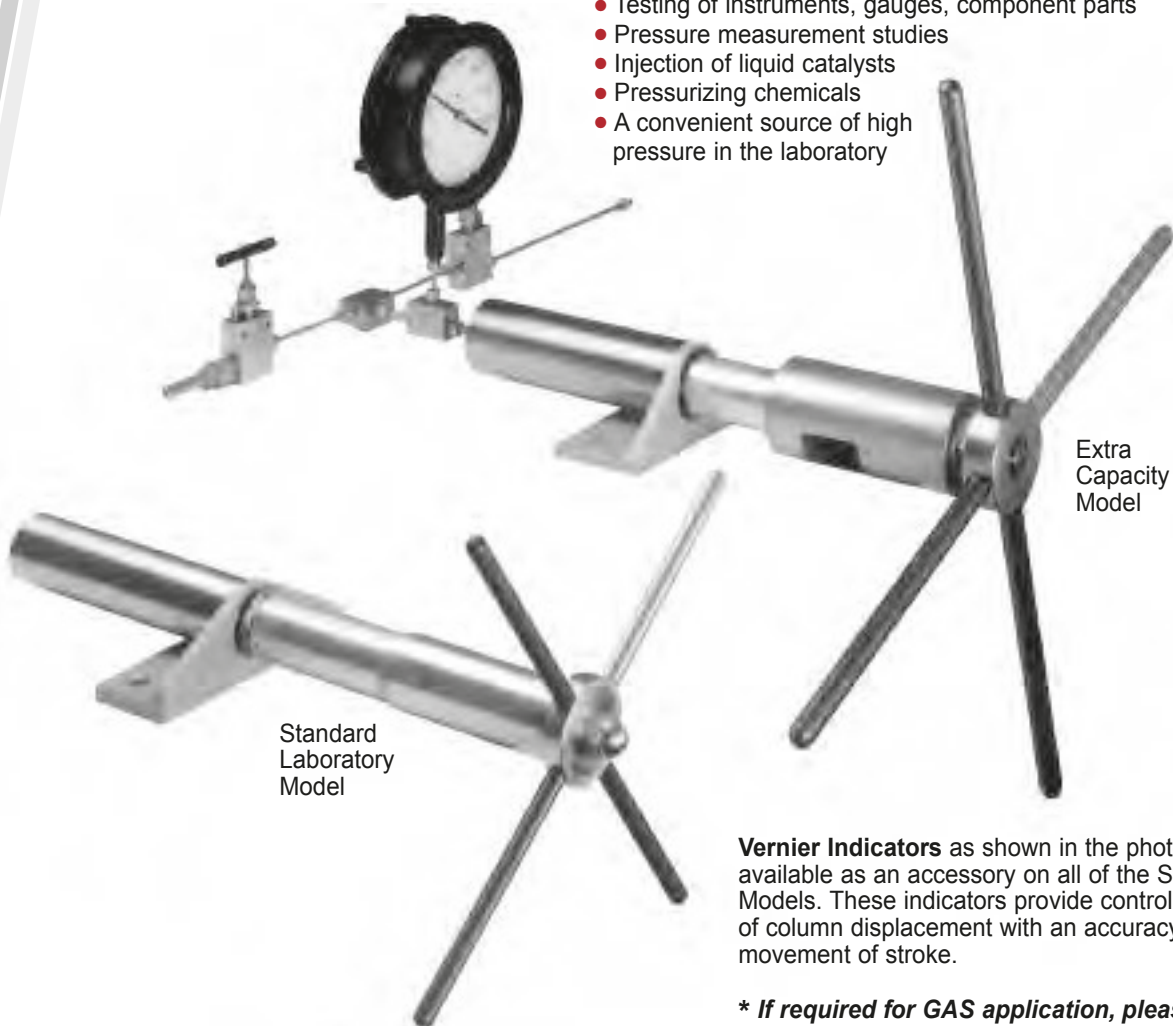

Standard
Laboratory
Model

Extra
Capacity
Model

Vernier Indicators as shown in the photo at left are available as an accessory on all of the Standard Laboratory Models. These indicators provide controlled measurement of column displacement with an accuracy of ± 0.003 " movement of stroke.

** If required for GAS application, please consult factory.*

High Pressure Generators

The schematic illustrates a very basic layout for using a Pressure Generator. A reservoir (R) is shown connected by means of valves and fittings to a component (C) that is to be pressurized. A gauge has been included for determining pressure.

With valve "B" closed and valve "A" open, the handle of the Pressure Generator is rotated counter-clockwise to draw fluid from the reservoir into the cylinder body of the Pressure Generator. Valve "A" is then closed and valve "B" is opened. By rotating the Pressure Generator handle clockwise, the piston will now compress the fluid to develop pressure in the component that is to be pressurized.

If sufficient pressure is not reached in one stroke, the system can be "recycled." Valve "B" can be closed in order to maintain pressure in the components. Valve "A" is then opened, and fluid is again drawn into the Pressure Generator from the reservoir. Closing Valve "A" and opening Valve "B" will now allow the Pressure Generator to be operated to develop increased pressure in the component.

Pressure in the component can be vented by opening both valves.

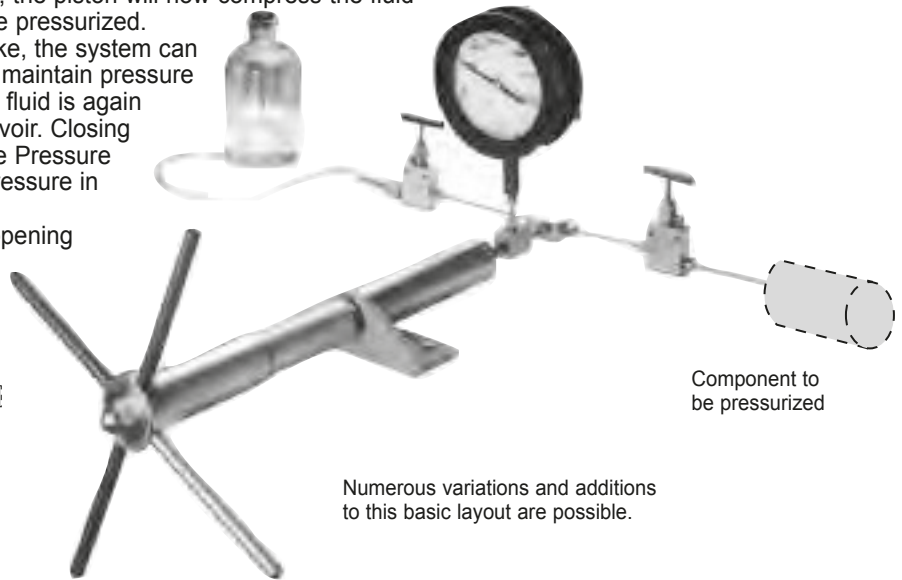
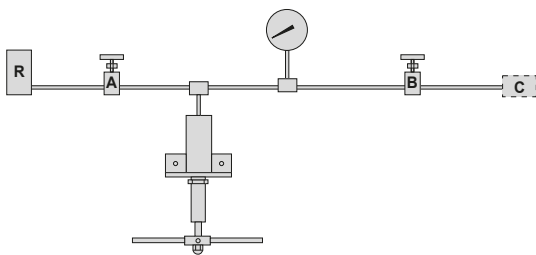

Numerous variations and additions to this basic layout are possible.

Standard Laboratory Models

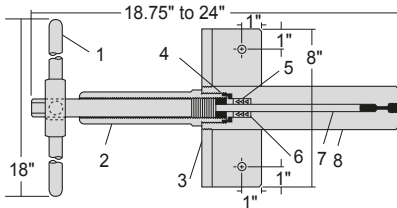

1. Handle
2. Gland Nut
3. Mounting Bracket
4. Top Packing Washer
5. Packing
- * 6. Bottom Packing Washer
7. Shaft
8. Body

| Model | Pressure Rating psi | Capacity per Stroke | Shaft Diameter |
|---------|---------------------|---------------------|----------------|
| 87-6-5 | 5,000 | 60 mL | 7/8" |
| 62-6-10 | 10,000 | 30 mL | 5/8" |
| 50-6-15 | 15,000 | 20 mL | 1/2" |
| 37-6-30 | 30,000 | 11 mL | 3/8" |

Length of stroke: 6 inches. 14 revolutions of handle produces one inch travel of shaft.

* Use item six only with optional Chevron Teflon packing.

Extra Capacity Models

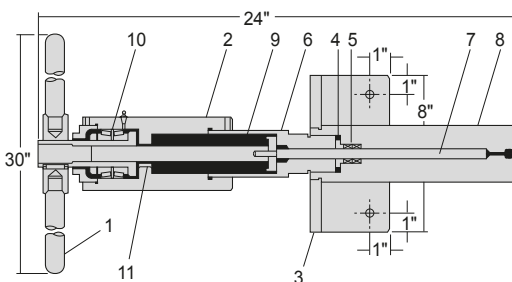

1. Handle
2. Housing
3. Mounting Bracket
4. Packing Washer
5. Packing
6. Extension Gland
7. Shaft
8. Body
9. Stem Screw with Keyway
10. Bearing Assembly
11. Key

| Model | Pressure Rating psi | Capacity per Stroke | Shaft Diameter |
|-------------|---------------------|---------------------|----------------|
| 112-5.75-5 | 5,000 | 93 mL | 1 1/8" |
| 81-5.75-10 | 10,000 | 48 mL | 13/16" |
| 68-5.75-15 | 15,000 | 35 mL | 11/16" |
| 50-5.75-30 | 30,000 | 18 mL | 1/2" |
| 37-5.75-60 | 60,000 | 10 mL | 3/8" |
| 31-5.75-75 | 75,000 | 7 mL | 5/16" |
| 25-5.75-100 | 100,000 | 4.5 mL | 1/4" |

Length of stroke: 5 3/4 inches. 14 revolutions of handle produces one inch travel of shaft.



High Pressure Equipment

Technical Information

Selecting the right product to plumb your pressure system or conduct your research project is a critical decision. In this section, High Pressure Equipment Company provides a variety of technical information to assist you in this selection process. We have included a number of English to Metric conversion charts, flow coefficient formulas and valve ratings, reactor pressure ratings, and recommended torque values for our air operated valves and tubing connections.

As you work with this data, it is important to consider that it is general in nature and may vary depending on the actual parameters of your application. If you have any questions concerning this information or would like assistance in selecting an HiP product, our engineering staff is available and ready to help.



Index

Page

| | |
|--------------------------------------------------------------------------------------------|-----------|
| Conversion Tables | 12.2-12.3 |
| Packing Options | 12.4-12.5 |
| Minimum Safety Hold Down Nut Torque | 12.6 |
| Minimum Bend Radius For High Pressure Tubing | 12.6 |
| Flow Coefficients | 12.6 |
| Pressure Ratings of Bolted Closure Reactors | 12.7 |
| Recommended Torque | 12.7 |
| Pressure Ratings For: • Equipment in Various Common Materials | 12.8 |
| • Tubing in Various Materials | 12.8 |
| Maximum Recommended Volumetric Flow Rate | 12.8 |
| Pressure Rating Reduction 316-304 SS Components at Elevated Temperatures | 12.9 |
| Graphs • Temperature Rating For Taper Seal Valves & Fittings | 12.10 |
| • Pressure Rating Reduction 316-304 SS Components at Elevated Temperatures | 12.10 |
| • Micrometering Valve Flow | 12.10 |



High Pressure Equipment

Pressure

| | Pa | kPa | psi | kg/cm ² | bar | atm | MPa |
|--------------------|-------------------------|-------|--------------------------|--------------------------|----------------------|--------------------------|----------------------|
| Pa | 1 | 0.001 | 1.450 x 10 ⁻⁴ | 1.020 x 10 ⁻⁵ | 1 x 10 ⁻⁵ | 9.869 x 10 ⁻⁶ | 1 x 10 ⁻⁶ |
| kPa | 1000 | 1 | 0.145 | 0.01 | 0.01 | 0.01 | 0.001 |
| psi | 6.895 x 10 ³ | 6.895 | 1 | 0.07 | 0.069 | 0.068 | 0.007 |
| kg/cm ² | 9.807 x 10 ⁴ | 98.07 | 14.22 | 1 | 0.981 | 0.968 | 0.098 |
| bar | 1 x 10 ⁵ | 100 | 14.50 | 1.02 | 1 | 0.987 | 0.1 |
| atm | 101.3 x 10 ⁵ | 101.3 | 14.7 | 1.033 | 1.013 | 1 | 0.101 |
| MPa | 1 x 10 ⁶ | 1000 | 145 | 10.2 | 10 | 9.869 | 1 |

Flow

| | mL/min | in ³ /min | ft ³ /hr | liter/min | gal/min |
|----------------------|--------|----------------------|---------------------|-----------|--------------------------|
| mL/min | 1 | 0.061 | 0.002 | 0.001 | 6.242 x 10 ⁻⁴ |
| in ³ /min | 16.39 | 1 | 0.035 | 0.016 | 0.004 |
| ft ³ /hr | 472 | 28.8 | 1 | 0.472 | 0.125 |
| liter/min | 1000 | 61.02 | 2.119 | 1 | 0.264 |
| gal/min | 3785 | 231 | 8.021 | 3.785 | 1 |

Weight/Mass

| | gram | oz | lb | kg |
|------|-------|-------|-------|-------|
| gram | 1 | 0.035 | 0.002 | 0.001 |
| oz | 28.35 | 1 | 0.063 | 0.028 |
| lb | 453.6 | 16 | 1 | 0.454 |
| kg | 1000 | 35.28 | 2.205 | 1 |

Volume

| | mL | in ³ | liter | gal | ft ³ | m ³ |
|-----------------|-------------------------|-------------------------|-------|--------------------------|--------------------------|--------------------------|
| mL | 1 | 0.061 | 0.001 | 2.642 x 10 ⁻⁴ | 3.531 x 10 ⁻⁵ | 1 x 10 ⁻⁶ |
| in ³ | 16.39 | 1 | 0.016 | 0.004 | 5.787 x 10 ⁻⁴ | 1.639 x 10 ⁻⁵ |
| liter | 1000 | 61.02 | 1 | 0.264 | 0.035 | 0.001 |
| gal | 3.785 x 10 ³ | 231 | 3.785 | 1 | 0.134 | 0.004 |
| ft ³ | 2.832 x 10 ⁴ | 1.728 x 10 ³ | 28.32 | 7.481 | 1 | 0.028 |
| m ³ | 1 x 10 ⁶ | 6.102 x 10 ⁴ | 1000 | 264.2 | 35.32 | 1 |

Linear

| | micron | millimeter | centimeter | inch | foot | meter |
|------------|-------------------------|------------|----------------------|--------------------------|--------------------------|-----------------------|
| micron | 1 | 0.001 | 1 x 10 ⁻⁴ | 3.937 x 10 ⁻⁵ | 3.281 x 10 ⁻⁶ | 1 x 10 ⁻¹⁰ |
| millimeter | 1000 | 1 | 0.1 | 0.03937 | 0.003 | 0.001 |
| centimeter | 1 x 10 ⁻⁴ | 10 | 1 | 0.394 | 0.033 | 0.01 |
| inch | 2.540 x 10 ⁴ | 25.4 | 2.54 | 1 | 0.083 | 0.025 |
| foot | 3.048 x 10 ⁵ | 304.8 | 30.48 | 12 | 1 | 0.305 |
| meter | 1 x 10 ⁶ | 1000 | 100 | 39.37 | 3.281 | 1 |

Temperature

Fahrenheit to Celsius

| °F | °C | °F | °C | °F | °C |
|------|------|-----|-----|------|-----|
| -440 | -262 | 260 | 127 | 820 | 438 |
| -420 | -251 | 270 | 132 | 840 | 449 |
| -400 | -240 | 280 | 138 | 860 | 460 |
| -380 | -229 | 290 | 143 | 880 | 471 |
| -360 | -218 | 300 | 149 | 900 | 482 |
| -340 | -207 | 310 | 154 | 920 | 493 |
| -320 | -196 | 320 | 160 | 940 | 504 |
| -300 | -184 | 330 | 166 | 960 | 516 |
| -280 | -173 | 340 | 171 | 980 | 527 |
| -260 | -162 | 350 | 177 | 1000 | 538 |
| -240 | -151 | 360 | 182 | 1020 | 549 |
| -220 | -140 | 370 | 188 | 1040 | 560 |
| -200 | -129 | 380 | 193 | 1060 | 571 |
| -180 | -118 | 390 | 199 | 1080 | 582 |
| -160 | -107 | 400 | 204 | 1100 | 593 |
| -140 | -96 | 410 | 210 | 1120 | 604 |
| -120 | -84 | 420 | 216 | 1140 | 616 |
| -100 | -73 | 430 | 221 | 1160 | 627 |
| -80 | -62 | 440 | 227 | 1180 | 638 |
| -60 | -51 | 450 | 232 | 1200 | 649 |
| -40 | -40 | 460 | 238 | 1220 | 660 |
| -30 | -34 | 470 | 243 | 1240 | 671 |
| -20 | -29 | 480 | 249 | 1260 | 682 |
| -10 | -23 | 490 | 254 | 1280 | 693 |
| 0 | -18 | 500 | 260 | 1300 | 704 |
| 10 | -12 | 510 | 266 | 1320 | 716 |
| 20 | -7 | 520 | 271 | 1340 | 727 |
| 30 | -1 | 530 | 277 | 1360 | 738 |
| 40 | 4 | 540 | 282 | 1380 | 749 |
| 50 | 10 | 550 | 288 | 1400 | 760 |
| 60 | 16 | 560 | 293 | 1420 | 771 |
| 70 | 21 | 570 | 299 | 1440 | 782 |
| 80 | 27 | 580 | 304 | 1460 | 793 |
| 90 | 32 | 590 | 310 | 1480 | 804 |
| 100 | 38 | 600 | 316 | 1500 | 816 |
| 110 | 43 | 610 | 321 | 1520 | 827 |
| 120 | 49 | 620 | 327 | 1540 | 838 |
| 130 | 54 | 630 | 332 | 1560 | 849 |
| 140 | 60 | 640 | 338 | 1580 | 860 |
| 150 | 66 | 650 | 343 | 1600 | 871 |
| 160 | 71 | 660 | 349 | 1620 | 882 |
| 170 | 77 | 670 | 354 | 1640 | 893 |
| 180 | 82 | 680 | 360 | 1660 | 904 |
| 190 | 88 | 690 | 366 | 1680 | 916 |
| 200 | 93 | 700 | 371 | 1700 | 927 |
| 210 | 99 | 720 | 382 | 1720 | 938 |
| 220 | 104 | 740 | 393 | 1740 | 949 |
| 230 | 110 | 760 | 404 | 1760 | 960 |
| 240 | 116 | 780 | 416 | 1780 | 971 |
| 250 | 121 | 800 | 427 | 1800 | 982 |

Celsius to Fahrenheit

| °C | °F | °C | °F | °C | °F |
|------|------|-----|------|------|------|
| -270 | -454 | 230 | 446 | 730 | 1346 |
| -260 | -436 | 240 | 464 | 740 | 1364 |
| -250 | -418 | 250 | 482 | 750 | 1382 |
| -240 | -400 | 260 | 500 | 760 | 1400 |
| -230 | -382 | 270 | 518 | 770 | 1418 |
| -220 | -364 | 280 | 536 | 780 | 1436 |
| -210 | -346 | 290 | 554 | 790 | 1454 |
| -200 | -328 | 300 | 572 | 800 | 1472 |
| -190 | -310 | 310 | 590 | 810 | 1490 |
| -180 | -292 | 320 | 608 | 820 | 1508 |
| -170 | -274 | 330 | 626 | 830 | 1526 |
| -160 | -256 | 340 | 644 | 840 | 1544 |
| -150 | -238 | 350 | 662 | 850 | 1562 |
| -140 | -220 | 360 | 680 | 860 | 1580 |
| -130 | -202 | 370 | 698 | 870 | 1598 |
| -120 | -184 | 380 | 716 | 880 | 1616 |
| -110 | -166 | 390 | 734 | 890 | 1634 |
| -100 | -148 | 400 | 752 | 900 | 1652 |
| -90 | -130 | 410 | 770 | 910 | 1670 |
| -80 | -112 | 420 | 788 | 920 | 1688 |
| -70 | -94 | 430 | 806 | 930 | 1706 |
| -60 | -76 | 440 | 824 | 940 | 1724 |
| -50 | -58 | 450 | 842 | 950 | 1742 |
| -40 | -40 | 460 | 860 | 960 | 1760 |
| -30 | -22 | 470 | 878 | 970 | 1778 |
| -20 | -4 | 480 | 896 | 980 | 1796 |
| -10 | 14 | 490 | 914 | 990 | 1814 |
| 0 | 32 | 500 | 932 | 1000 | 1832 |
| 10 | 50 | 510 | 950 | | |
| 20 | 68 | 520 | 968 | | |
| 30 | 86 | 530 | 986 | | |
| 40 | 104 | 540 | 1004 | | |
| 50 | 122 | 550 | 1022 | | |
| 60 | 140 | 560 | 1040 | | |
| 70 | 158 | 570 | 1058 | | |
| 80 | 176 | 580 | 1076 | | |
| 90 | 194 | 590 | 1094 | | |
| 100 | 212 | 600 | 1112 | | |
| 110 | 230 | 610 | 1130 | | |
| 120 | 248 | 620 | 1148 | | |
| 130 | 266 | 630 | 1166 | | |
| 140 | 284 | 640 | 1184 | | |
| 150 | 302 | 650 | 1202 | | |
| 160 | 320 | 660 | 1220 | | |
| 170 | 338 | 670 | 1238 | | |
| 180 | 356 | 680 | 1256 | | |
| 190 | 374 | 690 | 1274 | | |
| 200 | 392 | 700 | 1292 | | |
| 210 | 410 | 710 | 1310 | | |
| 220 | 428 | 720 | 1328 | | |

$$\begin{aligned} \text{°F} &= \frac{9}{5} \text{°C} + 32 \\ \text{°C} &= \frac{5}{9} (\text{°F} - 32) \\ \text{°R} &= \text{°F} + 459.67 \\ \text{K} &= \text{°C} + 273.15 \end{aligned}$$



High Pressure Equipment

Packing Options

NPT Hand Valves

10,000 psi Series

| Material | Part Number | | |
|----------|-----------------|--------|------------|
| | NFA/NFB/ NFC | NFD | NFF - NFH |
| Teflon* | B-181 | B-185 | 208741 Set |
| Grafoil | B-1417 | B-1359 | — |
| Buna-N | B-102 | — | — |
| Viton | B-849 | — | — |
| Silicone | B-147 | — | — |

15,000 psi Series

| Material | Part Number | |
|----------|-------------|------------|
| | NFA NFB | NFC NFD |
| Teflon* | B-1392 Set | 207341 Set |
| Grafoil | B-1391 Set | B-1386 Set |
| Polypak | B-1388 (1) | B-1387 (1) |

Hand Valves

Taper Seal

| Material | Part Number | | |
|----------|-------------|--------|-------------|
| | AF1 | AF2 | AF4/ AF6 |
| Teflon* | B-195 | B-195 | B-181 |
| Grafoil | B-1379 | B-1379 | B-1417 |
| Buna-N | B-101 | B-101 | B-102 |
| Viton | B-614 | B-614 | B-849 |
| Silicone | B-149 | B-149 | B-147 |

Medium Pressure

| Material | Part Number | | | |
|----------|-------------|------------|-------------------------|-------------------------|
| | LF4/ LF6 | LF9 | LF12 | LF16 |
| Teflon* | B-1392 Set | 207341 Set | 208740 Set | 208741 Set |
| Grafoil | B-1391 Set | B-1386 Set | B-1455 Set ¹ | B-1440 Set ² |
| Polypak | B-1388 (1) | B-1387 (1) | B-1431 (1) ¹ | B-1742 (1) ² |

¹ LF12 Series: When Grafoil and Polypak are used, top washer 208937 and bottom washer 208939 must be installed

² LF16 Series: When Grafoil and Polypak are used, top washer 209308 and bottom washer 209309 must be installed

High Pressure 30,000 psi

| Material | Part Number | | |
|----------|-------------|----------------|-------------------------|
| | HF2 | HF4/HF6 HF9 | HF16 |
| Teflon* | B-195 | B-181 | 208741 Set |
| Grafoil | B-1379 | B-1417 | B-1455 Set ³ |
| Buna-N | B-101 | B-102 | — |
| Viton | B-614 | B-849 | — |
| Silicone | B-149 | B-147 | — |
| Polypak | — | — | B-1431 (1) ³ |

³ HF16 Series: When Grafoil and Polypak are used, top washer 210779 and bottom washer 208939 must be installed

High Pressure 60,000 psi

| Material | Part Number |
|----------------|---------------------|
| | HF2/HF4/ HF6/HF9 |
| Teflon/Nylon** | 209689 |
| Grafoil | B-1379 |
| TFE/Viton | 212401 |

Ultra High Pressure

| Material | Part Number |
|----------------|-------------|
| | XF4/ XF6 |
| Teflon/Nylon** | 208691 |

* Teflon packing supplied as standard

** Teflon/Nylon packing supplied as standard

Note: For pricing see Spare Parts list in Price List

Packing Options

NPT Air Operated Valves

HIPCO 10,000 psi Series

| Material | Part Number |
|----------|-------------|
| | NFA NFB |
| Teflon* | B-181 |
| Grafoil | B-1417 |
| Buna-N | B-102 |
| Viton | B-849 |
| Silicone | B-147 |

HIPCO 15,000 psi Series

| Material | Part Number | |
|----------|-------------|------------|
| | NFA NFB | NFC NFD |
| Teflon* | B-1392 Set | 207341 Set |
| Grafoil | B-1391 Set | B-1386 Set |
| Polypak | B-1388 (1) | B-1387 (1) |

HIPPO 15,000 psi Series

| Material | Part Number | |
|----------|-------------|------------|
| | NFA NFB | NFC NFD |
| Teflon* | B-1392 Set | 207341 Set |
| Grafoil | B-1391 Set | B-1386 Set |
| Polypak | B-1388 (1) | B-1387 (1) |

Air Operated Valves

HIPCO Taper Seal

| Material | Part Number |
|----------|-------------|
| | AF4 AF6 |
| Teflon* | B-181 |
| Buna-N | B-102 |
| Viton | B-849 |
| Silicone | B-147 |

HIPPO Taper Seal

| Material | Part Number |
|----------|-------------|
| | AF4 AF6 |
| Teflon* | B-181 |
| Buna-N | B-102 |
| Viton | B-849 |
| Silicone | B-147 |

Mini HIPPO

| Material | Part Number | | |
|----------|-------------|-------------|-----------------|
| | AF2 | AF4/ AF6 | HF4/HF6/ HF9 |
| Teflon* | B-195 | B-181 | B-181 |
| Buna-N | B-101 | B-102 | B-102 |
| Viton | B-614 | B-849 | B-849 |
| Silicone | B-149 | B-147 | B-147 |

HIPCO Medium Pressure

| Material | Part Number | |
|----------|-------------|------------|
| | LF4/ LF6 | LF9 |
| Teflon* | B-1392 Set | 207341 Set |
| Grafoil | B-1391 Set | B-1386 Set |
| Polypak | B-1388 (1) | B-1387 (1) |

HIPPO Medium Pressure

| Material | Part Number | |
|----------|-------------|------------|
| | LF4/ LF6 | LF9 |
| Teflon* | B-1392 Set | 207341 Set |
| Grafoil | B-1391 Set | B-1386 Set |
| Polypak | B-1388 (1) | B-1387 (1) |

HIPCO High Pressure 30,000 psi

| Material | Part Number |
|------------|-----------------|
| | HF4/HF6/ HF9 |
| Teflon* | B-181 |
| Grafoil | B-1417 |
| TFE/Buna-N | 209276 |

HIPPO High Pressure 30,000 psi

| Material | Part Number |
|------------|-----------------|
| | HF4/HF6/ HF9 |
| Teflon* | B-181 |
| Grafoil | B-1417 |
| TFE/Buna-N | 209276 |

HIPCO High Pressure 60,000 psi

| Material | Part Number |
|----------------|---------------------|
| | HF2/HF4/ HF6/HF9 |
| Teflon/Nylon** | 209689 |
| Grafoil | B-1379 |
| TFE/Viton | 212401 |

HIPPO High Pressure 60,000 psi

| Material | Part Number |
|----------------|---------------------|
| | HF2/HF4/ HF6/HF9 |
| Teflon/Nylon** | 209689 |
| Grafoil | B-1379 |
| TFE/Viton | 212401 |

Temperature Ratings for Packing Options

| Material | Maximum Temperature Rating |
|-----------|----------------------------|
| Buna-N | 200°F |
| Grafoil | 800°F |
| PolyPak | 200°F |
| Silicone | 400°F |
| Teflon | 450°F |
| TFE/Nylon | 180°F |
| TFE/Viton | 400°F |
| Viton | 400°F |

* Teflon packing supplied as standard

** Teflon/Nylon packing supplied as standard

Note: For pricing see Spare Parts list in Price List



High Pressure Equipment

Minimum Safety Head Hold Down Nut Torque

| Pressure psi | Torque foot pounds |
|-----------------|-----------------------|
| 10,000 | 40 |
| 15,000 | 45 |
| 20,000 | 50 |
| 25,000 | 55 |
| 30,000 | 60 |
| 35,000 | 65 |
| 40,000 | 70 |
| 45,000 | 75 |
| 50,000 | 80 |
| 55,000 | 85 |
| 60,000 | 90 |

Minimum Recommended Bend Radius For High Pressure Tubing

| Tube Size O.D. x I.D. | Minimum Bend Radius |
|------------------------------------------------------------------|------------------------|
| 0.250 x 0.062 0.250 x 0.083 0.250 x 0.109 0.250 x 0.125 | 1.25 in |
| 0.375 x 0.062 0.375 x 0.125 0.375 x 0.203 0.375 x 0.250 | 1.75 in |
| 0.562 x 0.188 0.562 x 0.250 0.562 x 0.312 | 2.62 in |
| 0.750 x 0.438 0.750 x 0.516 | 3.50 in |
| 1" x 0.438 1" x 0.562 1" x 0.688 | 4.62 in |

Flow Coefficients

The flow coefficient C_v is a valve sizing designation commonly determined by laboratory test. It corresponds to the flow rate of water through a valve in US gallons per minute at 60°F with a differential pressure drop of one psi.

Flow coefficients of various HiP valves

| Valve | C_v | Valve | C_v |
|-----------|-------|-----------|-------|
| 15-11AF1 | 0.03 | 40-11HF9 | 0.15 |
| 15-11AF2 | 0.05 | 60-11HF2 | 0.04 |
| 10-11AF4 | 0.15 | 60-11HF4 | 0.04 |
| 10-11AF6 | 0.15 | 60-11HF6 | 0.04 |
| 20-11LF4 | 0.17 | 60-11HF9 | 0.04 |
| 20-11LF6 | 0.45 | 100-11XF4 | 0.04 |
| 20-11LF9 | 1.12 | 150-11XF6 | 0.04 |
| 10-11LF12 | 3.65 | 10-11NFA | 0.15 |
| 20-11LF12 | 2.29 | 10-11NFB | 0.15 |
| 10-11LF16 | 5.91 | 10-11NFC | 0.15 |
| 20-11LF16 | 3.86 | 10-11NFD | 1.12 |
| 30-11HF2 | 0.04 | 15F-11NFA | 0.45 |
| 30-11HF4 | 0.09 | 15F-11NFB | 0.45 |
| 30-11HF6 | 0.15 | 15F-11NFC | 1.12 |
| 30-11HF9 | 0.15 | 15F-11NFD | 1.12 |
| 30-11HF16 | 2.29 | 10F-11NFF | 5.91 |
| | | 10F-11NFH | 5.91 |

With the C_v coefficient known, the following values can be calculated:

- Liquid flow capacity in US gallons per minute

$$Q_l = C_v \sqrt{\frac{\Delta P}{G}}$$

- Pressure drop across valve (liquid flow)

$$\Delta P = G \cdot \frac{Q_l^2}{C_v^2}$$

- Gas flow capacity in standard cubic feet per hour (SCFH)

$$Q_g = 1360 \cdot C_v \sqrt{\frac{P \cdot \Delta P}{T \cdot G \cdot Z}}$$

- Pressure drop across valve (gas flow)

$$\Delta P = \frac{T \cdot G \cdot Z}{P} \cdot \left(\frac{Q_g}{1360 \cdot C_v} \right)^2$$

Where:

C_v = Valve flow coefficient

G = Specific gravity of fluid

ΔP = Differential pressure drop across valve (psi)

P = System pressure at valve inlet (psia)

Q_l = Liquid flow in US gallons per minute (GPM)

Q_g = Gas flow in standard cubic feet per hour (SCFH)

T = System temperature (°R)

Z = Gas compressibility factor at operating conditions

Pressure Ratings

Bolted Closure Reactors (psi) at Elevated Temperatures

| Temperature °F (°C) | BC-1 | BC-2, BC-3, BC-5 | BC-4, BC-6 |
|---------------------|------|------------------|------------|
| 100 (38) | 5600 | 5250 | 3150 |
| 200 (93) | 5600 | 5250 | 3150 |
| 300 (149) | 5500 | 5100 | 3100 |
| 400 (204) | 5400 | 5050 | 3050 |
| 500 (260) | 5350 | 5050 | 3050 |
| 600 (316) | 5100 | 5050 | 3050 |
| 650 (343) | 5000 | 5000 | 3000 |

| Temperature °F (°C) | BC-1 | BC-2, BC-3, BC-5 | BC-4, BC-6 |
|---------------------|------|------------------|------------|
| 700 (371) | 4900 | 4900 | 2950 |
| 750 (399) | 4800 | 4800 | 2850 |
| 800 (427) | 4200 | 4200 | 2500 |
| 850 (454) | 3400 | 3400 | 2050 |
| 900 (482) | 2500 | 2500 | 1500 |
| 950 (510) | 1700 | 1700 | 1000 |
| 1000 (538) | 900 | 900 | 550 |

Recommended Torque

Tubing Connections

| Connection | Recommended Torque |
|------------|---------------------------------------------------------------------------------------------|
| AF1 | 55 inch pounds |
| AF2 | 10 foot pounds initial to compress sleeve onto tube 25 foot pounds to tighten connection |
| AF4 | 30 foot pounds initial to compress sleeve onto tube 50 foot pounds to tighten connection |
| AF6 | 40 foot pounds initial to compress sleeve onto tube 60 foot pounds to tighten connection |
| LF4 | 20 foot pounds |
| LF6 | 30 foot pounds |
| LF9 | 50 foot pounds |
| LF12 | 90 foot pounds |
| LF16 | 125 foot pounds |
| HF2 | 75 inch pounds |
| HF4 | 25 foot pounds |
| HF6 | 50 foot pounds |
| HF9 | 110 foot pounds |
| HF16 | 150 foot pounds |
| XF4 | 45 foot pounds |
| XF6 | 70 foot pounds |

Minimum Packing Gland Torque for Valves

| Valve Series | Pressure Rating | Packing Gland Torque |
|----------------------------------------------|--------------------------|----------------------|
| 15-**AF1 15-**AF2 | 15,000 psi | 15 foot pounds |
| 10-**AF4 10-**AF6 | 10,000 psi | 30 foot pounds |
| 10-**NFA 10-**NFB 10-**NFC | 10,000 psi | 35 foot pounds |
| 10-**NFD | 10,000 psi | 50 foot pounds |
| 20-**LF4 20-**LF6 | 20,000 psi 20,000 psi | 35 foot pounds |
| 20-**LF9 | 20,000 psi | 70 foot pounds |
| 30-**HF2 30-**HF4 30-**HF6 30-**HF9 | 30,000 psi | 30 foot pounds |
| 60-**HF2 60-**HF4 60-**HF6 60-**HF9 | 60,000 psi | 40 foot pounds |
| 100-**XF4 | 100,000 psi | 60 foot pounds |
| 150-**XF6 | 150,000 psi | 90 foot pounds |



High Pressure Equipment

Pressure Ratings

Equipment in Various Common Materials

| Material | 316SS CW (std rating) | 316 SS Annealed | 316L SS Annealed | Duplex 2205 | Duplex 2507 | Hast C276 Annealed |
|-------------------------------------|-----------------------|-----------------|------------------|-------------|-------------|--------------------|
| Pressure Rating at Room Temperature | 60,000 psi | 30,000 psi | 26,250 psi | 54,000 psi | 60,000 psi | 41,000 psi |
| | 30,000 psi | 20,000 psi | 13,000 psi | 27,000 psi | 30,000 psi | 20,500 psi |
| | 20,000 psi | 10,000 psi | 8,750 psi | 18,000 psi | 20,000 psi | 13,500 psi |
| | 15,000 psi | 12,000 psi | 10,000 psi | 15,000 psi | 15,000 psi | 15,000 psi |
| | 10,000 psi | 10,000 psi | 10,000 psi | 10,000 psi | 10,000 psi | 10,000 psi |

| Material | Inconel 600 Annealed | Inconel 625 sol Annealed | Inconel 718 | Monel Annealed | Titanium Grade 2 | Titanium Grade 5 (6A14V) | 254 SMO |
|-------------------------------------|----------------------|--------------------------|-------------|----------------|------------------|--------------------------|------------|
| Pressure Rating at Room Temperature | 34,500 psi | 40,500 psi | 60,000 psi | 28,250 psi | 30,000 psi | 60,000 psi | 43,500 psi |
| | 17,250 psi | 20,250 psi | 30,000 psi | 14,000 psi | 15,000 psi | 30,000 psi | 21,750 psi |
| | 11,500 psi | 13,500 psi | 20,000 psi | 9,250 psi | 10,000 psi | 20,000 psi | 14,500 psi |
| | 15,000 psi | 15,000 psi | 15,000 psi | 11,000 psi | 10,000 psi | 15,000 psi | 15,000 psi |
| | 10,000 psi | 10,000 psi | 10,000 psi | 10,000 psi | 10,000 psi | 10,000 psi | 10,000 psi |

Tubing in Various Materials*

| | Tubing Size OD x ID (inches) | Material vs Pressure Rating | | | | | |
|-----------------|------------------------------|-----------------------------|----------------|-------------|------------|------------|---------------|
| | | 316 CW | Hastelloy C276 | Inconel 600 | Monel 400 | Nickel 200 | Titanium Gr 2 |
| Low Pressure | 1/8 x 0.060 | 15,000 psi | 10,400 psi | 8,750 psi | 7,150 psi | 4,125 psi | 7,675 psi |
| | 1/4 x 0.125 | 10,000 psi | 6,750 psi | 5,650 psi | 4,625 psi | 2,675 psi | 4,975 psi |
| | 3/8 x 0.250 | 10,000 psi | 6,750 psi | 5,650 psi | 4,625 psi | 2,675 psi | 4,975 psi |
| Medium Pressure | 1/4 x 0.109 | 20,000 psi | 13,500 psi | 11,325 psi | 9,275 psi | 5,350 psi | 9,950 psi |
| | 3/8 x 0.203 | 20,000 psi | 13,500 psi | 11,325 psi | 9,275 psi | 5,350 psi | 9,950 psi |
| | 9/16 x 0.359 | 10,000 psi | 6,750 psi | 5,650 psi | 4,625 psi | 2,675 psi | 4,975 psi |
| | 9/16 x 0.312 | 20,000 psi | 13,500 psi | 11,325 psi | 9,275 psi | 5,350 psi | 9,950 psi |
| | 3/4 x 0.516 | 10,000 psi | 6,750 psi | 5,650 psi | 4,625 psi | 2,675 psi | 4,975 psi |
| | 3/4 x 0.438 | 20,000 psi | 13,500 psi | 11,325 psi | 9,275 psi | 5,350 psi | 9,950 psi |
| | 1 x 0.688 | 10,000 psi | 6,750 psi | 5,650 psi | 4,625 psi | 2,675 psi | 4,975 psi |
| 1 x 0.562 | 20,000 psi | 13,500 psi | 11,325 psi | 9,275 psi | 5,350 psi | 9,950 psi | |
| High Pressure | 1/8 x 0.020 | 60,000 psi | 41,700 psi | 35,000 psi | 28,650 psi | 16,575 psi | 30,700 psi |
| | 1/8 x 0.040 | 30,000 psi | 20,850 psi | 17,500 psi | 14,325 psi | 8,275 psi | 15,350 psi |
| | 1/4 x 0.083 | 60,000 psi | 35,975 psi | 30,175 psi | 24,725 psi | 14,300 psi | 26,475 psi |
| | 3/8 x 0.125 | 60,000 psi | 35,975 psi | 30,175 psi | 24,725 psi | 14,300 psi | 26,475 psi |
| | 9/16 x 0.188 | 60,000 psi | 35,975 psi | 30,175 psi | 24,730 psi | 14,300 psi | 26,475 psi |
| | 9/16 x 0.250 | 40,000 psi | 27,000 psi | 22,675 psi | 18,575 psi | 10,725 psi | 19,900 psi |
| | 1 x 0.437 | 30,000 psi | 20,275 psi | 17,000 psi | 13,925 psi | 8,050 psi | 14,925 psi |

* Not all tubing sizes available in all materials.

Volumetric Flow Rate

Maximum Recommended Volumetric Flow Rate for Water through a Tube

| Orifice Size (inches) | Max Flow (gpm) | Approximate ΔP (psi/ft) |
|-----------------------|----------------|---------------------------------|
| 0.016 | 0.030 | 525 |
| 0.020 | 0.050 | 390 |
| 0.030 | 0.112 | 230 |
| 0.031 | 0.119 | 220 |
| 0.040 | 0.198 | 160 |
| 0.047 | 0.274 | 130 |
| 0.052 | 0.335 | 115 |
| 0.060 | 0.446 | 95 |
| 0.062 | 0.476 | 90 |
| 0.078 | 0.754 | 70 |
| 0.083 | 0.854 | 65 |
| 0.094 | 1.09 | 55 |
| 0.109 | 1.47 | 45 |
| 0.125 | 1.93 | 40 |
| 0.141 | 2.46 | 35 |
| 0.156 | 3.01 | 30 |
| 0.172 | 3.66 | 25 |
| 0.188 | 4.38 | 23 |
| 0.203 | 5.10 | 21 |
| 0.219 | 5.94 | 20 |
| 0.234 | 6.78 | 18 |
| 0.250 | 7.74 | 17 |
| 0.266 | 8.77 | 15 |
| 0.281 | 9.78 | 14 |
| 0.294 | 10.7 | 13 |
| 0.312 | 12.0 | 13 |
| 0.328 | 13.3 | 12 |
| 0.344 | 14.6 | 11 |
| 0.359 | 15.9 | 11 |
| 0.375 | 17.4 | 10 |
| 0.391 | 18.9 | <10 |
| 0.406 | 20.4 | <10 |
| 0.422 | 22.0 | <10 |
| 0.438 | 23.7 | <10 |
| 0.453 | 25.4 | <10 |

| Orifice Size (inches) | Max Flow (gpm) | Approximate ΔP (psi/ft) |
|-----------------------|----------------|---------------------------------|
| 0.469 | 27.2 | <10 |
| 0.484 | 29.0 | <10 |
| 0.500 | 30.9 | <7 |
| 0.516 | 33.0 | <7 |
| 0.531 | 34.9 | <7 |
| 0.547 | 37.0 | <7 |
| 0.562 | 39.1 | <7 |
| 0.578 | 41.4 | <7 |
| 0.594 | 43.7 | <7 |
| 0.609 | 45.9 | <7 |
| 0.625 | 48.4 | <7 |
| 0.641 | 50.9 | <7 |
| 0.656 | 53.3 | <7 |
| 0.672 | 55.9 | <5 |
| 0.688 | 58.6 | <5 |
| 0.703 | 61.2 | <5 |
| 0.719 | 64.0 | <5 |
| 0.734 | 66.7 | <5 |
| 0.750 | 69.7 | <5 |
| 0.766 | 72.7 | <5 |
| 0.781 | 75.6 | <5 |
| 0.797 | 78.7 | <5 |
| 0.812 | 81.7 | <5 |
| 0.828 | 84.9 | <5 |
| 0.844 | 88.3 | <5 |
| 0.859 | 91.4 | <5 |
| 0.875 | 94.9 | <5 |
| 0.891 | 98.4 | <5 |
| 0.906 | 101 | <5 |
| 0.922 | 105 | <5 |
| 0.938 | 109 | <5 |
| 0.953 | 112 | <5 |
| 0.969 | 116 | <5 |
| 0.984 | 120 | <5 |
| 1.000 | 123 | <5 |

Pressure Rating Reduction

316 and 304 SS components at elevated levels.

| Temperature °F (°C) | Percent of Room Temperature Rating |
|---------------------|------------------------------------|
| Up to 100 (38) | 100 |
| 200 (93) | 100 |
| 300 (149) | 100 |
| 400 (204) | 96.5 |
| 500 (260) | 90 |
| 600 (316) | 85 |

| Temperature °F (°C) | Percent of Room Temperature Rating |
|---------------------|------------------------------------|
| 650 (343) | 83 |
| 700 (371) | 81.5 |
| 750 (399) | 80.5 |
| 800 (427) | 79.5 |
| 850 (453) | 78.5 |

Intermediate values may be linearly interpolated.



High Pressure Equipment

Temperature Rating

Taper Seal Series Valves and Fittings

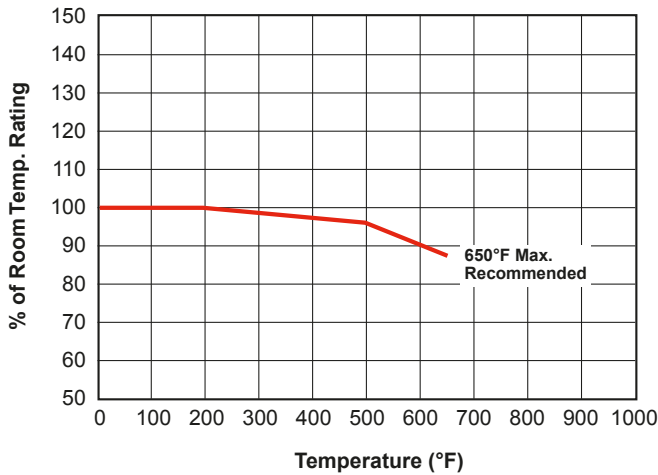

Pressure Rating Reduction

316 and 304 SS Components at Elevated Temperatures

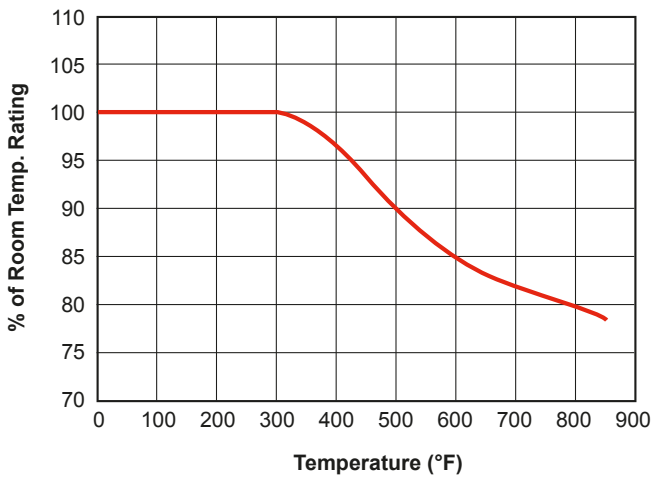

Micrometering Valve Flow

60-11HF4-V

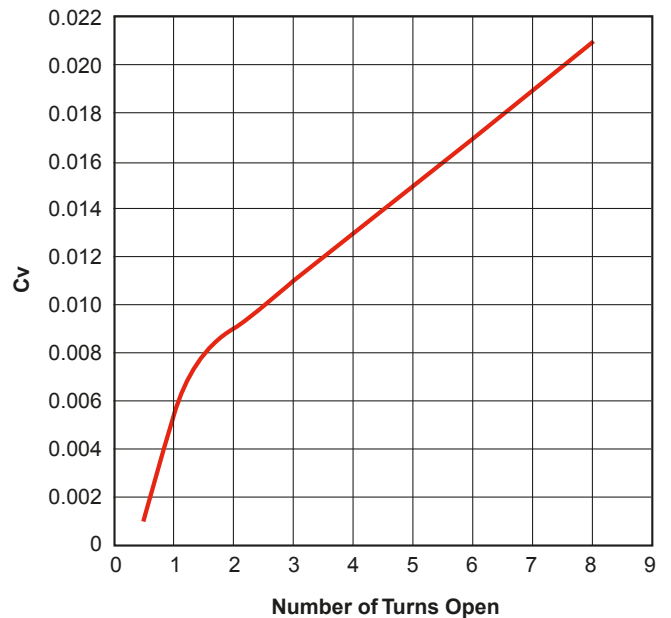

Valves • Fittings • Tubing



**High Pressure
Equipment
Company**



ISO 9001
CERTIFIED

**Oil & Gas
Products**



Oil and Gas Products

High Pressure Equipment Company has developed a complete line of valves and affiliated components specifically for the unique requirements of the oil and gas industry. We offer valves, fittings and tubing for use with sour oil and gas (H_2S) in a 10,000 psi, 20,000 psi and 30,000 psi series. Our "SGS" products are constructed of annealed 316 stainless steel and meet or exceed all requirements of NACE MR0175 and the American Petroleum Institute. For those applications where H_2S is not present, our standard line of valves, fittings and tubing will accommodate pressures to 150,000 psi.

Since 1954, HiP has been designing and manufacturing the highest quality and most dependable high pressure oil field products. Our ISO 9001 certified operation is part of a quality focus that has helped us gain the trust of many new oil and gas customers. And our on-time delivery and competitive pricing have made us integral partners in our customers' cost-reduction efforts.



Hastelloy & Other Exotic Material Products in Stock

We know that some oil and gas applications demand material performance beyond our "SGS" stainless steel products. In an effort to provide our customers with their material of choice and meet tight shipping deadlines, we maintain an inventory of Hastelloy and Monel valves and fittings.

Sour Oil & Gas Valves

- 1/4", 3/8" & 9/16" O.D. tube connections
- 10,000, 20,000 & 30,000 psi series
- Vee and regulating stem types
- Annealed 316 stainless steel construction
- Meet or exceed requirements of NACE MR0175

High Pressure Coned and Threaded Connections

HiP oil field products use a high pressure coned and threaded connection which accommodates the high temperatures, high pressures and extreme conditions common in these applications. These connections may be disassembled and retightened indefinitely.

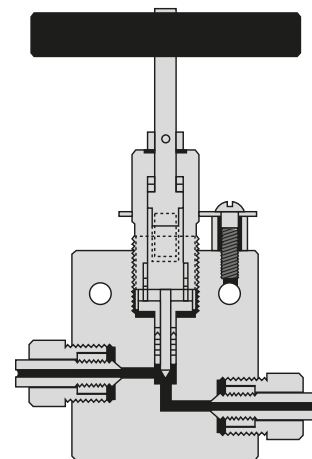

HF4 ($1/4$ "), HF6 ($3/8$ ") and HF9 ($9/16$ ")

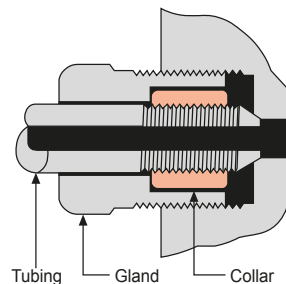

Two Way Straight Valves

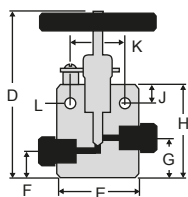

| Tubing | Catalog No. | psi | Connection | Orifice | D | E | F | G | H | J | K | L | Thickness |
|------------|--------------|--------|------------|---------|---------|--------|------|---------|---------|------|--------|-------|-----------|
| 1/4" O.D. | 30-11HF4-SGS | 20,000 | HF4 | 3/32" | 5 1/16" | 2" | 5/8" | 1" | 2 7/16" | 1/2" | 1 3/8" | 7/32" | 1" |
| 3/8" O.D. | 30-11HF6-SGS | 20,000 | HF6 | 1/8" | 5 1/16" | 2" | 5/8" | 1" | 2 7/16" | 1/2" | 1 3/8" | 7/32" | 1" |
| 9/16" O.D. | 30-11HF9-SGS | 20,000 | HF9 | 1/8" | 5 5/8" | 2 5/8" | 1" | 1 7/16" | 2 7/8" | 1/2" | 1 3/8" | 7/32" | 1 1/2" |
| 1/4" O.D. | 60-11HF4-SGS | 30,000 | HF4 | 1/16" | 5 1/16" | 2" | 5/8" | 1" | 2 7/16" | 1/2" | 1 3/8" | 7/32" | 1" |
| 3/8" O.D. | 60-11HF6-SGS | 30,000 | HF6 | 1/16" | 5 1/16" | 2" | 5/8" | 1" | 2 7/16" | 1/2" | 1 3/8" | 7/32" | 1" |
| 9/16" O.D. | 60-11HF9-SGS | 30,000 | HF9 | 1/16" | 5 5/8" | 2 5/8" | 1" | 1 7/16" | 2 7/8" | 1/2" | 1 3/8" | 7/32" | 1 1/2" |

Two Way Angle Valves

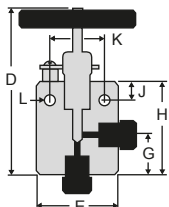

| Tubing | Catalog No. | psi | Connection | Orifice | D | E | F | G | H | J | K | L | Thickness |
|------------|--------------|--------|------------|---------|---------|--------|---|---------|----------|------|--------|-------|-----------|
| 1/4" O.D. | 30-12HF4-SGS | 20,000 | HF4 | 3/32" | 5 1/16" | 2" | — | 1" | 2 7/16" | 1/2" | 1 3/8" | 7/32" | 1" |
| 3/8" O.D. | 30-12HF6-SGS | 20,000 | HF6 | 1/8" | 5 1/16" | 2" | — | 1 3/8" | 2 13/16" | 1/2" | 1 3/8" | 7/32" | 1" |
| 9/16" O.D. | 30-12HF9-SGS | 20,000 | HF9 | 1/8" | 5 5/8" | 2 5/8" | — | 1 7/16" | 2 7/8" | 1/2" | 1 3/8" | 7/32" | 1 1/2" |
| 1/4" O.D. | 60-12HF4-SGS | 30,000 | HF4 | 1/16" | 5 1/16" | 2" | — | 1" | 2 7/16" | 1/2" | 1 3/8" | 7/32" | 1" |
| 3/8" O.D. | 60-12HF6-SGS | 30,000 | HF6 | 1/16" | 5 1/16" | 2" | — | 1 3/8" | 2 13/16" | 1/2" | 1 3/8" | 7/32" | 1" |
| 9/16" O.D. | 60-12HF9-SGS | 30,000 | HF9 | 1/16" | 5 5/8" | 2 5/8" | — | 1 7/16" | 2 7/8" | 1/2" | 1 3/8" | 7/32" | 1 1/2" |

Three Way Valves / Two Pressure Connections

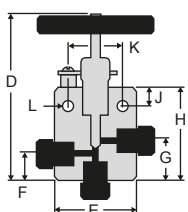

| Tubing | Catalog No. | psi | Connection | Orifice | D | E | F | G | H | J | K | L | Thickness |
|------------|--------------|--------|------------|---------|---------|--------|---------|--------|----------|------|--------|-------|-----------|
| 1/4" O.D. | 30-13HF4-SGS | 20,000 | HF4 | 3/32" | 5 1/16" | 2" | 5/8" | 1" | 2 7/16" | 1/2" | 1 3/8" | 7/32" | 1" |
| 3/8" O.D. | 30-13HF6-SGS | 20,000 | HF6 | 1/8" | 5 1/16" | 2" | 1" | 1 3/8" | 2 13/16" | 1/2" | 1 3/8" | 7/32" | 1" |
| 9/16" O.D. | 30-13HF9-SGS | 20,000 | HF9 | 1/8" | 6 1/16" | 2 5/8" | 1 7/16" | 1 7/8" | 3 5/16" | 1/2" | 1 3/8" | 7/32" | 1 1/2" |
| 1/4" O.D. | 60-13HF4-SGS | 30,000 | HF4 | 1/16" | 5 1/16" | 2" | 5/8" | 1" | 2 7/16" | 1/2" | 1 3/8" | 7/32" | 1" |
| 3/8" O.D. | 60-13HF6-SGS | 30,000 | HF6 | 1/16" | 5 1/16" | 2" | 1" | 1 3/8" | 2 13/16" | 1/2" | 1 3/8" | 7/32" | 1" |
| 9/16" O.D. | 60-13HF9-SGS | 30,000 | HF9 | 1/16" | 6 1/16" | 2 5/8" | 1 7/16" | 1 7/8" | 2 5/16" | 1/2" | 1 3/8" | 7/32" | 1 1/2" |

Three Way Valves / One Pressure Connection

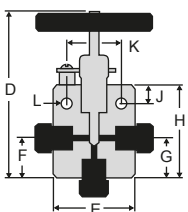

| Tubing | Catalog No. | psi | Connection | Orifice | D | E | F | G | H | J | K | L | Thickness |
|------------|--------------|--------|------------|---------|---------|--------|---------|---------|----------|------|--------|-------|-----------|
| 1/4" O.D. | 30-14HF4-SGS | 20,000 | HF4 | 3/32" | 5 1/16" | 2" | 1" | 1" | 2 7/16" | 1/2" | 1 3/8" | 7/32" | 1" |
| 3/8" O.D. | 30-14HF6-SGS | 20,000 | HF6 | 1/8" | 5 1/16" | 2" | 2" | 1 7/16" | 2 13/16" | 1/2" | 1 3/8" | 7/32" | 1" |
| 9/16" O.D. | 30-14HF9-SGS | 20,000 | HF9 | 1/8" | 5 5/8" | 2 5/8" | 2 3/16" | 1 7/16" | 2 7/8" | 1/2" | 1 3/8" | 7/32" | 1 1/2" |
| 1/4" O.D. | 60-14HF4-SGS | 30,000 | HF4 | 1/16" | 5 1/16" | 2" | 1" | 1" | 2 7/16" | 1/2" | 1 3/8" | 7/32" | 1" |
| 3/8" O.D. | 60-14HF6-SGS | 30,000 | HF6 | 1/16" | 5 1/16" | 2" | 1 3/8" | 1 3/8" | 2 13/16" | 1/2" | 1 3/8" | 7/32" | 1" |
| 9/16" O.D. | 60-14HF9-SGS | 30,000 | HF9 | 1/16" | 5 5/8" | 2 5/8" | 1 7/16" | 1 7/16" | 2 7/8" | 1/2" | 1 3/8" | 7/32" | 1 1/2" |

Three Way / Two Stem Connection Valves

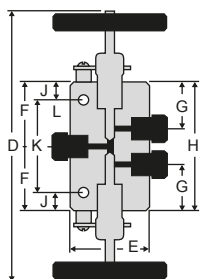

| Tubing | Catalog No. | psi | Connection | Orifice | D | E | F | G | H | J | K | L | Thickness |
|------------|--------------|--------|------------|---------|--------|--------|---------|---------|--------|------|--------|-------|-----------|
| 1/4" O.D. | 30-15HF4-SGS | 20,000 | HF4 | 3/32" | 9 1/4" | 2" | 1" | 1 7/16" | 3 3/4" | 1/2" | 2 3/4" | 7/32" | 1" |
| 3/8" O.D. | 30-15HF6-SGS | 20,000 | HF6 | 1/8" | 9 1/2" | 2" | 2" | 1 7/16" | 4" | 1/2" | 3" | 7/32" | 1" |
| 9/16" O.D. | 30-15HF9-SGS | 20,000 | HF9 | 1/8" | 9 5/8" | 2 5/8" | 2 3/16" | 1 7/16" | 4 3/8" | 1/2" | 3 3/8" | 7/32" | 1 1/2" |
| 1/4" O.D. | 60-15HF4-SGS | 30,000 | HF4 | 1/16" | 9 1/4" | 2" | 1 7/8" | 1 7/16" | 3 3/4" | 1/2" | 2 3/4" | 7/32" | 1" |
| 3/8" O.D. | 60-15HF6-SGS | 30,000 | HF6 | 1/16" | 9 1/2" | 2" | 2" | 1 7/16" | 4" | 1/2" | 3" | 7/32" | 1" |
| 9/16" O.D. | 60-15HF9-SGS | 30,000 | HF9 | 1/16" | 9 7/8" | 2 5/8" | 2 3/16" | 1 7/16" | 4 3/8" | 1/2" | 3 3/8" | 7/32" | 1 1/2" |

Replaceable Seat Valves

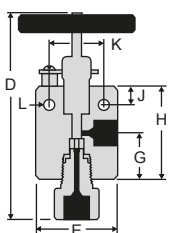

| Tubing | Catalog No. | psi | Connection | Orifice | D | E | F | G | H | J | K | L | Thickness |
|------------|----------------|--------|------------|---------|---------|--------|---|---------|----------|------|--------|-------|-----------|
| 1/4" O.D. | 30-12HF4-R-SGS | 20,000 | HF4 | 3/32" | 5 1/16" | 2" | — | 1" | 2 7/16" | 1/2" | 1 3/8" | 7/32" | 1" |
| 3/8" O.D. | 30-12HF6-R-SGS | 20,000 | HF6 | 1/8" | 5 1/16" | 2" | — | 1 3/8" | 2 13/16" | 1/2" | 1 3/8" | 7/32" | 1" |
| 9/16" O.D. | 30-12HF9-R-SGS | 20,000 | HF9 | 1/8" | 5 5/8" | 2 5/8" | — | 1 7/16" | 2 7/8" | 1/2" | 1 3/8" | 7/32" | 1 1/2" |
| 1/4" O.D. | 60-12HF4-R-SGS | 30,000 | HF4 | 1/16" | 5 1/16" | 2" | — | 1" | 2 7/16" | 1/2" | 1 3/8" | 7/32" | 1" |
| 3/8" O.D. | 60-12HF6-R-SGS | 30,000 | HF6 | 1/16" | 5 1/16" | 2" | — | 1 3/8" | 2 13/16" | 1/2" | 1 3/8" | 7/32" | 1" |
| 9/16" O.D. | 60-12HF9-R-SGS | 30,000 | HF9 | 1/16" | 5 5/8" | 2 5/8" | — | 1 7/16" | 2 7/8" | 1/2" | 1 3/8" | 7/32" | 1 1/2" |



Oil and Gas Accessories

Glands/Sleeves/Plugs/Elbows/Tees/Crosses

A complete range of elbows, tees, and crosses is available for use with sour oil and gas. Material is annealed 316 stainless steel.

All connection components and fittings are rated for 30,000 psi service. Standard tubing glands and collars are provided unless otherwise specified.

Connection Components

| Catalog No. | Tube Size | Gland | Catalog No. | Tube Size | Collar | Catalog No. | Tube Size | Plug |
|-------------|-----------|-------|-------------|-----------|--------|-------------|-----------|------|
| 60-2HM4-SGS | 1/4" | | 60-2H4-SGS | 1/4" | | 60-7HM4-SGS | 1/4" | |
| 60-2HM6-SGS | 3/8" | | 60-2H6-SGS | 3/8" | | 60-7HM6-SGS | 3/8" | |
| 60-2HM9-SGS | 9/16" | | 60-2H9-SGS | 9/16" | | 60-7HM9-SGS | 9/16" | |

High Pressure Elbows

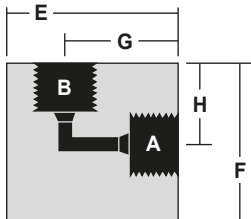

| Catalog No. | Pressure Rating psi | Connections | A-B | E | F | G | H | Thickness |
|--------------|---------------------|-----------------|-----|--------|--------|--------|--------|-----------|
| 60-22HF4-SGS | 30,000 | 1/4" O.D. TUBE | HF4 | 1 3/8" | 1 1/2" | 7/8" | 1" | 1" |
| 60-22HF6-SGS | 30,000 | 3/8" O.D. TUBE | HF6 | 1 3/4" | 1 1/2" | 1 1/4" | 1" | 1" |
| 60-22HF9-SGS | 30,000 | 9/16" O.D. TUBE | HF9 | 2 5/8" | 1 7/8" | 1 7/8" | 1 1/8" | 1 1/2" |

High Pressure Tees

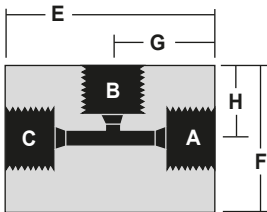

| Catalog No. | Pressure Rating psi | Connections | A-B-C | E | F | G | H | Thickness |
|--------------|---------------------|-----------------|-------|--------|---------|--------|---------|-----------|
| 60-23HF4-SGS | 30,000 | 1/4" O.D. TUBE | HF4 | 2" | 1 3/8" | 1" | 7/8" | 1" |
| 60-23HF6-SGS | 30,000 | 3/8" O.D. TUBE | HF6 | 2" | 1 9/16" | 1" | 1 1/16" | 1" |
| 60-23HF9-SGS | 30,000 | 9/16" O.D. TUBE | HF9 | 2 5/8" | 2 1/8" | 1 5/8" | 1 3/8" | 1 1/2" |

High Pressure Crosses

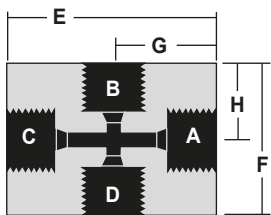

| Catalog No. | Pressure Rating psi | Connections | A-B-C-D | E | F | G | H | Thickness |
|--------------|---------------------|-----------------|---------|--------|--------|---------|---------|-----------|
| 60-24HF4-SGS | 30,000 | 1/4" O.D. TUBE | HF4 | 2" | 1 1/2" | 1" | 3/4" | 1" |
| 60-24HF6-SGS | 30,000 | 3/8" O.D. TUBE | HF6 | 2 1/8" | 2" | 1 1/16" | 1" | 1" |
| 60-24HF9-SGS | 30,000 | 9/16" O.D. TUBE | HF9 | 2 3/4" | 2 5/8" | 1 3/8" | 1 5/16" | 1 1/2" |

Union Couplings (Slip Type)

Union (slip Type) couplings are ideal for use in confined space installations. This design allows the entire coupling to be disconnected and slipped back over the tubing to facilitate assembly and disassembly. In installations where tubing is easily assembled, it is preferable (and less expensive) to use standard straight couplings (see accessories section). Sour oil and gas material is annealed 316 stainless steel. Standard tubing collars and glands are provided unless otherwise specified.

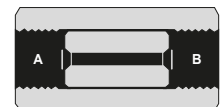

| Catalog No. | Pressure Rating psi | Connections | A | B | Length | Hex Size |
|----------------|---------------------|-------------------|-----|-----|--------|----------|
| 60-21HF4-U-SGS | 30,000 | 1/4" O.D. TUBING | HF4 | HF4 | 1 3/4" | 1" |
| 60-21HF6-U-SGS | 30,000 | 3/8" O.D. TUBING | HF6 | HF6 | 2" | 1" |
| 60-21HF9-U-SGS | 30,000 | 9/16" O.D. TUBING | HF9 | HF9 | 2 3/8" | 1 3/8" |

Bulkhead Couplings

Bulkhead couplings are designed specifically for passing a tubing connection through a panel or steel barricade. These couplings include a locknut as shown. Material is annealed 316 stainless steel. Standard tubing collars and glands are included unless otherwise specified.

| Catalog No. | Pressure Rating psi | Connections | Panel Hole | A | B | Length | Hex Size | Outside Thread |
|----------------|---------------------|-------------------|------------|-----|-----|--------|----------|----------------|
| 60-21HF4-B-SGS | 30,000 | 1/4" O.D. TUBING | 15/16" | HF4 | HF4 | 2" | 1" | 7/8" - 14 |
| 60-21HF6-B-SGS | 30,000 | 3/8" O.D. TUBING | 1 1/8" | HF6 | HF6 | 2 3/8" | 1 3/8" | 1 1/16" - 12 |
| 60-21HF9-B-SGS | 30,000 | 9/16" O.D. TUBING | 1 11/16" | HF9 | HF9 | 2 3/4" | 1 7/8" | 1 5/8" - 12 |

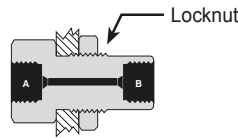

Caps

Tubing end caps are offered for use in sealing off tubing ends either for temporary use or permanent use such as on small volume reservoirs. Standard material is annealed 316 stainless steel. Standard tubing collars and glands are provided unless otherwise specified.

| Catalog No. | Pressure Rating psi | Connections | A | Length | Hex Size |
|----------------|---------------------|-------------------|-----|--------|----------|
| 60-21HF4-C-SGS | 30,000 | 1/4" O.D. TUBING | HF4 | 7/8" | 3/4" |
| 60-21HF6-C-SGS | 30,000 | 3/8" O.D. TUBING | HF6 | 1 1/4" | 1" |
| 60-21HF9-C-SGS | 30,000 | 9/16" O.D. TUBING | HF9 | 1 1/2" | 1 3/8" |



Line Filters

The line filters as shown utilize sintered stainless steel filter discs 3 pc./set. Porosities are available as per the chart to the right. If not otherwise specified, 100 micron filter discs are supplied. (One micron = 0.001 millimeters). Material of bodies and end covers is annealed 316 stainless steel. Standard tubing glands and collars are provided unless otherwise specified.

| Catalog No. | Pressure Rating psi | Connections | Length | Hex Size | Micron Size Filter Available | | | | | |
|---------------|---------------------|---------------------|--------|----------|------------------------------|---|---|----|----|-----|
| | | | | | 0.5 | 2 | 5 | 10 | 40 | 100 |
| 60F-51HF4-SGS | 30,000 | 1/4" HIGH PRESSURE | 5 1/4" | 1 1/2" | ● | ● | ● | ● | ● | ● |
| 60F-51HF6-SGS | 30,000 | 3/8" HIGH PRESSURE | 5 1/4" | 1 1/2" | ● | ● | ● | ● | ● | ● |
| 60F-51HF9-SGS | 30,000 | 9/16" HIGH PRESSURE | 5 1/4" | 1 1/2" | ● | ● | ● | ● | ● | ● |

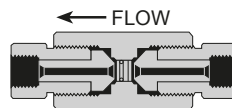

Ball Check Valves

Ball type check valves insure flow in one direction only. Material for bodies and covers is annealed 316 stainless steel, the ball is 17-4PH. Standard tubing glands and collars are provided unless otherwise specified.

| Catalog No. | psi | Connections | Length | Hex |
|--------------|--------|---------------------|--------|--------|
| 60-41HF4-SGS | 30,000 | 1/4" HIGH PRESSURE | 4 1/4" | 1 1/2" |
| 60-41HF6-SGS | 30,000 | 3/8" HIGH PRESSURE | 4 5/8" | 1 1/2" |
| 60-41HF9-SGS | 30,000 | 9/16" HIGH PRESSURE | 5 1/8" | 1 1/2" |

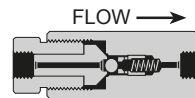

Soft Seat Check Valves

Soft seat check valves insure flow in one direction only and can be mounted in any position. These are highly reliable for both gas and liquid service. Standard O-ring (soft seat) material for the sealing surface is Buna-N (nitrile) with other materials including Teflon and Viton available on request. Temperature is limited by the choice of O-ring material. Material of all other parts is annealed 316 stainless steel. Standard glands and collars are provided unless otherwise specified.

| Catalog No. | psi | Connections | Length | Hex |
|----------------|--------|---------------------|---------|--------|
| 30-41HF4-T-SGS | 20,000 | 1/4" HIGH PRESSURE | 3 7/8" | 1" |
| 30-41HF6-T-SGS | 20,000 | 3/8" HIGH PRESSURE | 3 7/8" | 1" |
| 30-41HF9-T-SGS | 20,000 | 9/16" HIGH PRESSURE | 4 1/4" | 1 3/8" |
| 60-41HF4-T-SGS | 30,000 | 1/4" HIGH PRESSURE | 4 9/16" | 1 1/2" |
| 60-41HF6-T-SGS | 30,000 | 3/8" HIGH PRESSURE | 4 9/16" | 1 1/2" |
| 60-41HF9-T-SGS | 30,000 | 9/16" HIGH PRESSURE | 5 1/16" | 1 1/2" |

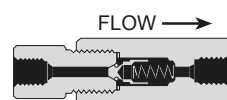



Oil and Gas Products

Adapters

Connect different sizes of tubing or tubing and pipe with our female-to-female couplings, female-to-male adapters, male-to-male adapters, reducer couplings and thermocouple adapters. For complete adapter information, see accessories section of full line catalog.

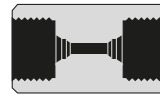

Female to Female

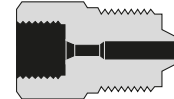

Female to Male



Male to Male

Tubing

For sour gas applications, our tubing is annealed stainless steel, available for all standard valve and fitting sizes, and in any length specified.

For sweet applications, HiP tubing is cold drawn, seamless and supplied in the hard condition (not annealed). Tubing is stocked in lengths of 18 to 22 feet but may be ordered in shorter lengths with **no additional cutting charge**.



| | Tubing Size | Working Pressure psi | Type of Connection Used | Material | Catalog Order Number |
|--------------|-------------------------|----------------------|---------------------------|----------|----------------------|
| 1/4" | 1/4" O.D. x 0.083" I.D. | 30,000 | 1/4" HIGH PRESSURE (HF4) | 316 SS | 60-9H4-316-SGS |
| | | | | 304 SS | 60-9H4-304-SGS |
| 3/8" | 3/8" O.D. x 1/8" I.D. | 30,000 | 3/8" HIGH PRESSURE (HF6) | 316 SS | 60-9H6-316-SGS |
| | | | | 304 SS | 60-9H6-304-SGS |
| 9/16" | 9/16" O.D. x 3/16" I.D. | 30,000 | 9/16" HIGH PRESSURE (HF9) | 316 SS | 60-9H9-316-SGS |
| | | | | 304 SS | 60-9H9-304-SGS |

Coned and Threaded Nipples

Connection-ready nipples are available in annealed and standard tubing for all valve and fitting sizes, and in any length specified. Nipples are not furnished with collars and glands, unless specified at time of order. Sour gas nipples are annealed 316 SS.



| Length ↓ | Tubing Size (O.D. x I.D.) | | |
|-------------|---------------------------|---------------|---------------|
| | 1/4" x 0.083" | 3/8" x 1/8" | 9/16" x 3/16" |
| psi → | 30,000 psi | 30,000 psi | 30,000 psi |
| 2 3/4" | 60-HM4-2.75-SGS | | |
| 3" | | 60-HM6-3-SGS | |
| 4" | | | 60-HM9-4-SGS |
| 6" | 60-HM4-6-SGS | 60-HM6-6-SGS | 60-HM9-6-SGS |
| 8" | 60-HM4-8-SGS | 60-HM6-8-SGS | 60-HM9-8-SGS |
| 10" | 60-HM4-10-SGS | 60-HM6-10-SGS | 60-HM9-10-SGS |
| 12" | 60-HM4-12-SGS | 60-HM6-12-SGS | 60-HM9-12-SGS |

Wellhead Gauge and Bleed Valves

Wellhead Gauge Valves

- One inlet and three outlet ports
- Packing located below stem threads
- Metal-to-metal seat for bubble tight shut-off
- Two piece non-rotating stem for standard service valves
- One piece stem for sour gas service
- Designed for line sampling or instrument calibration

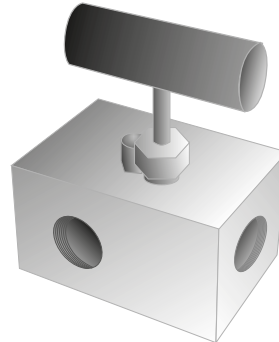

| Catalog No. | Pressure Rating psi | Service | Connections | Material | Inlet Port | Outlet Port |
|-------------|---------------------|------------------|---------------------|-----------------|------------|-------------|
| 30GVHF9 | 30,000 | Standard | 9/16" HIGH PRESSURE | 316 SS | HF9 | HF9 |
| 30GVHF9-SGS | 20,000 | H ₂ S | | Annealed 316 SS | | |

Bleed Valves

- Tee handle for easy operation
- Vent port tapped for safe plumbing
- Positive blow-out prevention on stem
- Metal-to-metal seat for bubble tight shut-off
- One piece hex construction for easy installation
- Compatible with standard API test and gauge connections for 20,000 psi
- Designed for pressure bleeding



| Catalog No. | Pressure Rating psi | Service | Connections | Material | Inlet Port | Outlet Port |
|-------------|---------------------|------------------|------------------------------------------|-----------------|------------|-------------|
| 30BVHM9 | 30,000 | Standard | 9/16" HIGH PRESSURE x 1/8" Female NPT | 316 SS | HM9 | NFA |
| 30BVHM9-SGS | 20,000 | H ₂ S | | Annealed 316 SS | | |



Specialty Valves

HiP produces many valves engineered for specific requirements and operating conditions. Among the specialty valves we offer are high temperature valves, micro control metering valves, pipe connection valves and male bottom connection valves. Our two most popular oil and gas specialty valves are described below.

Ball Valves

These valves provide shut-off of oil, liquid or gas flow through 20,000 psi. HiP ball valves are available in two way and three way configurations.

Subsea Ball Valves

Designed for extreme pressures and harsh environments, the industry's broadest line of subsea ball valves for 10, 15 and 20,000 psi.

Relief Valves

Relief valves protect a system from over-pressure damage and failure. These valves are offered in pressures from 3,000 to 30,000 psi.



DANMARK
Metalgangen 13
DK-2690 Karlslunde
Danmark
+(45) 73 84 12 30
info@pgflowteknik.dk
www.pgflowteknik.dk

SVERIGE
www.pgflowteknik.se
+(46) 70 684 1230

The logo for Indutrade, consisting of a stylized 'I' symbol made of three slanted parallel lines followed by the word 'Indutrade' in a bold, white, sans-serif font.

Indutrade

PG FLOWTEKNIK SCANDINAVIA - EN DEL AF INDUTRADE