

# Bellows Valves BL-series

**Hy-Lok**



**FLOWTEKNIK**  
SCANDINAVIA APS



# Hy-Lok



## Design & Engineering

- All-metal seal bellows valves at the atmosphere
- Maximum working pressure up to 500 psig (34.4 bar)
- Temperature rating is up to 200°F (93°C)
- ZCR, tube butt weld, and Hy-Lok tube fitting
- End connection size from 1/4 to 1/2
- 100% helium leak tested

## Application

- Semiconductor
- Biotech
- Pharmaceutical

## Features

### Upper & Lower Stem

- Ball bearing application between up and low stem
- Smooth operation

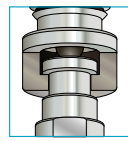

### Bonnet seals to body without gasket

### Stem Tip Ass'y

- Excellent chemical resistance
- Nonrotating stem tip
- Long cycle life
- Applicable metal stem tip

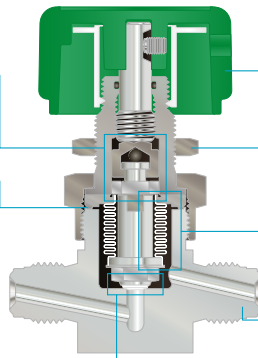
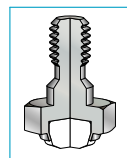

### Round/Toggle Handle & Pneumatic Actuator Panel Mounting

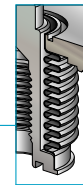

### Bellows Welded Ass'y

- Precision formed metal bellows
- Electro polishing processing
- Long cycle life

### Body

- 316L VOD Stainless Steel
- Electro polishing processing
- Variable end connections

## Materials of Construction

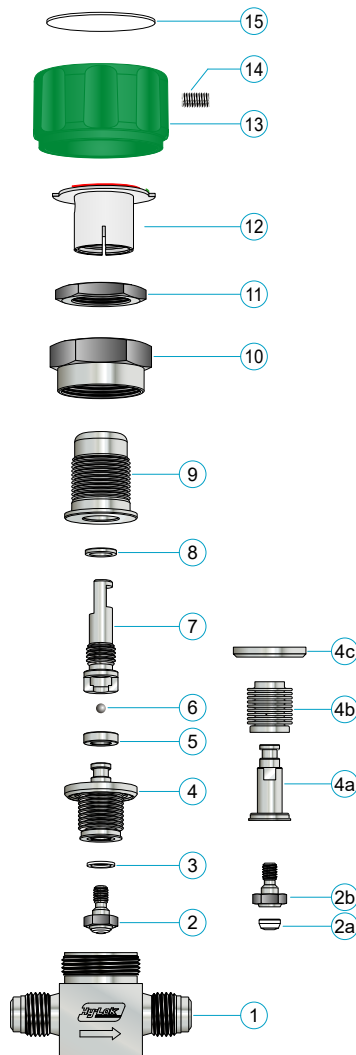

No.	Description	Material / ASTM Specification
* 1	Body	316L VOD / A479
* 2	Stem Tip Assembly	
* 2a	Stem Tip	PCTFE
* 2b	Adapter	Type 316L / A479
* 3	Gasket	PCTFE
* 4	Bellows Welded Assembly	
* 4a	Lower Stem	Type 316L / A479
* 4b	Bellows	Type 321 / A269
* 4c	Weld Ring	Type 316L / A479
5	Stem Guide	Type 316 / A479
6	Ball Bearing	Stainless Steel 316
7	Upper Stem	Type 316 / A479
8	O-Ring	VITON
9	Bonnet	Type 316 / A479
10	Packing Nut	Type 316 / A479
11	Lock Nut	Type 316 / A479
12	Indicator	Nylon
13	Handle	Aluminum
14	Handle Screw	Stainless Steel 304
15	Handle Cap	Nylon

"\*" marked are wetted parts

## Specification

Series	Orifice in. (mm)	Cv	Pressure Rating psig (bar)	Temp. Rating °F (°C)
BLSV1	0.157 (4.0)	0.30	Round Handle : 500 (34.4) Toggle Handle : 125 (8.6) Normally Open : 400 (27.5)	-20 ~ 200 (-28 ~ 93)
BLSV2	0.276 (7.0)	0.65	Normally Close : 125 (8.6) Open & Close : 400 (27.5)	

## Internal Surface Grade

Grade	Designator	Roughness Average Ra. (E.P)	Packing Standard Class 10
B.A.	B	0.25 μm (10 μin)	Double
High	H	0.13 μm ( 5 μin)	

Grade "High" is standard.

## Cleaning & Testing

Passivation is done at Nitrogen environment. Fine cleaning is done by Ultrasonic cleansing with resistivity over 18MΩ. D.I water after finishing the passivation. Inboard helium leak tested to a rate of 4 x 10<sup>-9</sup> cm<sup>3</sup>/s.

## Assembly & Packaging

Assembly and Packaging is performed in the clean room of Class 10. Valves are packed with anti-static polyethylene bag that is pressured into the high purity nitrogen gas.

## Dimensions

All Dimensions are in millimeters, except for the O.D size. In case of the end connection for Hy-Lok tube fitting, dimensions shown with Hy-Lok nuts in finger-tight position, where applicable.

### Round Handle

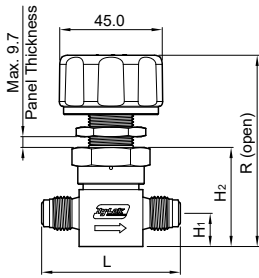

Male ZCR Fitting

### Toggle Handle

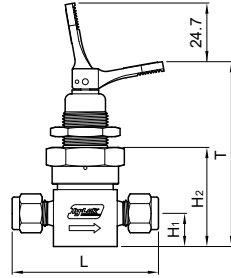

Hy-Lok Tube Fitting

### Pneumatic Actuator

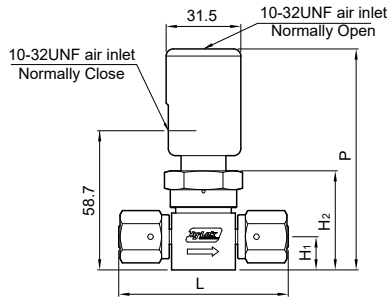

Female ZCR Fitting

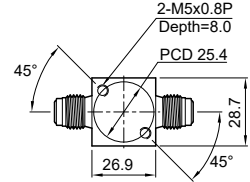

Bottom Mounting

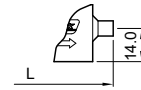

Tube Butt Weld

End Connection	Ordering No.	Orifice	O.D	L	H1	H2	R	T	P
Male ZCR Fitting	BLSV1VM-4	4.0	1/4"	58.5	14.0	41.8	83.4	80.3	88.6
	BLSV2VM-8	7.0	1/2"	65.0	16.0	45.8	87.4	84.3	92.6
Hy-Lok Tube Fitting	BLSV1H-4	4.0	1/4"	62.5	14.0	41.8	83.4	80.3	88.6
	BLSV1H-6	4.0	3/8"	65.5	14.0	41.8	83.4	80.3	88.6
	BLSV2H-8	7.0	1/2"	71.1	14.0	41.8	83.4	80.3	88.6
Female ZCR Fitting	BLSV1VF-4	4.0	1/4"	74.7	11.4	41.8	83.4	80.3	88.6
	BLSV2VF-8	7.0	1/2"	75.7	16.0	45.8	87.4	84.3	92.6
Tube Butt Weld	BLSV1BW-4	4.0	1/4"	44.2	11.4	41.8	83.4	80.3	88.6
	BLSV1BW-6	4.0	3/8"	44.2	11.4	41.8	83.4	80.3	88.6
	BLSV2BW-6	7.0	3/8"	44.2	14.0	41.8	83.4	80.3	88.6
	BLSV2BW-8	7.0	1/2"	44.2	14.0	41.8	83.4	80.3	88.6

## Maintenance Kits

All Dimensions are in millimeters, except for the O.D size. In case of the end connection for Hy-Lok tube fitting, dimensions shown with Hy-Lok nuts in finger-tight position, where applicable.

### Stem Tip Kits



Ordering number is the following.

Ordering No.	Orifice	Stem Tip Material
BLSV1STA-PCTFE	4.0 mm	PCTFE
BLSV2STA-PCTFE	7.0 mm	PCTFE

### Pneumatic Actuator Kits

Ordering number is the following.

Ordering No.	Series	Description
BLSV1-PO	BLSV1, BLSV2	Normally Open
BLSV1-PC		Normally Close
BLSV1-PD		Open and Close

### Bellows Welded Kits

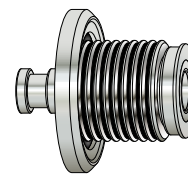

- Bellows, lower stem and weld ring are welded.
- Ordering number is BLSV-BELS that applied to both BLSV1 and BLSV2 Series.

## Flow Data at 70°F (20°C)

### Air & Water Flow Data

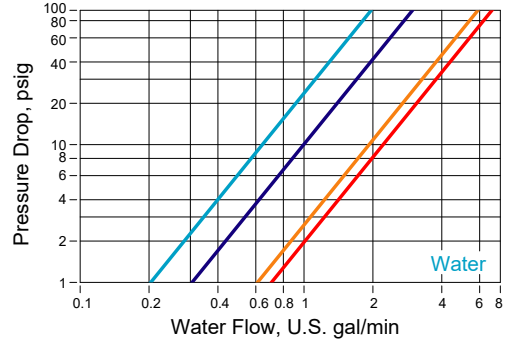
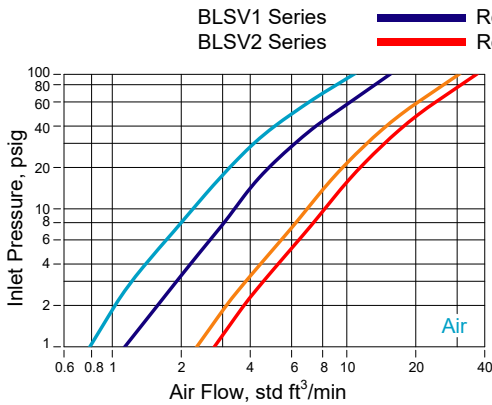

### Round Handle Flow Coefficient at Turns Open

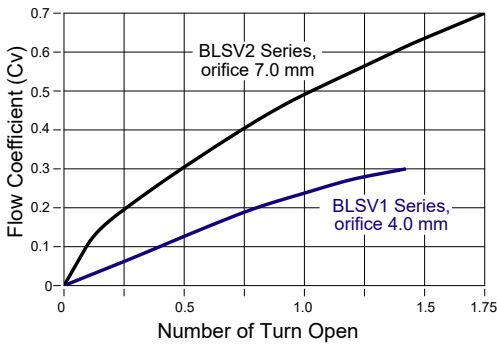

### Pneumatic Actuator Performance

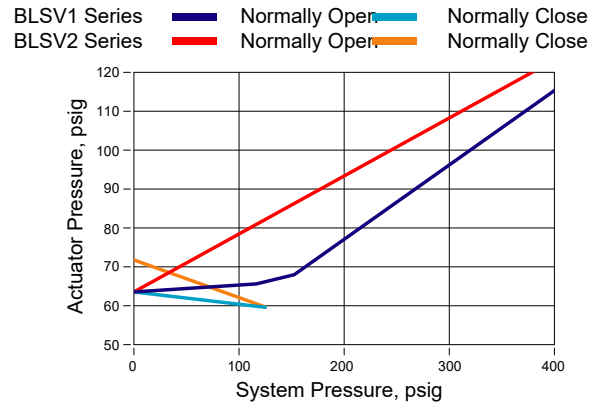

## Ordering Information

<b>BLSV</b>	<b>1</b>	<b>VM</b>	<b>S</b>	<b>4</b>	<b>R</b>	<b>H</b>	<b>SM6L</b>
<b>Valve Series Designator</b> • BLSV - Bellows Valve	<b>Flow Method</b> • 1 - orifice 4.0 mm • 2 - orifice 7.0 mm	<b>End Connection</b> • VM - Male ZCR Fitting • BW - Tube Butt Weld • H - Hy-Lok Tube Fitting • VF - Female ZCR Fitting	<b>Stem Tip</b> • Nil - PCTFE • S - TYPE 316 ASTM A479	<b>Size</b> • 4 - 1/4" • 6 - 3/8" • 8 - 1/2"	<b>Pneumatic Actuator</b> • R - Round Handle • T - Toggle Handle • PO - Pneumatic Actuator (Normally Open) • PC - Pneumatic Actuator (Normally Close) • PD - Pneumatic Actuator (Open & Close)	<b>Surface Grade</b> • Nil - Grade "B.A" • H - Grade "High"	<b>Body Material Designator</b> • SM6L - Single Vacuum Melt 316L ASTM A479

### SAFETY in VALVE SELECTION

Proper installation, materials compatibility, operation and maintenance of these valves are the responsibility of the user. The total system design must be taken into consideration to ensure optimal performance and safety.



Metalgangen 13  
DK-2690 Karlslunde  
Denmark  
Phone (+45) 73 84 12 30  
[info@pgflowteknik.dk](mailto:info@pgflowteknik.dk)  
[www.pgflowteknik.dk](http://www.pgflowteknik.dk)